

























ELEMENTOS GENERALES · GENERAL ELEMENTS · ELEMENTS GENERAUX	2
CHASIS · FRAME · CHASSIS	2
MOSQUETONES · AUTOLOCK SHACKLES · MOUSQUETONS	6
BRAZOS · ARMS · BRAS	6
ARRANQUE · STARTER · DÉMARREUR	6
ACEITE SINTÉTICO · SYNTHETIC OIL · HUILE SYNTHÉTIQUE	7
DEPOSITO · FUEL TANK · RÉSERVOIR À ESSENCE	7
RED PROTECCION · PROTECTION NET · FILET DE PROTECTION	9
ACELERADOR · ACCELERATOR · POIGNÉE DE GAZ	12
ACCESORIOS · ACCESSORIES · ACCESSOIRES	13
PARACAIDAS · PARACHUTE · PARACHUTE	13
CHALECO SALVAVIDAS · LIFE JACKET · GILET DE SAUVETAGE	13
TACÓMETRO/SENSOR · TACHOMETER/SENSOR · COMPTE-TOUR/THERMOMÈTRE	13
SISTEMA BIPLAZA · COMPANY SYSTEM · COMPANY SYSTEME	14
SILLA · HARNESS · SELLETTE	14
FUNDAS DE TRANSPORTE · LUGGAGE BAG · HOUSSE DE TRANSPORT	14
TRIKE · TRIKE · TRIKE	15
PARAPENTES · GLIDERS · PARAPENTES	20
HELICES · PROPELLERS · HELICES	20
CARBURADORES · CARBURETTORS · CARBURATEURS	25
TOP 80	26
ATOM 80	31
FLY 100 EVO	43
ROS 125	51
RM 80	57
PA 125	58
SAFARI 125	74
MOSTER 185 CLASSIC	84
MOSTER 185 PLUS	88
MOSTER 185 DUAL	92
FUERA DE LOS DESPIECES VITTORAZI MOSTER · OUT OF VITTORAZI MOSTER EXPLODED VIEWS · HORS VUES ÉCLATÉES VITTORAZI MOSTER	108
F200	109
THOR 80	111
THOR 130	118
THOR 190	120
THOR 200	121
THOR 250	123
CARBURADOR PWKØ28 · PWKØ28 CARBURATOR · CARBURATEUR PWKØ28	126
FUERA DE LOS DESPIECES POLINI · OUT OF POLINI EXPLODED VIEWS · HORS VUES ÉCLATÉES POLINI	146
HERRAMIENTAS POLINI · POLINI TOOLS · OUTILS POLINI	147
MERCHANDISING · MERCHANDISING · MERCHANDISING	149
ROPA · CLOTHES · VÊTEMENTS	149
ADHESIVO PARAPENTE · PARAGLIDING STICKER · AUTOCOLLANTS PARAPENTE	150
ADHESIVO · STICKER · AUTOCOLLANTS	150
BANDERA GOTA · DROP FLAG · DRAPEAU GOUTTE	151







	A21B	CLIP DE PLASTICO CONEXIÓN CHASIS (Unidad) PLASTIC CLIP FOR FRAME (Unit) CLIP PLASTIQUE CONNECTION CHASSIS (Unité)	8,00 €
	A21BS	CLIP DE PLASTICO INFERIOR CONEXIÓN PARA EL CHASIS "SINGLE" (Unidad) LOWER PLASTIC CLIP FOR "SINGLE" FRAME (Unit) CLIP PLASTIQUE INFERIEUR CONNECTION CHASSIS "SINGLE" (Unité)	8,40 €
	A35L	PERNO DE UNION LARGO 12 Ø LONG PERNO 12 Ø PERNO LONG 12 Ø	3,75 €
	A35C	PERNO DE UNION CORTO 12 Ø SHORT PERNO 12 Ø PERNO COURT 12 Ø	3,50 €
	A35A	PERNO DE UNION 14 Ø PERNO 14 Ø PERNO 14 Ø	2,00 €
	A36	PERNO DE UNION 16 Ø PERNO 16 Ø PERNO 16 Ø	4,00 €
	A102	TAPÓN TUBO 12 Ø TUBE CAP 12 Ø BOUCHON TUBE 12 Ø	3,00 €
	A101	PERNO DE UNION BISAGRA 12 Ø UNION PERNO WITH HINGE 12 Ø PERNO D'UNION AVEC CHARNIERE 12 Ø	2,00 €
	A100	PERNO DE UNION BISAGRA 14 Ø UNION PERNO WITH HINGE 14 Ø PERNO D'UNION AVEC CHARNIERE 14 Ø	2,00 €
	A52	ANILLA DE JARCIA JARCIA CLIP ANNEAU DE JARCIA	1,50 €
	A56	CLIP SEGURIDAD BARRA SEGURIDAD CHASIS 3 / 4 PARTES SECURITY CLIP FOR LOWER BAR OF 3 / 4 PARTS FRAME CLIP DE SECURITÉ POUR BARRE INFÉRIEURE CHASSIS 3/4 PARTIES	2,00 €
	A105	BARRA DE SILLA ANTIPAR DE ALUMINIO ANONIZADO (CHASIS PAP: RM80, PA125, MOSTER) ANODIZED ALUMINIUM ANTIPAR HARNESS BAR (PAP FRAME: RM80, PA125, MOSTER) BARRE ANTI PAR EN ALUMINIUM ANODISÉE POUR LA SELLETTE (CHASSIS PAP: RM80, PA125, MOSTER)	39,00 €
	A105PO	BARRA DE SILLA ANTIPAR DE ALUMINIO ANONIZADO (CHASIS PAP: POLINI) ANODIZED ALUMINIUM ANTIPAR HARNESS BAR (PAP FRAME: POLINI) BARRE ANTI PAR EN ALUMINIUM ANODISÉE POUR LA SELLETTE (CHASSIS PAP: POLINI)	39,00 €
	AC046S	BARRA REFUERZO CHASIS PAP RACING UPPER STICK PAP RACING FRAME BARRE RENFORT CHASSIS PAP RACING	40,00 €
	AC046SM	BARRA REFUERZO MOSTER CHASIS PAP "SINGLE" 1400mm (5 PARTES) UPPER STICK MOSTER "SINGLE" PAP FRAME 1400mm (5 PARTS) BARRE RENFORT MOSTER CHASSIS PAP "SINGLE" 1400mm (5 PARTIES)	50,00 €
	AC046SI	BARRA DE REFUERZO CHASIS SINGLE CON INSTALACIÓN SINGLE FRAME REINFORCED BAR WITH INSTALLATION BARRE DE RENFORT CHÂSSIS SINGLE AVEC INSTALLATION	60,00 €
	TK029	DOBLE ARO TRIKE (CHASIS 1500 MOTOR THOR250). NO INCLUYE TK002/16. TRIKE DOUBLE RING (1500 FRAME THOR250 MOTOR). TK002/16 NOT INCLUDED. DOUBLE CERCEAU TRIKE (CHASSIS 1500 MOTEUR THOR250). NON INCLU TK002/16.	175,00 €
	A46V	BARRA DE REFUERZO VERTICAL. VERTICAL REINFORCED BAR BARRE DE RENFORT VERTICALE	31,25 €
	VM021K	KIT SEPARADORES MOTOR MOSTER Y SAFARI ALUMINIO 30 X 42 (INCLUYE TORNILLOS M8X55 + ARANDELAS) 4 UNIDADES ALUMINIUM MOSTER & SAFARI MOTOR SEPARATOR 30 X 42 KIT (SCREWS M8X55 + WASHERS INCLUDE) 4 UNITIES KIT ENTRETOISE MOTEUR MOSTER ET SAFARI ALUMINIUM NOIR 30 X 42 (INCLUS VIS M8X55 + RONDELLE) 4 UNITÉES	38,00 €

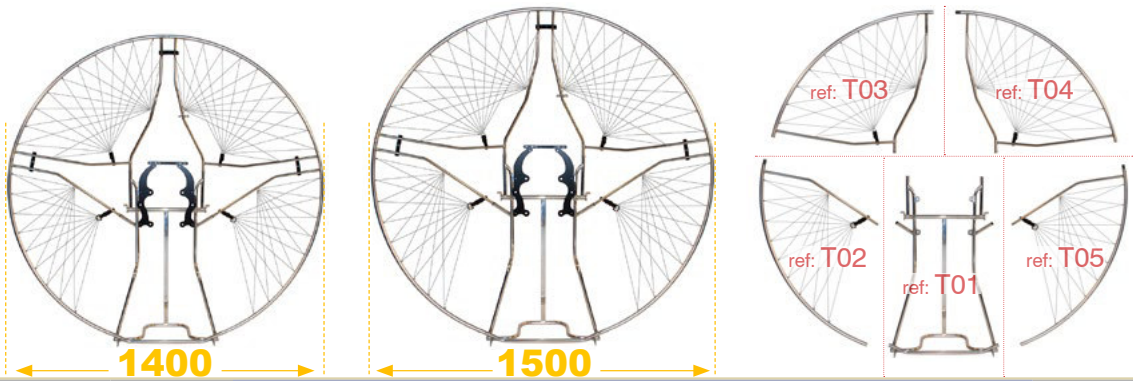







	T06	CLIP DE PLASTICO CONEXIÓN CHASSIS TINOX (UNIDAD) PLASTIC CLIP FOR TINOX FRAME (UNIT) CLIP PLASTIQUE CONNECTION CHASSIS TINOX (UNITÉ)	10,00 €
	T07	PUSH PIN CHASSIS TINOX PUSH PIN TINOX FRAME PUSH PIN CHASSIS TINOX	20,00 €
	T08	PIN CHASSIS TINOX PIN TINOX FRAME PIN CHASSIS TINOX	2,50 €
	T09	PERNO DE UNION CHASSIS 1400 Y 1500 TINOX 14 Ø PERNO CHASSIS 1400 Y 1500 TINOX FRAME 14 Ø PERNO CHASSIS 1400 Y 1500 TINOX 14 Ø	3,12 €
	T09A	PERNO DE UNION CHASSIS 1400 TINOX EN INOX 12 Ø PERNO CHASSIS 1400 INOX TINOX FRAME 12 Ø PERNO CHASSIS 1400 TINOX EN INOX 12 Ø	3,12 €
	T10D	SEPARADOR BRAZO TINOX DERECHO TINOX ARM RIGHT SPACER SÉPARATEUR DROIT BRAS TINOX	14,50 €
	T10I	SEPARADOR BRAZO TINOX IZQUIERDO TINOX ARM LEFT SPACER SÉPARATEUR GAUCHE BRAS TINOX	14,50 €
	T11	PLACAS SOPORTE MOTOR CHASSIS TINOX PLAQUES DE SUPPORT DU MOTEUR CHÂSSIS TINOX ENGINE SUPPORT PLATES TINOX FRAME	132,00 €
	VM021K	KIT SEPARADORES MOTOR Moster y Safari ALUMINIUM 30 X 42 (INCLUYE TORNILLOS M8X55 + ARANDELAS) 4 Uds. ALUMINIUM Moster & Safari MOTOR SEPARATOR 30 X 42 KIT (SCREWS M8X55 + WASHERS INCLUDE) 4 Unities KIT ENTRETOISE moteur Moster et Safari ALUMINIUM NOIR 30 X 42 (INCLUS VIS M8X55 + RONDELLE) 4 Unités	38,00 €

TINOX

TITANIO · TITANIUM · TITANE









	TX-MS	CHASSIS TINOX 1400 TITANIO (MOSTER, SAFARI, ATOM Y PA125) COMPLETE TINOX 1400 TITANIUM FRAME (MOSTER, SAFARI, ATOM & PA125) CHASSIS TINOX 1400 TITANE (MOSTER, SAFARI, ATOM ET PA125)	1.312,50 €
	TX-P	CHASSIS TINOX 1400 TITANIO (POLINI) COMPLETE TINOX 1400 TITANIUM FRAME (POLINI) CHASSIS TINOX 1400 TITANE (POLINI)	1.375,00 €
	TXG-MS	CHASSIS TINOX 1500 TITANIO (MOSTER, SAFARI, ATOM Y PA125) COMPLETE TINOX 1500 TITANIUM FRAME (MOSTER, SAFARI, ATOM & PA125) CHASSIS TINOX 1500 TITANE (MOSTER, SAFARI, ATOM ET PA125)	1.412,50 €
	TXG-P	CHASSIS TINOX 1500 TITANIO (POLINI) COMPLETE TINOX 1500 TITANIUM FRAME (POLINI) CHASSIS TINOX 1500 TITANE (POLINI)	1.475,00 €
	T01	PIE CHASSIS 1400 TINOX MAIN PART TINOX FRAME 1400 BASE DE CHÂSSIS 1400 TINOX	325,00 €
	TG01	PIE CHASSIS 1500 TINOX MAIN PART TINOX FRAME 1500 BASE DE CHÂSSIS 1500 TINOX	325,00 €

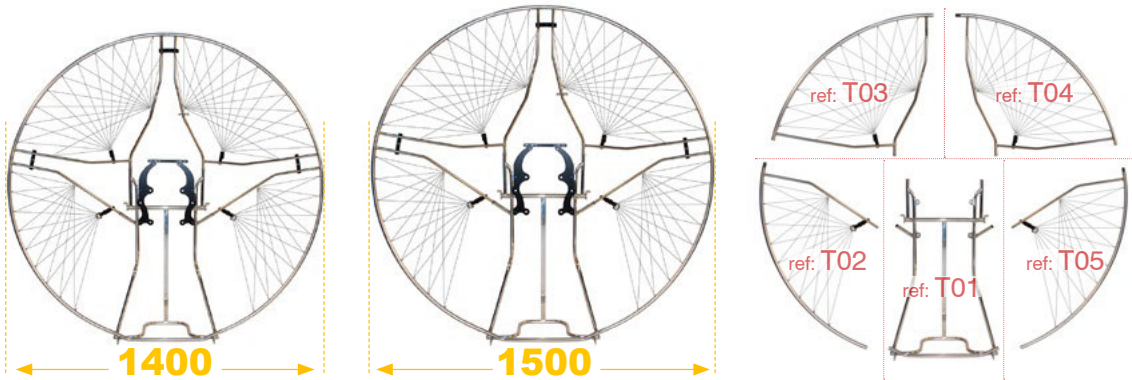







	T02	PARTE INFERIOR IZQUIERDA (POSICIÓN DE VUELO) CHASIS TINOX 1400 TITANIO LEFT LOWER PART (FLIGHT POSITION) 1400 TITANIUM TINOX FRAME PARTIE INFÉRIEURE GAUCHE (POSITION DE VOL) CHÂSSIS TINOX 1400 TITANE	187,50 €
	TG02	PARTE INFERIOR IZQUIERDA (POSICIÓN DE VUELO) CHASIS TINOX 1500 TITANIO LEFT LOWER PART (FLIGHT POSITION) 1500 TITANIUM TINOX FRAME PARTIE INFÉRIEURE GAUCHE (POSITION DE VOL) CHÂSSIS TINOX 1500 TITANE	207,50 €
	T03	PARTE SUPERIOR IZQUIERDA (POSICIÓN DE VUELO) CHASIS TINOX 1400 TITANIO LEFT UPPER PART (FLIGHT POSITION) 1400 TITANIUM TINOX FRAME PARTIE SUPÉRIEURE GAUCHE (POSITION DE VOL) CHÂSSIS TINOX 1400 TITANE	287,50 €
	TG03	PARTE SUPERIOR IZQUIERDA (POSICIÓN DE VUELO) CHASIS TINOX 1500 TITANIO LEFT UPPER PART (FLIGHT POSITION) 1500 TITANIUM TINOX FRAME PARTIE SUPÉRIEURE GAUCHE (POSITION DE VOL) CHÂSSIS TINOX 1500 TITANE	317,50 €
	T04	PARTE SUPERIOR DERECHA (POSICIÓN DE VUELO) CHASIS TINOX 1400 TITANIO RIGHT UPPER PART (FLIGHT POSITION) 1400 TITANIUM TINOX FRAME PARTIE SUPÉRIEURE DROITE (POSITION DE VOL) CHÂSSIS TINOX 1400 TITANE	287,50 €
	TG04	PARTE SUPERIOR DERECHA (POSICIÓN DE VUELO) CHASIS TINOX 1500 TITANIO RIGHT UPPER PART (FLIGHT POSITION) 1500 TITANIUM TINOX FRAME PARTIE SUPÉRIEURE DROITE (POSITION DE VOL) CHÂSSIS TINOX 1500 TITANE	317,50 €
	T05	PARTE INFERIOR DERECHA (POSICIÓN DE VUELO) CHASIS TINOX 1400 TITANIO RIGHT LOWER PART (FLIGHT POSITION) 1400 TITANIUM TINOX FRAME PARTIE INFÉRIEURE DROITE (POSITION DE VOL) CHÂSSIS TINOX 1400 TITANE	187,50 €
	TG05	PARTE INFERIOR DERECHA (POSICIÓN DE VUELO) CHASIS TINOX 1500 TITANIO RIGHT LOWER PART (FLIGHT POSITION) 1500 TITANIUM TINOX FRAME PARTIE INFÉRIEURE DROITE (POSITION DE VOL) CHÂSSIS TINOX 1500 TITANE	207,50 €

TINOX

ACERO INOX · STAINLESS STEEL · ACIER INOXIDABLE









	TA-MS	CHASIS TINOX 1400 ACERO INOX (MOSTER, SAFARI, ATOM Y PA125) COMPLETE TINOX 1400 STAINLESS STEEL FRAME (MOSTER, SAFARI, ATOM & PA125) CHASSIS TINOX 1400 ACIER INOXIDABLE (MOSTER, SAFARI, ATOM ET PA125)	1.187,50 €
	TA-P	CHASIS TINOX 1400 ACERO INOX (POLINI) COMPLETE TINOX 1400 STAINLESS STEEL FRAME (POLINI) CHASSIS TINOX 1400 ACIER INOXIDABLE (POLINI)	1.250,00 €
	TAG-MS	CHASIS TINOX 1500 ACERO INOX (MOSTER, SAFARI, ATOM Y PA125) COMPLETE TINOX 1500 STAINLESS STEEL FRAME (MOSTER, SAFARI, ATOM & PA125) CHASSIS TINOX 1500 ACIER INOXIDABLE (MOSTER, SAFARI, ATOM ET PA125)	1.312,50 €
	TAG-P	CHASIS TINOX 1500 ACERO INOX (POLINI) COMPLETE TINOX 1500 STAINLESS STEEL FRAME (POLINI) CHASSIS TINOX 1500 ACIER INOXIDABLE (POLINI)	1.375,00 €
	T01	PIE CHASIS 1400 TINOX MAIN PART TINOX FRAME 1400 BASE DE CHÂSSIS 1400 TINOX	325,00 €
	T01G	PIE CHASIS 1500 TINOX MAIN PART TINOX FRAME 1500 BASE DE CHÂSSIS 1500 TINOX	325,00 €

	TA02	PARTE INFERIOR IZQUIERDA (POSICIÓN DE VUELO) CHASIS TINOX 1400 ACERO INOX LEFT LOWER PART (FLIGHT POSITION) 1400 STAINLESS STEEL TINOX FRAME PARTIE INFÉRIEURE GAUCHE (POSITION DE VOL) CHÂSSIS TINOX 1400 ACIER INOXIDABLE	162,50 €
	TAG02	PARTE INFERIOR IZQUIERDA (POSICIÓN DE VUELO) CHASIS TINOX 1500 ACERO INOX LEFT LOWER PART (FLIGHT POSITION) 1500 STAINLESS STEEL TINOX FRAME PARTIE INFÉRIEURE GAUCHE (POSITION DE VOL) CHÂSSIS TINOX 1500 ACIER INOXIDABLE	187,50 €
	TA03	PARTE SUPERIOR IZQUIERDA (POSICIÓN DE VUELO) CHASIS TINOX 1400 ACERO INOX LEFT UPPER PART (FLIGHT POSITION) 1400 STAINLESS STEEL TINOX FRAME PARTIE SUPÉRIEURE GAUCHE (POSITION DE VOL) CHÂSSIS TINOX 1400 ACIER INOXIDABLE	250,50 €
	TAG03	PARTE SUPERIOR IZQUIERDA (POSICIÓN DE VUELO) CHASIS TINOX 1500 ACERO INOX LEFT UPPER PART (FLIGHT POSITION) 1500 STAINLESS STEEL TINOX FRAME PARTIE SUPÉRIEURE GAUCHE (POSITION DE VOL) CHÂSSIS TINOX 1500 ACIER INOXIDABLE	287,50 €
	TA04	PARTE SUPERIOR DERECHA (POSICIÓN DE VUELO) CHASIS TINOX 1400 ACERO INOX RIGHT UPPER PART (FLIGHT POSITION) 1400 STAINLESS STEEL TINOX FRAME PARTIE SUPÉRIEURE DROITE (POSITION DE VOL) CHÂSSIS TINOX 1400 ACIER INOXIDABLE	250,50 €
	TAG04	PARTE SUPERIOR DERECHA (POSICIÓN DE VUELO) CHASIS TINOX 1500 ACERO INOX RIGHT UPPER PART (FLIGHT POSITION) 1500 STAINLESS STEEL TINOX FRAME PARTIE SUPÉRIEURE DROITE (POSITION DE VOL) CHÂSSIS TINOX 1500 ACIER INOXIDABLE	287,50 €
	TA05	PARTE INFERIOR DERECHA (POSICIÓN DE VUELO) CHASIS TINOX 1400 ACERO INOX RIGHT LOWER PART (FLIGHT POSITION) 1400 STAINLESS STEEL TINOX FRAME PARTIE INFÉRIEURE DROITE (POSITION DE VOL) CHÂSSIS TINOX 1400 ACIER INOXIDABLE	162,50 €
	TAG05	PARTE INFERIOR DERECHA (POSICIÓN DE VUELO) CHASIS TINOX 1500 ACERO INOX RIGHT LOWER PART (FLIGHT POSITION) 1500 STAINLESS STEEL TINOX FRAME PARTIE INFÉRIEURE DROITE (POSITION DE VOL) CHÂSSIS TINOX 1500 ACIER INOXIDABLE	187,50 €

ELEMENTOS GENERALES
GENERAL ELEMENTS
ELEMENTS GENERAUX
MOSQUETONES
AUTOLOCK SHACKLES
MOUSQUETONS

PVP

	A33	MOSQUETON PARAPENTE ZICRAL ZICRAL AUTOLOCK CARABINE FOR PARAGLIDING MOUSQUETON PARAPENTE ZICRAL	18,00 €
	A33A	MOSQUETON PARAFLY ACERO STAINLESS STEEL AUTOLOCK CARABINE PARAFLY MOUSQUETON PARAFLY ACIER	20,00 €
	A34	MOSQUETON PARACAÍDAS Ø 6 mm. AUTOLOCK CARABINE FOR PARACHUTE Ø 6 mm. MAILLON PARACHUTE Ø 6 mm.	12,00 €
	A34A	MOSQUETON PARACAÍDAS Ø 7 mm. AUTOLOCK CARABINE FOR PARACHUTE Ø 7 mm. MAILLON PARACHUTE Ø 7 mm.	15,00 €
	A29	GRILLETE 6 mm. SHACKLE 6 mm. MANILLE 6 mm.	3,80 €
	A30	GRILLETE 4 mm. SHACKLE 4 mm. MANILLE 4 mm.	2,50 €
	A79	HEBILLA PICCOLO 20 mm. PICCOLO BUCKLE 20 mm. BOUCLE PICCOLO 20 mm.	6,50 €





ELEMENTOS GENERALES
GENERAL ELEMENTS
ELEMENTS GENERAUX
BRAZO
A.S.ARMS
BRAS

PVP

	A04ALK	BRAZOS ALUMINIO CON KIT FIJACIÓN (2 uds.) GIRO DE HELICE A LA DERECHA (posición de vuelo) ALUMINIUM ARMS WITH FIXING KIT (2 units) PROPELLER TURN RIGHT (fly position) BRAS ALUMINIUM AVEC KIT FIXATION (2 unités) HELICE TOUR DROITE (position de vol)	125,00 €
	A04ALKI	BRAZOS ALUMINIO CON KIT FIJACIÓN (2 uds.) GIRO DE HELICE A LA IZQUIERDA (posición de vuelo) ALUMINIUM ARMS WITH FIXING KIT (2 units) PROPELLER TURN LEFT (fly position) BRAS ALUMINIUM AVEC KIT FIXATION (2 unités) HELICE TOUR GAUCHE (position de vol)	125,00 €
	A04K	KIT FIJACIÓN BRAZO (1 ud.) ARM FIXING KIT (1 unit) KIT FIXATION BRAS ALUMINIUM (1 unité)	8,00 €
	A04K2	KIT FIJACIÓN BRAZO (1 ud.) ARM FIXING KIT (1 unit) KIT FIXATION BRAS ALUMINIUM (1 unité)	8,00 €
	A04K3	KIT FIJACIÓN BRAZO (1 ud.) ARM FIXING KIT (1 unit) KIT FIXATION BRAS ALUMINIUM (1 unité)	8,00 €
	G22ATS	SISTEMA ATS (2 ud.) ATS SYSTEM (2 units) SYSTEME ATS (2 unités)	75,00 €
	T10D	Separador Brazo Tinox Derecho Separador Brazo Tinox Derecho Separador Brazo Tinox Derecho	14,50 €
	T10I	Separador Brazo Tinox Izquierdo Separador Brazo Tinox Izquierdo Separador Brazo Tinox Izquierdo	14,50 €

ELEMENTOS GENERALES
GENERAL ELEMENTS
ELEMENTS GENERAUX
ARRANQUE
STARTER
DÉMARREUR

PVP

	A24	CORREA para ARRANQUE DE PIE FOOT STARTER STRAP LANCEUR PIED	15,00 €
	A37	POLEA DE PIE ROLSTAN FOOT STARTER PULLEY ROLSTAN POULIE DE PIED ROLSTAN	23,00 €
	A66	ASA ARRANQUE MANUAL, TODOS LOS MODELOS HANDLE FOR MANUAL STARTER POIGNÉE DEMARERUR MANUEL, TOUS LES MODELES	7,20 €
	A84	ROLLO DE CUERDA DE ARRANQUE (100 METROS) MANUAL START ROPE (ROLL 100 METERS) ROULEAU CORDE DÉMARREUR (100 METRES)	77,31 €

















ELEMENTOS GENERALES
GENERAL ELEMENTS
ELEMENTS GENERAUX
ACEITE SINTÉTICO
SYNTHETIC OIL
HUILE SYNTHÉTIQUE

PVP

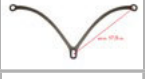
	ATTS	ACEITE SINTÉTICO CASTROL POWER 1 RACING 125 ml. (1 ud.) SYNTHETIC OIL CASTROL POWER 1 RACING 125 ml. (1 unit) HUILE SYNTHÉTIQUE CASTROL POWER 1 RACING 125 ml. (1 unité)	2,30 €
	ATTSC	ACEITE SINTÉTICO CASTROL POWER 1 RACING 125 ml. (48 uds. - 1,40 €/ud.) SYNTHETIC OIL CASTROL POWER 1 RACING 125 ml. (48 units - 1,40 €/unit) HUILE SYNTHÉTIQUE CASTROL POWER 1 RACING 125 ml. (48 unités - 1,40€/unités)	67,20 €
	121.200	TUBO MEDIDOR PARA ACEITE 100 gr. MEASURING OIL TUBE 100gr. MEASURING OIL TUBE 100 gr.	8,64 €

ELEMENTOS GENERALES
GENERAL ELEMENTS
ELEMENTS GENERAUX
DEPOSITO
FUEL TANK
RÉSERVOIR À ESSENCE
page
1/2

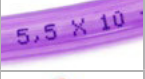
PVP

	A03PO	MINI BOMBA MANUAL POLINI POLINI MANUAL FUEL PUMP MINI MINI POLONI POIRE À ESSENCE MANUELLE	16,00 €
	A26A	DEPOSITO 13 LITROS (MODELO SIN SOPORTE, CON CRUCETA). TAPON INCLUIDO 13L. FUEL TANK (MODEL WITHOUT SUPPORT, WITH STABILIZER). CAP INCLUDED RÉSERVOIR 13 LITRES (MODELE SANS SUPPORT, AVEC RIGIDIFICATEUR). BOUCHON INCLUS	95,00 €
	A26AST	DEPOSITO 13 LITROS (MODELO SIN SOPORTE, CON CRUCETA). NO INCLUYE EL TAPON 13L. FUEL TANK (MODEL WITHOUT SUPPORT, WITH STABILIZER). CAP NOT INCLUDED RÉSERVOIR 13 LITRES (MODELE SANS SUPPORT, AVEC RIGIDIFICATEUR). SANS BOUCHON	92,00 €
	A26AKC	DEPOSITO 13 LITROS (MODELO SIN SOPORTE, CON CRUCETA). CRUCETA INCLUIDA 13L. FUEL TANK (MODEL WITHOUT SUPPORT, WITH STABILIZER). STABILIZER INCLUDED RÉSERVOIR 13 LITRES (MODELE SANS SUPPORT, AVEC RIGIDIFICATEUR). AVEC RIGIDIFICATEUR	111,53 €
	A26AKCST	DEPOSITO 13 LITROS (MODELO SIN SOPORTE, CON CRUCETA). CRUCETA INCLUIDA. NO INCLUYE EL TAPON 13L. FUEL TANK (MODEL WITHOUT SUPPORT, WITH STABILIZER). STABILIZER INCLUDED. CAP NOT INCLUDED RÉSERVOIR 13 LITRES (MODELE SANS SUPPORT, AVEC RIGIDIFICATEUR). AVEC RIGIDIFICATEUR. SANS BOUCHON	108,53 €
	A26AC	CRUCETA DEPÓSITO ALUMINIUM STABILIZER FOR THE FUEL TANK RIGIDIFICATEUR DU RÉSERVOIR À ESSENCE.	16,53 €
	A26A6K	KIT TORNILLOS Y CASQUILLOS ADAPTADOR MÉTRICA 6. SCREWS AND BUSHING KIT, ADAPTOR METRICS 6 KIT VIS ET DOUILLES ADAPTATEUR MÉTRIQUE 6	4,30 €
	A26CN	SOPORTE DEPOSITO (TOP80 / EVO100 / ROS125 / RM80 / PA125) FUEL TANK SUPPORT (TOP80 / EVO100 / ROS125 / RM80 / PA125) SUPPORT ARRIÈRE RÉSERVOIR (TOP80 / EVO100 / ROS125 / RM80 / PA125)	7,00 €
	A26M	SOPORTE DEPOSITO (RM80 / PA125 / MOSTER185) FUEL TANK SUPPORT (RM80 / PA125 / MOSTER185) SUPPORT ARRIÈRE RÉSERVOIR (RM80 / PA125 / MOSTER185)	9,50 €
	A26F	SOPORTE DEPOSITO (F200) FUEL TANK SUPPORT (F200) SUPPORT ARRIÈRE RÉSERVOIR (F200)	9,50 €
	A26TH	SOPORTE DEPOSITO (THOR80/130/190/200/250 CHASIS 1400/1450/1500) FUEL TANK SUPPORT (THOR80/130/190/200/250 CHASIS 1400/1450/1500) SUPPORT ARRIÈRE RÉSERVOIR (THOR80/130/190/200/250 CHASIS 1400/1450/1500)	7,00 €
	A26TP	SOPORTE DEPOSITO (THOR80/130/190/200/250 CHASIS 1250) FUEL TANK SUPPORT (THOR80/130/190/200/250 CHASIS 1250) SUPPORT ARRIÈRE RÉSERVOIR (THOR80/130/190/200/250 CHASIS 1250)	7,00 €
	A32	TUBO GASOLINA TYGON TRANSPARENTE (1 METRO) 3,2mm TYGON TRANSPARENT FUEL TUBE (1 METER) 3,2 mm TUBE À ESSENCE TRANSPARENT TYGON (1 METRE) 3,2 mm	7,30 €
	A32LA	TUBO GASOLINA ARIETE MORADO 4,8 X 9 (1 METRO) ARIETE PURPLE FUEL TUBE 4,8 X 9 (1 METER) TUBE À ESSENCE ARIETE MAUVE 4,8 X 9 (1 METRE)	7,00 €
	A32LA5	TUBO GASOLINA ARIETE MORADO 5,5 X 10 (1 METRO) ARIETE PURPLE FUEL TUBE 5,5 X 10 (1 METER) TUBE À ESSENCE ARIETE MAUVE 5,5 X 10 (1 METRE)	7,50 €
	A26GR	GRIFO CIRCUITO RESPIRADERO CUT OF TAP ROBINET CIRCUIT DE MISE À L'AIR	6,00 €

	A26T	TAPON DEPOSITO GASOLINA 13L 13L. FUEL TANK TAP BOUCHON RÉSERVOIR 13 L.	11,25 €
	A46	TUBO GASOLINA (1 METRO) 6 mm FUEL TUBE (1 METER) 6 mm TUBE À ESSENCE (1 METRE) 6 mm	9,00 €
	A46R	ROLLO TUBO GASOLINA (15 METROS) 6 mm FUEL TUBE ROLL (15 METERS) 6 mm ROULEAU TUBE À ESSENCE (15 METRES) 6 mm	135,00 €
	A46A	TUBO GASOLINA (1 METRO) 3,2 mm FUEL TUBE (1 METER) 3,2 mm TUBE À ESSENCE (1 METRE) 3,2 mm	9,00 €
	A46AR	ROLLO TUBO GASOLINA (15 METROS) 3,2 mm FUEL TUBE ROLL (15 METERS) 3,2 mm ROULEAU TUBE À ESSENCE (15 METRES) 3,2 mm	135,00 €
	A26A9	DEPOSITO 9 litros (RM80 Light) 9L. FUEL TANK (RM80 Light) RÉSERVOIR 9 litres (RM80 Light)	50,00 €
	A26A5	DEPOSITO 5 litros (RM80 Light) 5L. FUEL TANK (RM80 Light) RÉSERVOIR 5 litres (RM80 Light)	45,00 €
	A95	TUBO GASOLINA INTERIOR DEPOSITO (27cm) INSIDE FUEL TUBE (27cm) TUBE À ESSENCE INTÉRIEUR RÉSERVOIR (27cm)	2,50 €
	A95M	TUBO GASOLINA INTERIOR DEPOSITO, METRO INSIDE FUEL TUBE, METER TUBE À ESSENCE INTÉRIEUR RÉSERVOIR, METRE	7,50 €
	A96	RACCORD DEPOSITO FUEL TANK RACCORD RACCORD RÉSERVOIR	7,50 €
	A98	JUNTA TORICA RACCORD DEPOSITO FUEL TANK RACCORD GASKET JOINT TORIQUE RACCORD RÉSERVOIR	0,64 €
	A47	VALVULA BICICLETA VENT VALVE VALVE DE BICYCLETTE	2,50 €
	A26GM	GRIFO GASOLINA FUEL CUT OF TAP ROBINET À ESSENCE	10,60 €
	A189	FILTRO "POREX" INTERIOR DEPOSITO FUEL TANK INSIDE "POREX" FILTER FILTRE "POREX" RÉSERVOIR	5,14 €
	A190	RECAMBIO FILTRO "POREX" INTERIOR DEPOSITO SPARE FUEL TANK INSIDE "POREX" FILTER RECHANGE FILTRE "POREX" RÉSERVOIR	2,50 €
	A189KIT	KIT INTERIOR DEPOSITO POREX (A95 + A96 + A97 + A98 + A189) INSIDE FUEL TANK POREX KIT (A95 + A96 + A97 + A98 + A189) KIT PLONGEUR RÉSERVOIR POREX (A95 + A96 + A97 + A98 + A189)	17,10 €

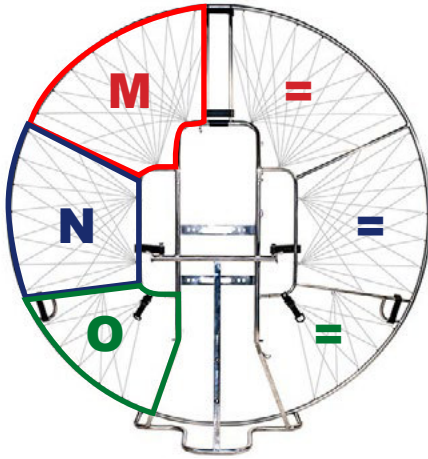



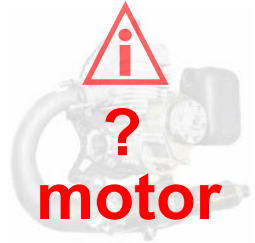



3 PARTES
3 PARTS
3 PARTIES



RN125MNO x2 M+N+O	RED RACING COMPLETA (3 partes Tamaño 1250mm) (incluye RNK50 / A58) COMPLET RACING NET (3 parts 1250mm Size) (RNK50 / A58 include) FILET RACING COMPLET (3 parties Diamètre 1250mm) (RNK50 / A58 inclue)	53,72 €
RN140MNO x2 M+N+O	RED RACING COMPLETA (3 partes Tamaño 1400mm) (incluye RNK50 / A58) COMPLET RACING NET (3 parts 1400mm Size) (RNK50 / A58 include) FILET RACING COMPLET (3 parties Diamètre 1400mm) (RNK50 / A58 inclue)	53,72 €
RN145MNO x2 M+N+O	RED RACING COMPLETA (3 partes Tamaño 1250mm) (incluye RNK50 / A58) COMPLET RACING NET (3 parts 1450mm Size) (RNK50 / A58 include) FILET RACING COMPLET (3 parties Diamètre 1450mm) (RNK50 / A58 inclue)	53,72 €
RN150MNO x2 M+N+O	RED RACING COMPLETA (3 partes Tamaño 1500mm) (incluye RNK50 / A58) COMPLET RACING NET (3 parts 1500mm Size) (RNK50 / A58 include) FILET RACING COMPLET (3 parties Diamètre 1500mm) (RNK50 / A58 inclue)	53,72 €
RN125M M	RED RACING SUPERIOR (3 partes Tamaño 1250mm) RACING NET UPPER PART (3 parts 1250mm Size) FILET RACING SUPERIEUR (3 parties Diamètre 1250mm)	10,75 €
RN140M M	RED RACING SUPERIOR (3 partes Tamaño 1400mm) RACING NET UPPER PART (3 parts 1400mm Size) FILET RACING SUPERIEUR (3 parties Diamètre 1400mm)	10,75 €
RN145M M	RED RACING SUPERIOR (3 partes Tamaño 1450mm) RACING NET UPPER PART (3 parts 1450mm Size) FILET RACING SUPERIEUR (3 parties Diamètre 1450mm)	10,75 €
RN150M M	RED RACING SUPERIOR (3 partes Tamaño 1500mm) RACING NET UPPER PART. (3 parts 1500mm Size) FILET RACING SUPERIEUR (3 parties Diamètre 1500mm)	10,75 €
RN125N N	RED RACING MEDIA (3 partes Tamaño 1250mm) RACING NET HALF (3 parts 1250mm Size) FILET RACING MOYENNE (3 parties Diamètre 1250mm)	10,75 €
RN140N N	RED RACING MEDIA (3 partes Tamaño 1400mm) RACING NET HALF (3 parts 1400mm Size) FILET RACING MOYENNE (3 parties Diamètre 1400mm)	10,75 €
RN145N N	RED RACING MEDIA (3 partes Tamaño 1450mm) RACING NET HALF (3 parts 1450mm Size) FILET RACING MOYENNE (3 parties Diamètre 1450mm)	10,75 €
RN150N N	RED RACING MEDIA (3 partes Tamaño 1500mm) RACING NET HALF (3 parts 1500mm Size) FILET RACING MOYENNE (3 parties Diamètre 1500mm)	10,75 €
RN125O O	RED RACING INFERIOR (3 partes Tamaño 1250mm) RACING NET LOWER (3 parts 1250mm Size) FILET RACING INFÉRIEUR (3 parties Diamètre 1250mm)	8,27 €
RN140O O	RED RACING INFERIOR (3 partes Tamaño 1400mm) RACING NET LOWER (3 parts 1400mm Size) FILET RACING INFÉRIEUR (3 parties Diamètre 1400mm)	8,27 €
RN145O O	RED RACING INFERIOR (3 partes Tamaño 1450mm) RACING NET LOWER (3 parts 1450mm Size) FILET RACING INFÉRIEUR (3 parties Diamètre 1450mm)	8,27 €
RN150O O	RED RACING INFERIOR (3 partes Tamaño 1500mm) RACING NET LOWER (3 parts 1500mm Size) FILET RACING INFÉRIEUR (3 parties Diamètre 1500mm)	8,27 €







	 <p>4 PARTES 4 PARTS 4 PARTIES</p>		 <p>5 PARTES 5 PARTS 5 PARTIES</p>
RN145PQR x2 P+Q+R	RED RACING COMPLETA (4 partes Tamaño 1450mm) (incluye RNK50 / A58) COMPLET RACING NET (4 parts 1450mm Size) (RNK50 / A58 include) FILET RACING COMPLET (4 parties Diamètre 1450mm) (RNK50 / A58 inclue)		53,72 €
RN150PQR x2 P+Q+R	RED RACING COMPLETA (4 partes Tamaño 1500mm) (incluye RNK50 / A58) COMPLET RACING NET (4 parts 1500mm Size) (RNK50 / A58 include) FILET RACING COMPLET (4 parties Diamètre 1500mm) (RNK50 / A58 inclue)		53,72 €
RN145P P	RED RACING SUPERIOR (4 partes Tamaño 1450mm) RACING NET UPPER PART. (4 parts 1450mm Size) FILET RACING SUPERIEUR (4 parties Diamètre 1450mm)		10,75 €
RN150P P	RED RACING SUPERIOR (4 partes Tamaño 1500mm) RACING NET UPPER PART. (4 parts 1500mm Size) FILET RACING SUPERIEUR (4 parties Diamètre 1500mm)		10,75 €
RN145Q Q	RED RACING MEDIA (4 partes Tamaño 1450mm) RACING NET HALF (4 parts 1450mm Size) FILET RACING MOYENNE (3 parties Diamètre 1450mm)		14,88 €
RN150Q Q	RED RACING MEDIA (4 partes Tamaño 1500mm) RACING NET HALF (4 parts 1500mm Size) FILET RACING MOYENNE (4 parties Diamètre 1500mm)		14,88 €
RN145R R	RED RACING INFERIOR (4 partes Tamaño 1450mm) RACING NET LOWER (4 parts 1450mm Size) FILET RACING INFÉRIEUR (4 parties Diamètre 1450mm)		8,27 €
RN150R R	RED RACING INFERIOR (4 partes Tamaño 1500mm) RACING NET LOWER (4 parts 1500mm Size) FILET RACING INFÉRIEUR (4 parties Diamètre 1500mm)		8,27 €
RN140MNO x2 G+H	RED RACING MEDIA (3 partes Tamaño 1250mm) RACING NET HALF (3 parts 1250mm Size) FILET RACING MOYENNE (3 parties Diamètre 1250mm)		53,72 €
RN145MNO x2 G+H	RED RACING MEDIA (3 partes Tamaño 1400mm) RACING NET HALF (3 parts 1400mm Size) FILET RACING MOYENNE (3 parties Diamètre 1400mm)		53,72 €
RN150MNO x2 G+H	RED RACING MEDIA (3 partes Tamaño 1450mm) RACING NET HALF (3 parts 1450mm Size) FILET RACING MOYENNE (3 parties Diamètre 1450mm)		53,72 €
RN140M G	RED RACING MEDIA (3 partes Tamaño 1500mm) RACING NET HALF (3 parts 1500mm Size) FILET RACING MOYENNE (3 parties Diamètre 1500mm)		14,88 €
RN145M G	RED RACING INFERIOR (3 partes Tamaño 1250mm) RACING NET LOWER (3 parts 1250mm Size) FILET RACING INFÉRIEUR (3 parties Diamètre 1250mm)		14,88 €
RN150M G	RED RACING INFERIOR (3 partes Tamaño 1400mm) RACING NET LOWER (3 parts 1400mm Size) FILET RACING INFÉRIEUR (3 parties Diamètre 1400mm)		14,88 €
RN1400 H	RED RACING INFERIOR (3 partes Tamaño 1450mm) RACING NET LOWER (3 parts 1450mm Size) FILET RACING INFÉRIEUR (3 parties Diamètre 1450mm)		14,88 €
RN1450 H	RED RACING INFERIOR (3 partes Tamaño 1500mm) RACING NET LOWER (3 parts 1500mm Size) FILET RACING INFÉRIEUR (3 parties Diamètre 1500mm)		14,88 €
RN1500 H	RED RACING INFERIOR (5 partes Tamaño 1500mm) RACING NET LOWER (5 parts 1500mm Size) FILET RACING INFÉRIEUR (5 parties Diamètre 1500mm)		14,88 €

	A72	SUSPENDE DYNEEMA RED DE PROTECCION COLOR GRIS CLARO (1 METRO) DYNEEMA PROTECTION LINE (1 METER) LIGHT GRAY COLOR LIGNE DE PROTECTION DYNEEMA COULEUR GRISE CLAIR (1 METRE)	0,70 €
	A72NO	SUSPENDE DYNEEMA RED DE PROTECCION COLOR GRIS OSCURO (1 METRO) DYNEEMA PROTECTION LINE (1 METER) DARK GRAY COLOR LIGNE DE PROTECTION DYNEEMA COULEUR GRISE ANTHRACITE (1 METRE)	0,70 €
	RNK10	Kit remaches + cordinos, red racing (Paquete 10) Rivets + fixing lines kit for racing net (10 units) Kit rivets + suspente de fixation pour filet racing (10 unités)	6,61 €
	RNK50	Kit remaches + cordinos, red racing (Paquete 50) Rivets + fixing lines kit for racing net (50 units) Kit rivets + suspente de fixation pour filet racing (50 unités)	26,45 €
	A58	CIERRE SEGURIDAD (CHASIS RACING Y TINOX) SOLDERESS NIPPLE (RACING & TINOX FRAME) COLLIER CABLE DE SECURITÉ (CHASSIS RACING ET TINOX)	0,50 €
	RNT1	TENSOR red INFERIOR Lower NET TENSOR TENSEUR FILET INFERIEUR	8,75 €
	A48	PRESILLAS CORTAS "Thomas&Betts" - 92 mm. - RED CHASIS SINGLE (Paquete 100) "Thomas&Betts" NET SINGLE FRAME SMALL WRAPS -92 mm - (100 units) PETITE BRIDES "Thomas&Betts" - 92mm - FILET DE PROTECTION CHASSIS SINGLE (100 unités)	12,50 €
	A48LG	PRESILLAS LARGAS "Thomas&Betts" - 140 mm. - RED CHASIS SINGLE (Paquete 100) "Thomas&Betts" NET SINGLE FRAME LARGE WRAPS - 140 mm - (100 units) LONGUES BRIDES "Thomas&Betts" - 140 mm - FILET DE PROTECTION CHASSIS SINGLE (100 unités)	18,75 €
	A49	KIT REMACHES + CORDINOS FIJACION RED CHASIS SINGLE (10 uds.) RIVETS + FIXING LINE FOR SINGLE FRAME NET (10 units) KIT RIVETS + SUSPENDE FIXATION FILET DE PROTECTION CHASSIS SINGLE (10 unités)	5,00 €
	A58C	CIERRE SEGURIDAD (Chasis Single) SOLDERESS NIPPLE (Single Frame) COLLIER CABLE DE SECURITÉ (Chassis Single)	0,63 €
	A58LT	TENSOR 1 METRO + 4 CIERRES SEGURIDAD (Chasis Single) 1 METER TENSOR LINE + 4 SOLDERESS NIPPLE (Single Frame) LIGNE DE TENSION 1 METRE + 4 COLLIER CABLE DE SECURITÉ (Chassis Single)	5,00 €
	A39	RED DE PROTECCIÓN GRIS , EL METRO GREY PROTECTION NET, METER FILET DE PROTECTION GRIS AU MÈTRE	15,00 €
	A39BK	RED DE PROTECCIÓN NEGRA , EL METRO BLACK PROTECTION NET, METER FILET DE PROTECTION NOIR AU MÈTRE	15,00 €
	A41	PRESILLAS BLANCAS - 186 mm. - RED CHASIS DOBLE ARO (Paquete 100) NET DOUBLE MODEL FRAME WHITE WRAPS - 186 mm - (100 units) BLANCHE BRIDES - 186 mm - FILET DE PROTECTION CHASSIS DOUBLE (100 unités)	12,00 €

	A01A	ACCELERADOR COMPLETO CHASIS RACING *indicar partes del chasis, modelo paramotor y piloto diestro o zurdo RACING FRAME COMPLET ACCELERATOR *indicate chassis parts, paramotor model & right or left-handed ACCELERATEUR COMPLET CHÂSSIS RACING *indiquer parties chassis, modele moteur et droitier / gaucher	95,00 €
	A01ATX	ACCELERADOR COMPLETO CHASIS TINOX *modelo paramotor y piloto diestro o zurdo TINOX FRAME COMPLET ACCELERATOR *paramotor model & right or left-handed ACCELERATEUR COMPLET CHÂSSIS TINOX *modele moteur et droitier / gaucher	95,00 €
	A09	PRISONIERO PARA CABLE DE GAS LOCKING SCREW FOR GAS CABLE PRISONNIER POUR CABLE DE GAS	1,50 €
	A10	CABLE DE GAS GAS CABLE CABLE DE GAS	2,00 €
	A80	ABRAZADERA PRESIÓN SUJECCIÓN FUNDA ACCELERADOR AL CHASIS HOLDING METAL BAND FOR OUTER ACCELERATOR COVER COLLIER POUR GAINÉ POIGNÉE DE GAZ	3,00 €
	A81	AJUSTE DEL ACCELERADOR 6 mm THROTTLE ADJUSTER 6 mm RÉGLAGE CABLE GAZ DE 6 mm	2,92 €





ACCESORIOS
ACCESSORIES
ACCESSOIRES
PARACAIDAS
PARACHUTE
PARACHUTE

PVP

	G02	CONTENEDOR PARACAIDAS FRONTAL SUP'AIR SUP'AIR FRONT CONTAINER POCHE PARACHUTE SUP'AIR VENTRALE	65,00 €
	G02EV	CONTENEDOR PARACAIDAS LATERAL SUP'AIR (SILLA SUPAIR EVO) SUP'AIR LATERAL CONTAINER (SUP'AIR EVO HARNESS) POCHE PARACHUTE LATÉRALE SUP'AIR (SELLETTE SUP'AIR EVO)	90,00 €
	G02EVT	CONTENEDOR PARACAIDAS LATERAL SUP'AIR (SILLA SUPAIR EVO) TANDEM SUP'AIR TANDEM LATERAL CONTAINER (SUP'AIR EVO HARNESS) POCHE PARACHUTE LATÉRALE SUP'AIR (SELLETTE SUP'AIR EVO) TANDEM	90,00 €
	G14	PARACAIDAS SUP' AIR SHINE. TALLA L (<125 Kg.) SUP' AIR SHINE PARACHUTE CANOPY. SIZE L (<125 Kg.) PARACHUTE DE SECOUR SUP' AIR SHINE. TAILLE L (<125 Kg.)	575,00 €
	G14T	PARACAIDAS SUP' AIR EXTRALIGHT TANDEM SUP' AIR EXTRALIGHT TANDEM PARACHUTE CANOPY PARACHUTE DE SECOUR SUP' AIR EXTRALIGHT TANDEM	1000,00 €
	G14N	PARACAIDAS NIVIUK OCTAGON 2 L NIVIUK OCTAGON 2 L PARACHUTE CANOPY PARACHUTE DE SECOUR NIVIUK OCTAGON 2 L	590,00 €
	G14NXL	PARACAIDAS NIVIUK OCTAGON 2 XL NIVIUK OCTAGON 2 XL PARACHUTE CANOPY PARACHUTE DE SECOUR NIVIUK OCTAGON 2 XL	628,00 €
	G14Y	CINTA PARACAIDAS EN Y Y CANOPY BELT SANGLE PARACHUTE EN Y	31,00 €
	G14YT	CINTA PARACAIDAS TANDEM EN Y TANDEM Y CANOPY BELT SANGLE PARACHUTE TANDEM EN Y	36,00 €
	A34	MOSQUETON PARACAÍDAS AUTOLOCK CARABINE FOR PARACHUTE MAILLON PARACHUTE	12,00 €





ACCESORIOS
ACCESSORIES
ACCESSOIRES
CHALECO SALVAVIDAS
LIFE JACKET
GILET DE SAUVETAGE







PVP







	G30	CHALECO SALVAVIDAS AUTOMATICO AUTOMATIC LIFE JACKET GILET DE SAUVETAGE AUTOMATIQUE	100,00 €
	G30R	KIT RECARGA CHALECO SALVAVIDAS AUTOMATIC LIFE JACKET RE-ARMING KIT KIT DE RECHARGE GILET DE SAUVETAGE AUTOMATIQUE	25,00 €
	GP31	CHALECO SALVAVIDAS PARAMOTOR AUTOMATICO PARAMOTOR AUTOMATIC LIFE JACKET GILET DE SAUVETAGE PARAMOTEUR AUTOMATIQUE	223,00 €
	GP31R	KIT RECARGA CHALECO PARAMOTOR PARAMOTOR LIFE JACKET RE-ARMING KIT KIT DE RECHARGE GILET DE SAUVETAGE PARAMOTEUR	54,69 €

ACCESORIOS
ACCESSORIES
ACCESSOIRES
TACÓMETRO/SENSOR
TACHOMETER/SENSOR
COMPTE-TOUR/THERMOMÈTRE

PVP

	G03	TACOMETRO / CUENTAHORAS DIGITAL DIGITAL TACHOMETER & HOURMETER COMPTE-TOURS DIGITAL	61,60 €
	G03TC	SENSOR DE TEMPERATURA PARA LA CULATA HEAD CYLINDER TEMPERATURE SENSOR THERMOMÈTRE DIGITAL CULASSE	68,50 €
	G03TR	SENSOR DE TEMPERATURA RADIADOR DE AGUA WATER RADIATOR TEMPERATURE SENSOR THERMOMÈTRE DIGITAL RADIATEUR EAU	68,50 €
	928.830.002	TACOMETRO/ORAS DIGITAL + SENSOR CHT DIGITAL RPM-HOURMETER + CHT SENSOR COMPTE-TOURS DIGITAL AVEC THERMOCOUPLE BOUGIE ET COMPTE	171,44 €

	G18	SEPARADOR BIPLAZA PARAMOTOR PAP PARAENGINE TANDEM SEPARATOR SEPARATEUR PAP TANDEM	125,00 €
	G20	KIT SISTEMA BIPLAZA (G17 + G18 + G20A + A33 + A33A + G20K) TANDEM KIT COMPANY SYSTEM (G17 + G18 + G20A + A33 + A33A + G20K) KIT TANDEM POUR COMPANY SYSTEME (G17 + G18 + G20A + A33 + A33A + G20K)	645,00 €
	G20A	ROLL BAR SISTEMA BIPLAZA ROLL BAR COMPANY SYSTEM ROLL BAR POUR COMPANY SYSTEME	70,00 €
	G20K	KIT DE FIJACIÓN ROLL BAR ROLL BAR FIXING KIT KIT DE FIXATION ROLL BAR	30,00 €
	TK029	DOBLE ARO TRIKE (CHASIS 1500 MOTOR THOR250). No incluye TK002/16. Trike double ring (1500 FRAME THOR250 MOTOR). TK002/16 not included. Double cerceau Trike (CHASSIS 1500 MOTEUR THOR250), non inclu TK002/16.	175,00 €
	TX029	DOBLE ARO TRIKE (CHASIS TINOX 1500). NO INCLUYE TK002/TX TRIKE DOBLE RING (1500 TINOX FRAME). TK002 NOT INCLUDED/tx DOUBLE CERCEAU TRIKE (CHASSIS 1500 TINOX), NON INCLU TK002/tx	200,00 €

	G15S	SILLA MONOPLAZA ESPECIAL PAP CON AIRBAG (Talla S, M , L, XL) SPECIAL PAP HARNESS WITH AIRBAG (S, M, L, XL Size) SELLETTE PILOTE PAP STANDARD AVEC AIRBAG (Taille S, M, L, XL)	462,81 €
	G17	SILLA PAP PASAJERO BIPLAZA CON AIRBAG PAP TANDEM PASSENGER HARNESS WITH AIRBAG SELLETTE PAP PASSAGER AVEC AIRBAG	360,00 €
	G14ATR	CINTA ANTIPAR REFORZADA REINFORCED ANTIPAR BELT SANGLE ANTI COUPLE RENFORCÉE	19,00 €
	G15TM	TABLA MADERA SILLA HARNESS WOOD BOARD PLATEAU BOIS POUR LA SELLETTE	25,00 €
	G15TC	TABLA CARBONO SILLA * NO APTA PARA PILOTAJE ACROBATICO * HARNESS CARBON BOARD * NOT SUITABLE FOR ACROBATICS FLIGHTS * PLATEAU CARBONE POUR LA SELLETTE * NE CONVIENT PAS POUR LES VOLS ACROBATIQUES *	58,00 €
	G15P	BOLSILLO DE LA SILLA PAP CON AIRBAG POCKET OF PAP HARNESS WITH AIRBAG POCHE DE LA SELLETTE PAP AVEC AIRBAG	60,00 €

	G11S	FUNDA DE TRANSPORTE MOTOR 3, 4 Y 5 PARTES (60cm x43cm x 97cm). ENGINE TRANSPORT BAG 3, 4 & 5 PARTS MODEL (60cm x43cm x 97cm). HOUSSE DE TRANSPORT MOTEUR 3, 4 ET 5 PARTIES (60cm x43cm x 97cm).	214,88 €
	G12	FUNDA DE TRANSPORTE CHASIS 3 PARTES. UNA PARTE DEL CHASIS. CAGE TRANSPORT BAG 3 PARTS MODEL. ONE FRAME PART. HOUSSE DE TRANSPORT CHASSIS 3 PARTIES. UNE PARTIE DE CHASSIS	33,06 €
	TK001	FUNDA TRIKE ROLLING ROLLING TRIKE LUGGAGE BAG HOUSSE DE TRANSPORT TRIKE ROLLING	180,00 €
	TK001M	FUNDA TRIKE MINI ROLLING MINI ROLLING TRIKE LUGGAGE BAG HOUSSE DE TRANSPORT TRIKE MINI ROLLING	180,00 €
	G010	FUNDA DE PARAMOTOR LIGERA PARAMOTOR LIGHT COVER HOUSSE DE PROTECTION PARAMOTEUR	79,34 €
	G13TX	FUNDA DE TRANSPORTE CHASIS TINOX 1400 TINOX CAGE TRANSPORT BAG 1400 HOUSSE DE TRANSPORT CHASSIS TINOX 1400	81,25 €
	G110TX	FUNDA DE TRANSPORTE CHASIS TINOX 1500 TINOX CAGE TRANSPORT BAG 1500 HOUSSE DE TRANSPORT CHASSIS TINOX 1500	87,50 €

PAP TRIKE

page
1/3

INCLUIDO DE SERIE
INCLUDED AS STANDARD
INCLU DE SÉRIE



TRIKE

+



TK001

+



TK002

PVP

P023

TRIKE ROLLING (x3 TK003)
ROLLING TRIKE (x3 TK003)
TRIKE ROLLING (x3 TK003)

1150,00 €

P023A

TRIKE ROLLING (x2 TK014 + x1 TK003)
ROLLING TRIKE (x2 TK014 + x1 TK003)
TRIKE ROLLING (x2 TK014 + x1 TK003)

1200,00 €

P023F

TRIKE ROLLING (x3 TK015)
ROLLING TRIKE (x3 TK015)
TRIKE ROLLING (x3 TK015)

1200,00 €

PM023F

TRIKE MINI ROLLING (x3 TK015)
MINI ROLLING TRIKE (x3 TK015)
TRIKE ROLLING MINI (x3 TK015)

1125,00 €



KIT BIPLAZA TRIKE ROLLING
ROLLING TRIKE TANDEM KIT
KIT TANDEM ROLLING TRIKE

**P023****P023A****P023F****PM023F**

ROLLING TRIKE

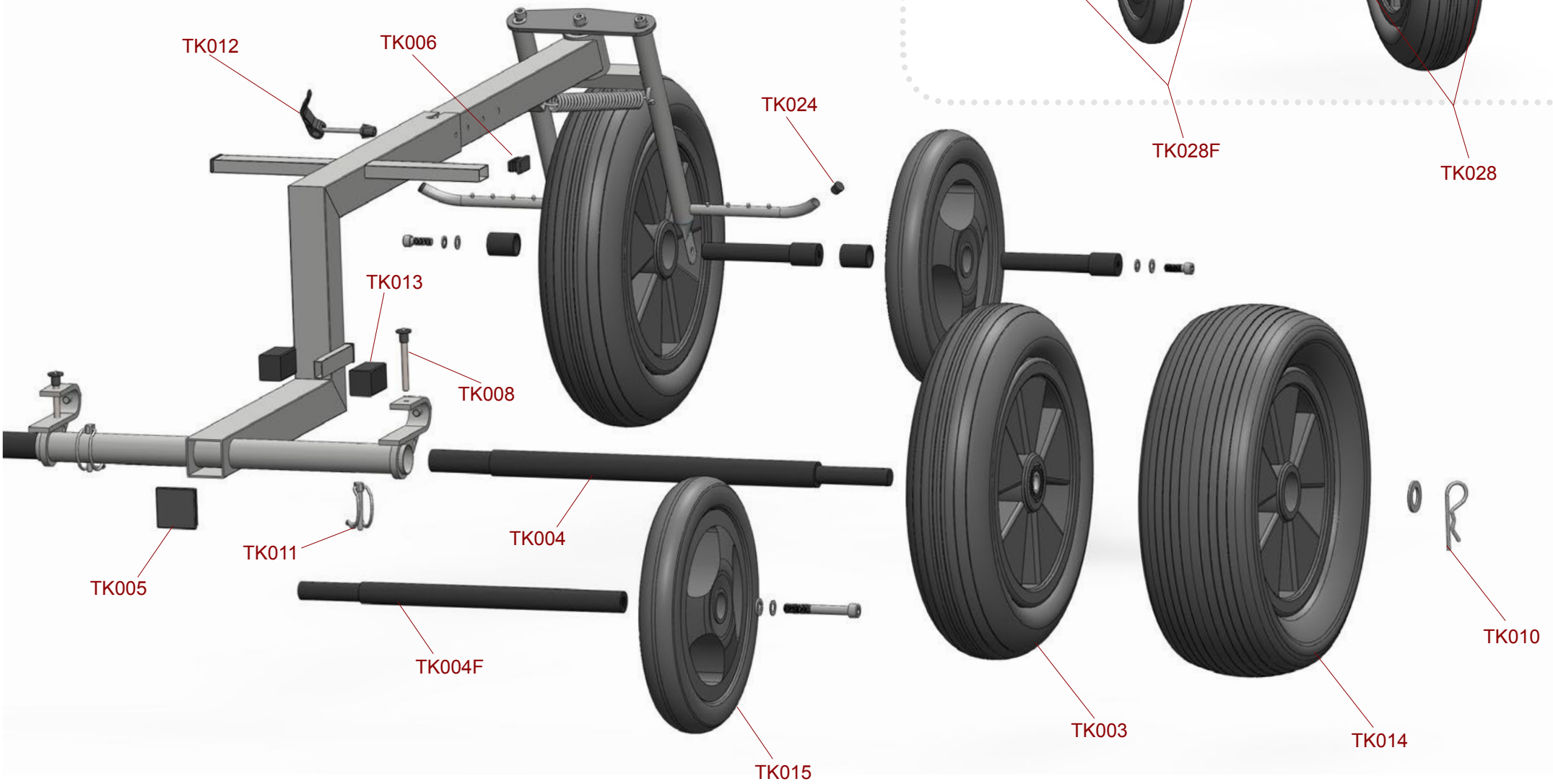

MINI ROLLING TRIKE

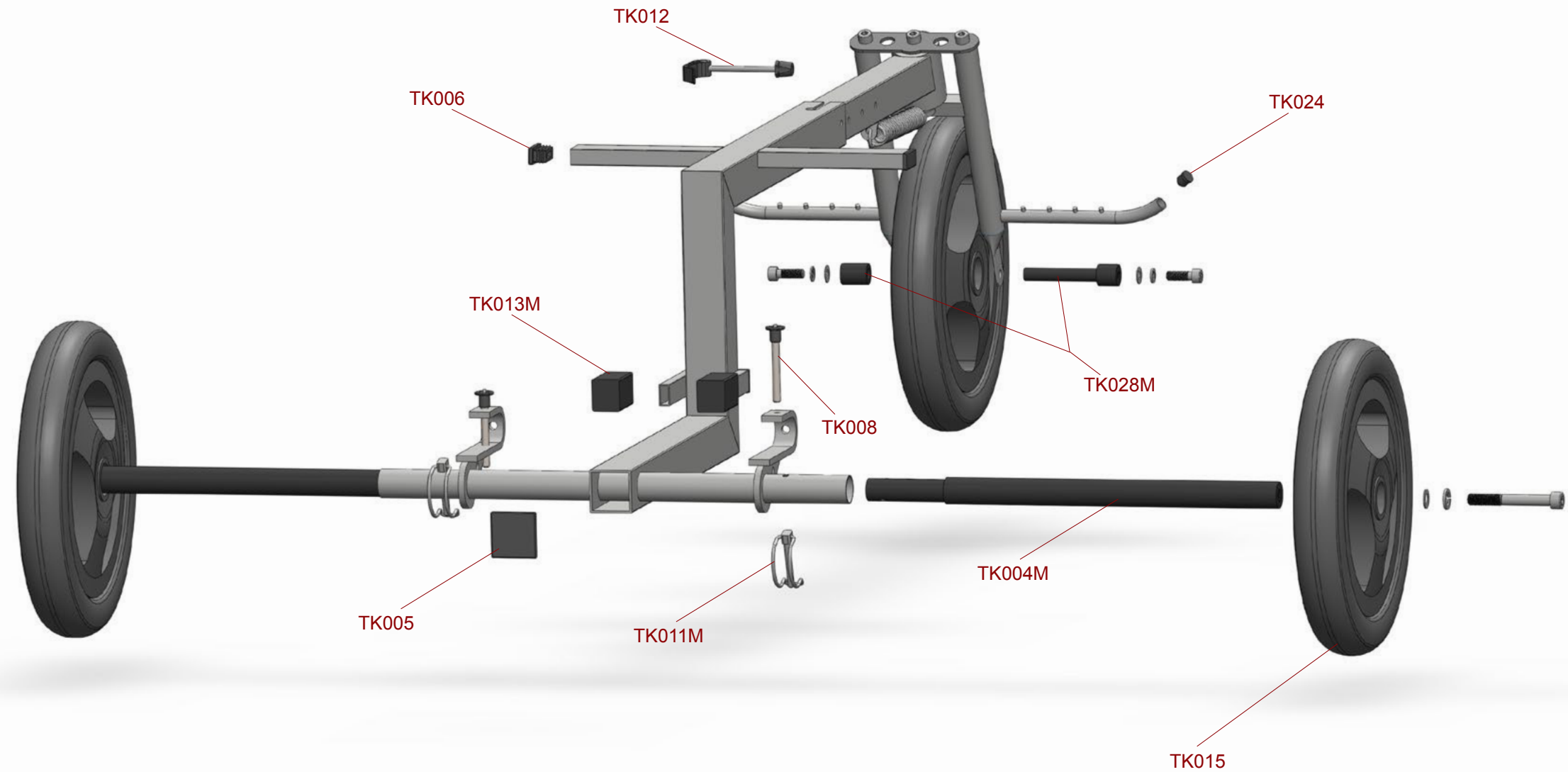

	TK001	FUNDA TRIKE ROLLING ROLLING TRIKE LUGGAGE BAG HOUSSE DE TRANSPORT TRIKE ROLLING	180,00 €
	TK001M	FUNDA TRIKE MINI ROLLING MINI ROLLING TRIKE LUGGAGE BAG HOUSSE DE TRANSPORT TRIKE MINI ROLLING	180,00 €
	TK002/16	CLIPS APOYO SU SPENTES PAP TRIKE (Grosor Aro Exterior Ø16) LINES SUPPORT CLIP PAPTRIKE (Thickness Outer Ring Ø16) CLIPS SOUTIEN SUSPENTES PAP TRIKE (Diamètre Cercle Extérieur Ø16)	35,00 €
	TK002/14	CLIPS APOYO SUSPENTES PAP TRIKE (Grosor Aro Exterior Ø14) LINES SUPPORT CLIP PAPTRIKE (Thickness Outer Ring Ø14) CLIPS SOUTIEN SUSPENTES PAP TRIKE (Diamètre Cercle Extérieur Ø14)	35,00 €
	TK002/ TX	CLIPS APOYO SU SPENTES PAP TRIKE (Grosor Aro Exterior TINOX) LINES SUPPORT CLIP PAPTRIKE (Thickness Outer Ring TINOX) CLIPS SOUTIEN SUSPENTES PAP TRIKE (Diamètre Cercle Extérieur TINOX)	35,00 €
	TK003	RUEDA ESTÁNDAR (4.80 / 4.00 - 8) PAP TRIKE 3,00 Kg. (10 cm. ancho x 40 diámetro) STANDARD PAPTRIKE WHEEL (4.80 / 4.00 - 8) 3,00 Kg. (10 cm. width x 40 diameter) ROUE STANDARD (4.80 / 4.00 - 8) PAP TRIKE 3,00 Kg. (10 cm. large x 40 diamètre)	39,00 €
	TK014	RUEDA ANCHA (16X 6,50 - 8) PAP TRIKE 3,60 Kg. (15 cm. ancho x 40 diámetro) WIDE PAPTRIKE WHEEL (16X 6,50 - 8) 3,60 Kg. (15 cm. width x 40 diameter) ROUE LARGE (16X 6,50 - 8) PAP TRIKE 3,60 Kg. (15 cm. large x 40 diamètre)	69,45 €
	TK015	RUEDA FINA (300 X 8) PAP TRIKE 1,05 Kg. (5 cm. ancho x 31 diámetro) NARROW PAPTRIKE WHEEL (300 X 8) 1,05 Kg. (5 cm. width x 31 diameter) ROUE ÉTROIT (300 X 8) PAP TRIKE 1,05 Kg. (5 cm. large x 31 diamètre)	54,45 €
	TK004	EJE ALUMINIO 7075 RUEDAS TRIKE ROLLING ROLLING TRIKE ALUMINIUM 7075 WHEEL AXLE AXE ALUMINIUM 7075 ROUES TRIKE ROLLING	100,00 €
	TK004F	EJE ALUMINIO 7075 RUEDAS FINAS (TK015) TRIKE ROLLING ROLLING TRIKE ALUMINIUM 7075 NARROW WHEEL (TK015) AXLE AXE ALUMINIUM 7075 ROUES ÉTROIT (TK015) TRIKE ROLLING	100,00 €
	TK004M	EJE ALUMINIO 7075 RUEDAS TRIKE MINI ROLLING MINI ROLLING TRIKE ALUMINIUM 7075 WHEEL AXLE AXE ALUMINIUM 7075 ROUES TRIKE MINI ROLLING	100,00 €
	TK005	TAPON 45X45 PAP TRIKE PAPTRIKE CAP 45X45 BOUCHON 45X45 PAP TRIKE	2,00 €
	TK006	TAPON 30X15 PAP TRIKE PAPTRIKE CAP 30X15 BOUCHON 30X15 PAP TRIKE	1,25 €
	TK007	TAPON 20X10 PAP TRIKE PAPTRIKE CAP 20X10 BOUCHON 20X10 PAP TRIKE	1,25 €
	TK008	PUSH PIN PAP TRIKE PAPTRIKE PUSH PIN PUSH PIN PAP TRIKE	17,40 €
	TK009	CABLE PUSH PIN PAP TRIKE PAPTRIKE PUSH PIN CABLE PUSH PIN CÂBLE PAP TRIKE	3,75 €
	TK010	CLIP RUEDA TRIKE ROLLING ROLLING TRIKE WHEEL CLIP CLIP ROUE TRIKE ROLLING	1,75 €
	TK011	CLIP M6X45 TUBOS TRIKE ROLLING ROLLING TRIKE M6X45 TUBES CLIP CLIP TUBES M6X45 TRIKE ROLLING	3,75 €
	TK011M	CLIP M6X45 TUBOS TRIKE MINI ROLLING MINI ROLLING TRIKE M6X45 TUBES CLIP CLIP TUBES M6X45 TRIKE MINI ROLLING	3,75 €
	TK012	CIERRE RAPIDO PALANCA PAP TRIKE PAPTRIKE QUICK CLOSING FERMETURE RAPIDE PAP TRIKE	10,00 €
	TK013	TAPON NYLON APOYO CHASIS TRIKE ROLLING ROLLING TRIKE SUPPORT NYLON CAP FOR THE CHASSIS BOUCHON NYLON SUPPORT CHASSIS TRIKE ROLLING	15,00 €

PAP

TRIKE

RECAMBIOS TRIKE
TRIKE SPARE PARTS
PIÈCES DE RECHANGE TRIKE

page
3/3

PVP

	TK013M	TAPON NYLON APOYO CHASIS TRIKE MINI ROLLING MINI ROLLING TRIKE SUPPORT NYLON CAP FOR THE CHASSIS BOUCHON NYLON SUPPORT CHASSIS TRIKE MINI ROLLING	15,00 €
	TK024	TAPON TUBO 16 PAPTRIKE TUBE 16 CAP PAPTRIKE BOUCHON TUBE 16 PAPTRIKE	2,00 €
	TK028	EJE RUEDA ESTÁNDAR DELANTERA TRIKE ROLLING ROLLING TRIKE FRONT STANDARD WHEEL AXLE AXE ROUE STANDARD AVANT TRIKE ROLLING	45,45 €
	TK028F	EJE RUEDA FINA (TK015) DELANTERA TRIKE ROLLING ROLLING TRIKE FRONT NARROW WHEEL (TK015) AXLE AXE ROUE ÉTROIT (TK015) AVANT TRIKE ROLLING	45,45 €
	TK028M	EJE RUEDA DELANTERA TRIKE MINI ROLLING MINI ROLLING TRIKE FRONT WHEEL AXLE AXE ROUE AVANT TRIKE MINI ROLLING	45,45 €

















TRIKE

KIT BIPLAZA
TANDEM KIT
KIT TANDEM

page
3/3

PVP

	TK025	KIT BIPLAZA TRIKE ROLLING (G17+G18+TK026+A33+A33A+TK027) ROLLING TRIKE TANDEM KIT (G17+G18+TK026+A33+A33A+TK027) KIT TANDEM TRIKE ROLLING (G17+G18+TK026+A33+A33A+TK027)	780,00 €
	G17	SILLA PAP PASAJERO BIPLAZA CON AIRBAG PAP TANDEM PASSENGER HARNESS WITH AIRBAG SELLETTE PAP PASSAGER AVEC AIRBAG	360,00 €
	G18	SEPARADOR BIPLAZA PARAMOTOR PAP PARAENGINE TANDEM SEPARATOR SEPARATEUR PAP TANDEM	125,00 €
	TK026	ASIENTO COPILOTO TRIKE PASSENGER TRIKE SEAT SIÈGE PASSAGER TRIKE	331,49 €
	G20K	KIT DE FIJACIÓN ROLL BAR ROLL BAR FIXING KIT KIT DE FIXATION ROLL BAR	30,00 €
	TK027	CINTA ESTABILIZADORA KIT TANDEM TRIKE ROLLING STABILIZER BELT TRIKE ROLLING KIT TANDEM SANGLE STABILISATRICE POUR LE KIT TANDEM DU TRIKE ROLLING	21,49 €
	A33	MOSQUETON PARAPENTE ZICRAL ZICRAL AUTOLOCK CARABINE FOR PARAGLIDING MOUSQUETON PARAPENTE ZICRAL	18,00 €
	A33A	MOSQUETON PARAFLY ACERO STAINLESS STEEL AUTOLOCK CARABINE PARAFLY MOUSQUETON PARAFLY ACIER	21,00 €
	TK029	DOBLE ARO TRIKE (CHASIS 1500 MOTOR THOR250). No incluye TK002/16. Trike double ring (1500 FRAME THOR250 MOTOR). TK002/16 not included. Double cerceau Trike (CHASSIS 1500 MOTEUR THOR250). non inclu TK002/16.	160,00 €
	TX029	DOBLE ARO TRIKE (CHASIS TINOX 1500). NO INCLUYE TK002/TX TRIKE DOBLE RING (1500 TINOX FRAME). TK002 NOT INCLUDED/tx DOUBLE CERCEAU TRIKE (CHASSIS 1500 TINOX). NON INCLU TK002/tx	200,00 €

	PA28	LINK 2 - Perfil Clásico (Tallas: 23 - 25 - 27 - 29)	* €
	PA29	KOUGAR 2 - Sport Réflex (Tallas: 20 - 23 - 25 - 28)	* €
	PA30	DOBERMAN - Pilonas (Tallas: 15 - 16 - 17 - 18)	* €
	PA44	QUBIK	* €

NIVIUK



Only sale in Spain

Vente uniquement en Espagne

*** Por favor, póngase en contacto para consultarnos el precio.**
Please, contact us to ask for the price.
S'il vous plaît, contactez-nous pour demander le prix.





















HELICES
PROPELLERS
HELICES

page
1/5

PVP

	G07	PROTECTORES HELICE 125 cm. (2 Unidades) PROPELLER 125 cm. COVERS (2 Unities) HOUSSE HELICE 125 cm. (2 Unitées)		38,00 €
	G07G	PROTECTORES HELICE 130 cm. (2 Unidades) PROPELLER 130 cm. COVERS (2 Unities) HOUSSE HELICE 130 cm. (2 Unitées)		38,00 €
	G07GG	PROTECTORES HELICE 140 cm. (2 Unidades) PROPELLER 140 cm. COVERS (2 Unities) HOUSSE HELICE 140 cm. (2 Unitées)		38,00 €
	H6440	KIT TORNILLOS HELICE M6 X 40mm. 4 Unidades KIT SCREW M6 X 40 mm. PROPELLER. 4 Unities KIT VIS HELICE M6 X 40 mm. 4 Unitées	M6 X 40 mm.	2,00 €
	H6640	KIT TORNILLOS HELICE M6 X 40mm. 6 Unidades KIT SCREW M6 X 40 mm. PROPELLER. 6 Unities KIT VIS HELICE M6 X 40 mm. 6 Unitées	M6 X 40 mm.	3,00 €
	H6450	KIT TORNILLOS HELICE M6 X 50mm. 4 Unidades KIT SCREW M6 X 50 mm. PROPELLER. 4 Unities KIT VIS HELICE M6 X 50 mm. 4 Unitées	M6 X 50 mm.	2,00 €
	H6650	KIT TORNILLOS HELICE M6 X 50mm. 6 Unidades KIT SCREW M6 X 50 mm. PROPELLER. 6 Unities KIT VIS HELICE M6 X 50 mm. 6 Unitées	M6 X 50 mm.	3,00 €
	H6460	KIT TORNILLOS HELICE M6 X 60mm. 4 Unidades KIT SCREW M6 X 60 mm. PROPELLER. 4 Unities KIT VIS HELICE M6 X 60 mm. 4 Unitées	M6 X 60 mm.	2,00 €
	H6660	KIT TORNILLOS HELICE M6 X 60mm. 6 Unidades KIT SCREW M6 X 60 mm. PROPELLER. 6 Unities KIT VIS HELICE M6 X 60 mm. 6 Unitées	M6 X 60 mm.	3,00 €
	H38	BIPALA Madera 108 cm. (RM80 LIGHT) WOOD 2-BLADE PROP. 108 cm. (RM80 LIGHT) BIPALE Bois 108 cm. (RM80 LIGHT)	RM80 LIGHT	193,75 €
	H39	BIPALA Carbono 110 cm. HELIX (RM80 LIGHT) CARBON 2-BLADE HELIX PROP. 110 cm. (RM80 LIGHT) BIPALE Carbone 110 cm. HELIX (RM80 LIGHT)	RM80 LIGHT	265,00 €

	H30	BIPALA Madera 115 cm. (RM80) WOOD 2-BLADE PROP. 115 cm. (RM80) BIPALE Bois 115 cm. (RM80)	RM80	193,75 €
	H31	BIPALA Carbono 115 cm. HELIX (RM80) CARBON 2-BLADE HELIX PROP. 115 cm. (RM80) BIPALE Carbone 115 cm. HELIX (RM80)	RM80	265,00 €
	H32	BIPALA Madera 125 cm. (RM80) WOOD 2-BLADE PROP. 125 cm. (RM80) BIPALE Bois 125 cm. (RM80)	RM80	193,75 €
	H33	BIPALA Carbono 125 cm. HELIX (RM80) CARBON 2-BLADE HELIX PROP. 125 cm. (RM80) BIPALE Carbone 125 cm. HELIX (RM80)	RM80	265,00 €
	H33S	BIPALA Carbono 130 cm. HELIX (RM80) CARBON 2-BLADE HELIX PROP. 130 cm. (RM80) BIPALE Carbone 130 cm. HELIX (RM80)	RM80	265,00 €
	H44	BIPALA Carbono 110 cm. HELIX (PA125 LIGHT) CARBON 2-BLADE HELIX PROP. 110 cm. (PA125 LIGHT) BIPALE Carbone 110 cm. HELIX (PA125 LIGHT)	PA125 LIGHT	265,00 €
	H34	BIPALA Madera 115 cm. (PA125) WOOD 2-BLADE PROP. 115 cm. (PA125) BIPALE Bois 115 cm. (PA125)	PA125	193,75 €
	H35	BIPALA Carbono 115 cm. HELIX (PA125) CARBON 2-BLADE HELIX PROP. 115 cm. (PA125) BIPALE Carbone 115 cm. HELIX (PA125)	PA125	265,00 €
	H36	BIPALA Madera 125 cm. (PA125) WOOD 2-BLADE PROP. 125 cm. (PA125) BIPALE Bois 125 cm. (PA125)	PA125	193,75 €
	H37	BIPALA Carbono 125 cm. HELIX (PA125) CARBON 2-BLADE HELIX PROP. 125 cm. (PA125) BIPALE Carbone 125 cm. HELIX (PA125)	PA125	265,00 €
	H37S	BIPALA Carbono 130 cm. HELIX (PA125) CARBON 2-BLADE HELIX PROP. 130 cm. (PA125) BIPALE Carbone 130 cm. HELIX (PA125)	PA125	265,00 €
	H200	BIPALA Carbono 125 cm. E-PROPS (PA125) CARBON 2-BLADE E-PROPS PROP. 125 cm. (PA125) BIPALE Carbone 125 cm. E-PROPS (PA125)	PA125	265,00 €
	H201	BIPALA Carbono 130 cm. E-PROPS (PA125) CARBON 2-BLADE E-PROPS PROP. 130 cm. (PA125) BIPALE Carbone 130 cm. E-PROPS (PA125)	PA125	265,00 €
	H53	BIPALA Carbono 115 cm. HELIX (MOSTER185) CARBON 2-BLADE HELIX PROP. 115 cm. (MOSTER185) BIPALE Carbone 115 cm. HELIX (MOSTER185)	MOSTER185	265,00 €
	H60	BIPALA Carbono 125 cm. HELIX (MOSTER185) CARBON 2-BLADE HELIX PROP. 125 cm. (MOSTER185) BIPALE Carbone 125 cm. HELIX (MOSTER185)	MOSTER185	265,00 €
	H42	BIPALA Carbono 130 cm. HELIX (MOSTER185) CARBON 2-BLADE HELIX PROP. 130 cm. (MOSTER185) BIPALE Carbone 130 cm. HELIX (MOSTER185)	MOSTER185	265,00 €
	H67	BIPALA Carbono 140 cm. HELIX (MOSTER185) CARBON 2-BLADE HELIX PROP. 140 cm. (MOSTER185) BIPALE Carbone 140 cm. HELIX (MOSTER185)	MOSTER185	300,00 €
	H62	BIPALA Carbono 115 cm. HELIX (THOR 130) CARBON 2-BLADE HELIX PROP. 115 cm. (THOR 130) BIPALE Carbone 115 cm. HELIX (THOR 130)	THOR130	265,00 €
	H51	BIPALA Carbono 125 cm. HELIX (THOR 130) CARBON 2-BLADE HELIX PROP. 125 cm. (THOR 130) BIPALE Carbone 125 cm. HELIX (THOR 130)	THOR130	265,00 €
	H54	BIPALA Madera 125 cm. (THOR 130) WOOD 2-BLADE PROP. (THOR 130) BIPALE Bois 125 cm. (THOR 130)	THOR130	193,75 €
	H52	BIPALA Carbono 130 cm. HELIX (THOR 130) CARBON 2-BLADE HELIX PROP. 130 cm. (THOR 130) BIPALE Carbone 130 cm. HELIX (THOR 130)	THOR130	265,00 €









	H220	BIPALA Carbono 125 cm. E-PROPS (THOR 130) CARBON 2-BLADE E-PROPS PROP. 125 cm. (THOR 130) BIPALE Carbone 125 cm. E-PROPS (THOR 130)	THOR130	265,00 €
	H221	BIPALA Carbono 130 cm. E-PROPS (THOR 130) CARBON 2-BLADE E-PROPS PROP. 130 cm. (THOR 130) BIPALE Carbone 130 cm. E-PROPS (THOR 130)	THOR130	265,00 €
	H56	BIPALA Carbono 125 cm. HELIX (THOR 190) CARBON 2-BLADE HELIX PROP. 125 cm. (THOR 190) BIPALE Carbone 125 cm. HELIX (THOR 190)	THOR190	265,00 €
	H57	BIPALA Carbono 130 cm. HELIX (THOR 190) CARBON 2-BLADE HELIX PROP. 130 cm. (THOR 190) BIPALE Carbone 130 cm. HELIX (THOR 190)	THOR190	265,00 €
	H45	TRIPALA Carbono 115 cm. HELIX (THOR 200) CARBON 3-BLADE HELIX PROP. 115 cm. (THOR 200) TRIPALE Carbone 115 cm. HELIX (THOR 200)	THOR200	381,25 €
	H46	BIPALA Carbono 125 cm. HELIX (THOR 200) CARBON 2-BLADE HELIX PROP. 125 cm. (THOR 200) BIPALE Carbone 125 cm. HELIX (THOR 200)	THOR200	265,00 €
	H49	BIPALA Carbono 130 cm. HELIX (THOR 200) CARBON 2-BLADE HELIX PROP. 130 cm. (THOR 200) BIPALE Carbone 130 cm. HELIX (THOR 200)	THOR200	265,00 €
	H230	BIPALA Carbono 125 cm. E-PROPS (THOR 200) CARBON 2-BLADE E-PROPS PROP. 125 cm. (THOR 200) BIPALE Carbone 125 cm. E-PROPS (THOR 200)	THOR200	265,00 €
	H231	BIPALA Carbono 130 cm. E-PROPS (THOR 200) CARBON 2-BLADE E-PROPS PROP. 130 cm. (THOR 200) BIPALE Carbone 130 cm. E-PROPS (THOR 200)	THOR200	265,00 €
	H58	BIPALA Carbono 130 cm. HELIX (THOR 250) CARBON 2-BLADE HELIX PROP. 130 cm. (THOR 250) BIPALE Carbone 130 cm. (THOR 250)	THOR250	375,00 €
	H59	TRIPALA Carbono 130 cm. HELIX (THOR 250) CARBON 3-BLADE HELIX PROP. 130 cm. (THOR 250) TRIPALE Carbone 130 cm. (THOR 250)	THOR250	562,50 €
	H65	BIPALA Carbono 140 cm. HELIX (THOR 250) CARBON 2-BLADE HELIX PROP. 140 cm. (THOR 250) BIPALE Carbone 140 cm. HELIX (THOR 250)	THOR250	400,00 €
	H240	BIPALA Carbono 125 cm. E-PROPS (THOR 250) CARBON 2-BLADE E-PROPS PROP. 125 cm. (THOR 250) BIPALE Carbone 125 cm. E-PROPS (THOR 250)	THOR250	265,00 €
	H241	BIPALA Carbono 130 cm. E-PROPS (THOR 250) CARBON 2-BLADE E-PROPS PROP. 130 cm. (THOR 250) BIPALE Carbone 130 cm. E-PROPS (THOR 250)	THOR250	265,00 €
	H242	BIPALA Carbono 140 cm. E-PROPS (THOR 250) CARBON 2-BLADE E-PROPS PROP. 140 cm. (THOR 250) BIPALE Carbone 140 cm. E-PROPS (THOR 250)	THOR250	357,00 €
	H243	BIPALA Carbono 145 cm. E-PROPS (THOR 250) CARBON 2-BLADE E-PROPS PROP. 145 cm. (THOR 250) BIPALE Carbone 145 cm. E-PROPS (THOR 250)	THOR250	357,00 €
	H06	BIPALA Madera 90 cm. Reduc: 3.38/1 (TOP) WOOD 2-BLADE PROP. 90 cm. Reduc: 3.38/1 (TOP) BIPALE Bois 90 cm. Reduc: 3.38/1 (TOP)	TOP80	193,75 €
	H07	BIPALA Madera 99 cm. Reduc: 3.38/1 (TOP) WOOD 2-BLADE PROP. 99 cm. Reduc: 3.38/1 (TOP) BIPALE Bois 99 cm. Reduc: 3.38/1 (TOP)	TOP80	193,75 €
	H08	BIPALA Madera 130 cm. (TOP) *NO ES ACONSEJABLE WOOD 2-BLADE PROP. 130 cm. (TOP) *We do not recomend BIPALE Bois 130 cm. (TOP) *Nous ne recommand pas	TOP80	193,75 €
	H09	BIPALA Madera 115 cm. Reduc: 3.6/1 (TOP) WOOD 2-BLADE PROP. 115 cm. Reduc: 3.6/1 (TOP) BIPALE Bois 115 cm. Reduc: 3.6/1 (TOP)	TOP80	193,75 €
	H10	BIPALA Madera 115 cm. Reduc: 3.9/1 (TOP) WOOD 2-BLADE PROP. 115 cm. Reduc: 3.9/1 (TOP) BIPALE Bois 115 cm. Reduc: 3.9/1 (TOP)	TOP80	193,75 €

	H11	BIPALA Carbono 115 cm. Reduc: 3.9/1 HELIX (TOP) CARBON 2-BLADE HELIX PROP. 115 cm. Reduc: 3.9/1 (TOP) BIPALE Carbone 115 cm. Reduc: 3.9/1 HELIX (TOP)	TOP80	265,00 €
	H12	BIPALA Madera 125 cm. Reduc: 3.6/1 (TOP) WOOD 2-BLADE PROP. 125 cm. Reduc: 3.6/1 (TOP) BIPALE Bois 125 cm. Reduc: 3.6/1 (TOP)	TOP80	193,75 €
	H13	BIPALA Madera 125 cm. Reduc: 3.9/1 (TOP) WOOD 2-BLADE PROP. 125 cm. Reduc: 3.9/1 (TOP) BIPALE Bois 125 cm. Reduc: 3.9/1 (TOP)	TOP80	193,75 €
	H14	BIPALA Carbono 125 cm. Reduc: 3.9/1 HELIX (TOP) CARBON 2-BLADE HELIX PROP. 125 cm. Reduc: 3.9/1 (TOP) BIPALE Carbone 125 cm. Reduc: 3.9/1 HELIX (TOP)	TOP80	265,00 €
	H14S	BIPALA Carbono 130 cm. Reduc: 3.9/1 HELIX (TOP) CARBON 2-BLADE HELIX PROP. 130 cm. Reduc: 3.9/1 (TOP) BIPALE Carbone 130 cm. Reduc: 3.9/1 HELIX (TOP)	TOP80	265,00 €
	H15	BIPALA Madera 115 cm. (FLY 100 EVO) WOOD 2-BLADE PROP. 115 cm. (FLY 100 EVO) BIPALE Bois 115 cm. (FLY 100 EVO)	FLY100	193,75 €
	H16	BIPALA Carbono 115 cm. HELIX (FLY 100 EVO) CARBON 2-BLADE HELIX PROP. 115 cm. (FLY 100 EVO) BIPALE Carbone 115 cm. HELIX (FLY 100 EVO)	FLY100	265,00 €
	H17	BIPALA Madera 125 cm. (FLY 100 EVO) WOOD 2-BLADE PROP. 125 cm. (FLY 100 EVO) BIPALE Bois 125 cm. (FLY 100 EVO)	FLY100	193,75 €
	H18	BIPALA Carbono 125 cm. HELIX (FLY 100 EVO) CARBON 2-BLADE HELIX PROP. 125 cm. (FLY 100 EVO) BIPALE Carbone 125 cm. HELIX (FLY 100 EVO)	FLY100	265,00 €
	H19	BIPALA Madera 115 cm. (ROS 100) WOOD 2-BLADE PROP. 115 cm. (ROS 100) BIPALE Bois 115 cm. (ROS 100)	ROS100	193,75 €
	H20	BIPALA Carbono 115 cm. HELIX (ROS 100) CARBON 2-BLADE HELIX PROP. 115 cm. (ROS 100) BIPALE Carbone 115 cm. HELIX (ROS 100)	ROS100	265,00 €
	H21	BIPALA Madera 125 cm. (ROS 100)) WOOD 2-BLADE PROP. 125 cm. (ROS 100) BIPALE Bois 125 cm. (ROS 100)	ROS100	193,75 €
	H22	BBIPALA Carbono 125 cm. HELIX (ROS 100) CARBON 2-BLADE HELIX PROP. 125 cm. (ROS 100) BIPALE Carbone 125 cm. HELIX (ROS 100)	ROS100	265,00 €
	H23	BIPALA Madera 115 cm. (ROS 125) WOOD 2-BLADE PROP. 115 cm. (ROS 125) BIPALE Bois 115 cm. (ROS 125)	ROS125	193,75 €
	H24	BIPALA Carbono 115 cm. HELIX (ROS 125) CARBON 2-BLADE HELIX PROP. 115 cm. (ROS 125) BIPALE Carbone 115 cm. HELIX (ROS 125)	ROS125	265,00 €
	H25	BIPALA Madera 125 cm. (ROS 125) WOOD 2-BLADE PROP. 125 cm. (ROS 125) BIPALE Bois 125 cm. (ROS 125)	ROS125	193,75 €
	H26	BIPALA Carbono 125 cm. HELIX (ROS 125) CARBON 2-BLADE HELIX PROP. 125 cm. (ROS 125) BIPALE Carbone 125 cm. HELIX (ROS 125)	ROS125	265,00 €
	H27	BIPALA Madera 125 cm. Reduc: 2.5/1 (FLY 200) WOOD 2-BLADE PROP. 125 cm. Reduc: 2.5/1 (FLY 200) BIPALE Bois 125 cm. Reduc: 2.5/1 (FLY 200)	F200	193,75 €
	H28	BIPALA Madera 125 cm. Reduc: 3.1/1 (FLY 200) WOOD 2-BLADE PROP. 125 cm. Reduc: 3.1/1 (FLY 200) BIPALE Bois 125 cm. Reduc: 3.1/1 (FLY 200)	F200	193,75 €
	H29	TRIPALA Carbono 125 cm. Reduc: 3.1/1 HELIX (FLY 200) CARBON 3-BLADE HELIX PROP. 125 cm. Reduc: 3.1/1 (FLY 200) TRIPALE Carbone 125 cm. Reduc: 3.1/1 HELIX (FLY 200)	F200	381,25 €

	H01	BIPALA Madera 99 cm. (CORSAIR) WOOD 2-BLADE PROP. 99 cm. (CORSAIR) BIPALE Bois 99 cm. (CORSAIR)	CORSAIR	193,75 €
	H02	BIPALA Madera 113 cm. (CORSAIR) WOOD 2-BLADE PROP. 113 cm. (CORSAIR) BIPALE Bois 113 cm. (CORSAIR)	CORSAIR	193,75 €
	H03	BIPALA Madera 122 cm. (CORSAIR) WOOD 2-BLADE PROP. 122 cm. (CORSAIR) BIPALE Bois 122 cm. (CORSAIR)	CORSAIR	193,75 €
	H250	BIPALA Carbono 125 cm. E-PROPS (CORSAIR) CARBON 2-BLADE E-PROPS PROP. 125 cm. (CORSAIR) BIPALE Carbone 125 cm. E-PROPS (CORSAIR)	CORSAIR	265,00 €
	H251	BIPALA Carbono 130 cm. E-PROPS (CORSAIR) CARBON 2-BLADE E-PROPS PROP. 130 cm. (CORSAIR) BIPALE Carbone 130 cm. E-PROPS (CORSAIR)	CORSAIR	265,00 €
	H04	BIPALA Madera 99 cm. 39 x 18. Reduc: 1.8/1 (SOLO) WOOD 2-BLADE PROP. 99 cm. 39 x 18. Reduc: 1.8/1 (SOLO) BIPALE Bois 99 cm. 39 x 18. Reduc: 1.8/1 (SOLO)	SOLO	193,75 €
	H05	BIPALA Madera 99 cm. 39 x 26. Reduc: 2.2/1 (SOLO) WOOD 2-BLADE PROP. 99 cm. 39 x 26. Reduc: 2.2/1 (SOLO) BIPALE Bois 99 cm. 39 x 26. Reduc: 2.2/1 (SOLO)	SOLO	193,75 €
	H43	BIPALA Carbono 130 cm. HELIX (ELECTRIC DB15) CARBON 2-BLADE HELIX PROP. 130 cm. (ELECTRIC DB15) BIPALE Carbone 130 cm. HELIX (ELECTRIC DB15)	ELECTRIC DB15	265,00 €

CARBURADOR CARBURETTOR CARBURATEUR **WALBRO 24**

PVP

	C006	CARBURADOR WALBRO 24 CARBURETTOR WALBRO 24 CARBURATEUR WALBRO 24		175,00 €
	C006T	CARBURADOR WALBRO 24 (TOP80) WALBRO 24 CARBURETTOR (TOP80) CARBURATEUR WALBRO24 (TOP80)	TOP80	175,00 €
	C006V	CARBURADOR WALBRO 24 (FLY100EVO) WALBRO 24 CARBURETTOR (FLY100EVO) CARBURATEUR WALBRO24 (FLY100EVO)	FLYEVO100	175,00 €
	C006R	CARBURADOR WALBRO 24 (ROS125) WALBRO 24 CARBURETTOR (ROS125) CARBURATEUR WALBRO24 (ROS125)	ROS125	175,00 €
	RM502	CARBURADOR WALBRO 24 (RM80) WALBRO 24 CARBURETTOR (RM80) CARBURATEUR WALBRO24 (RM80)	RM80	175,00 €
	PA502	CARBURADOR WALBRO 24 (PA125) WALBRO 24 CARBURETTOR (PA125) CARBURATEUR WALBRO24 (PA125)	PA125	175,00 €
	928.440.001	CARBURADOR WALBRO WG8 CARBURETTOR WALBRO WG8 CARBURATEUR WALBRO WG8	THOR130	223,95 €
	C011A	KIT REPARACION CARBURADOR WALBRO 24 REPAIR KIT CARBURETTOR WALBRO 24 KIT REPARATION CARBURATEUR WALBRO 24		15,00 €
	C011B	KIT MEMBRANA WALBRO 24 MEMBRANE SET WALBRO 24 KIT MEMBRANE WALBRO 24		8,75 €

CARBURADOR CARBURETTOR CARBURATEUR **WALBRO 32**

PVP

	C011	KIT REPARACION CARBURADOR WALBRO 32 REPAIR KIT CARBURETTOR WALBRO 32 KIT REPARATION CARBURATEUR WALBRO 32		12,50 €
--	------	---	--	---------

CARBURADOR CARBURETTOR CARBURATEUR **WALBRO 37**

PVP

	F260	CARBURADOR WALBRO 37 CARBURETTOR WALBRO 37 CARBURATEUR WALBRO 37		150,85 €
	VM090	CARBURADOR WALBRO 37 MOSTER WALBRO 37 MOSTER CARBURETTOR CARBURATEUR WALBRO 37 MOSTER	MOSTER	162,50 €
	VMP090	CARBURADOR WALBRO MOSTER185PLUS WALBRO MOSTER185PLUS CARBURETTOR CARBURATEUR WALBRO MOSTER185PLUS	MOSTER185plus	162,50 €
	928.440.010	CARBURADOR WALBRO WB37 THOR 200 CARBURETTOR WALBRO WB37 THOR 200 CARBURATEUR WALBRO WB37 THOR 200	THOR200	205,30 €
	VM097	KIT REPARACION CARBURADOR WALBRO WB SERIES MEMBRANES AND GASKETS WALBRO WB KIT REPARATION CARBURATEUR WALBRO WB		13,50 €
	928.440.011	KIT REPARACION CARBURADOR WALBRO WB37 WALBRO WB37 CARBURETTOR REPAIR KIT KIT REPARATION WALBRO WB37 CARBURATEUR		13,50 €

ATOM80

BLOQUE MOTOR
MOTOR BLOCK
BLOQUE MOTEUR

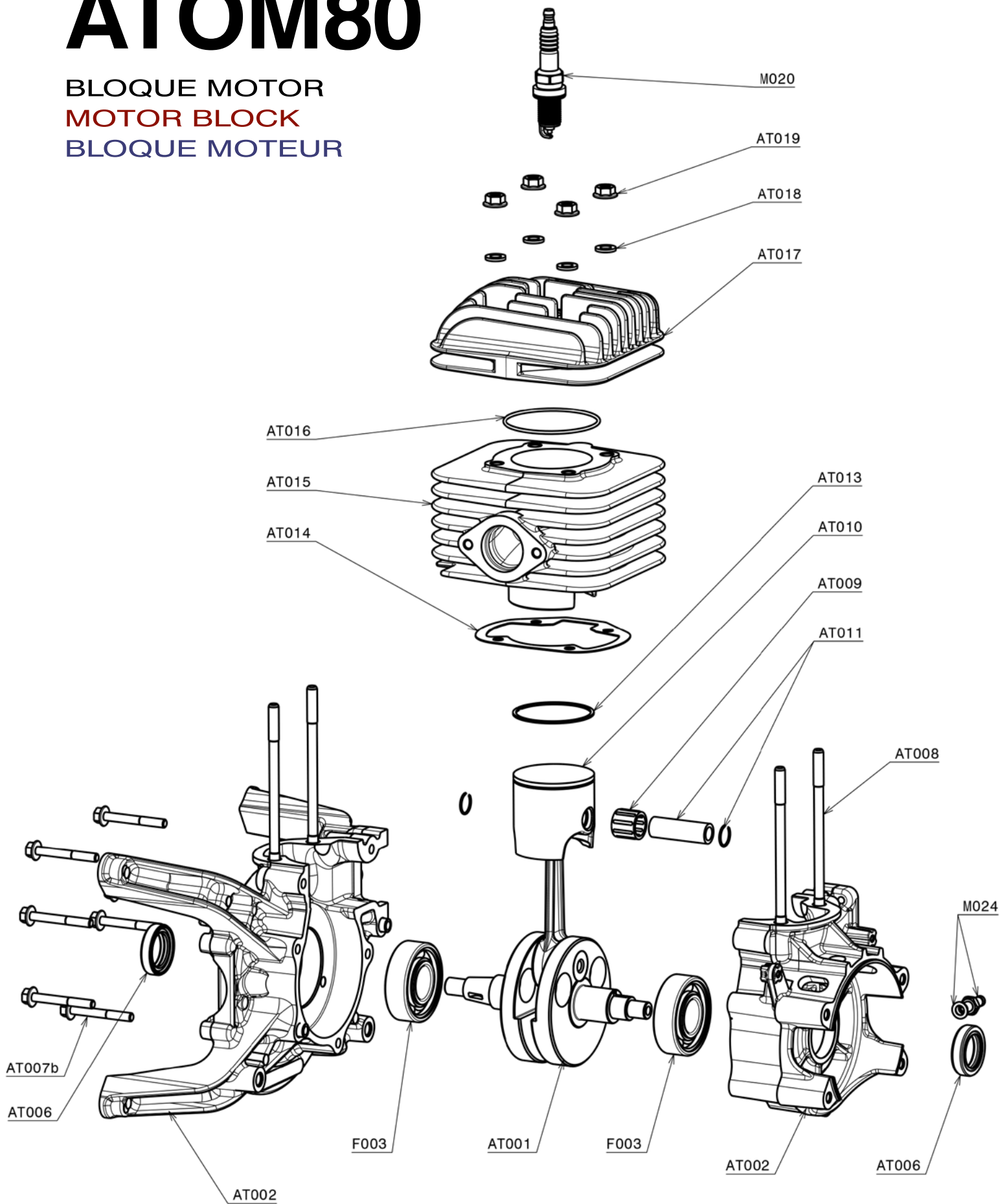

ATOM80

REDUCTORA
REDUCTOR
REDUCTEUR

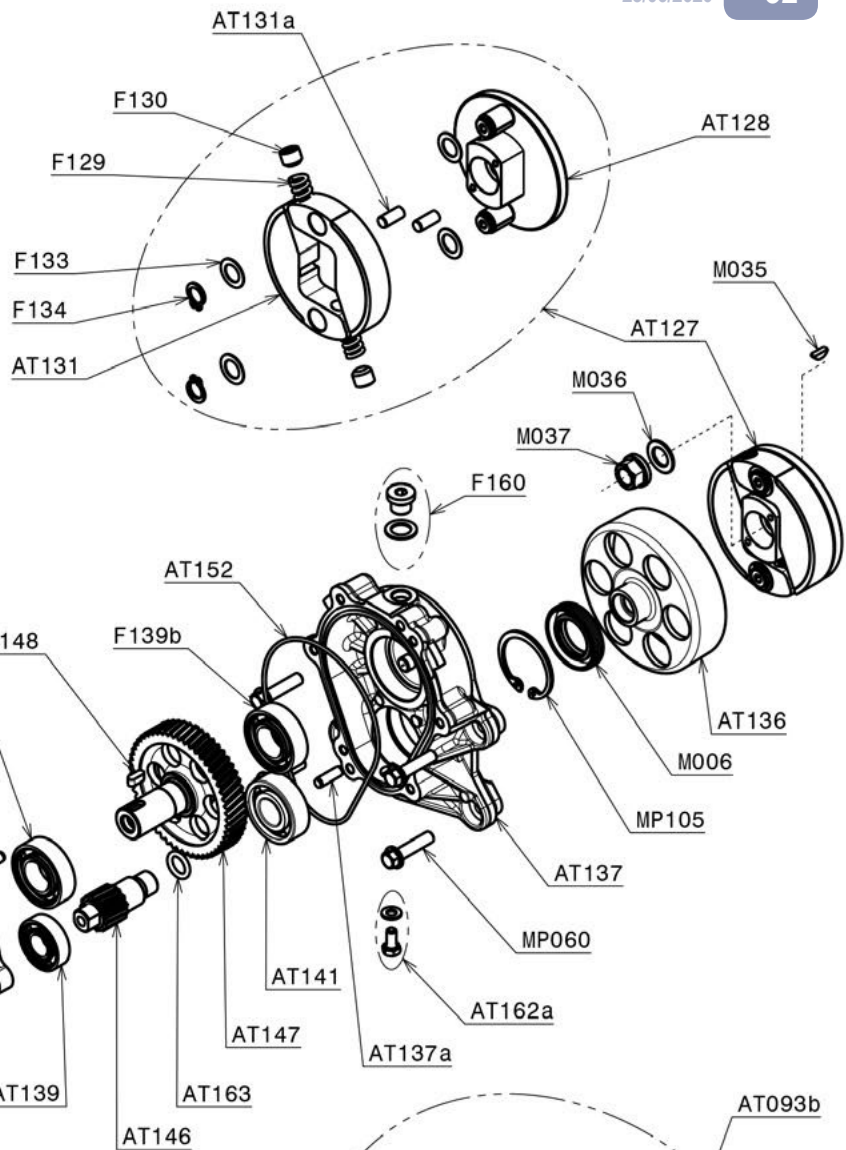
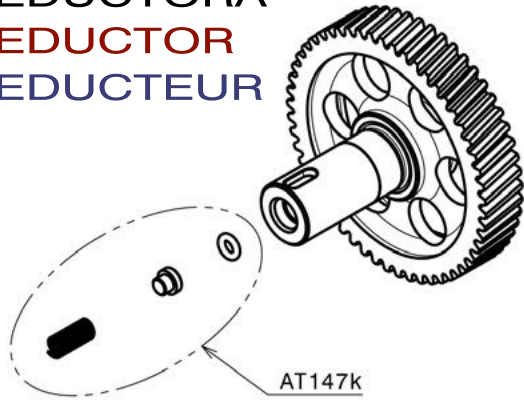

ATOM80

ADMISION
ADMISSION
ADMISSION

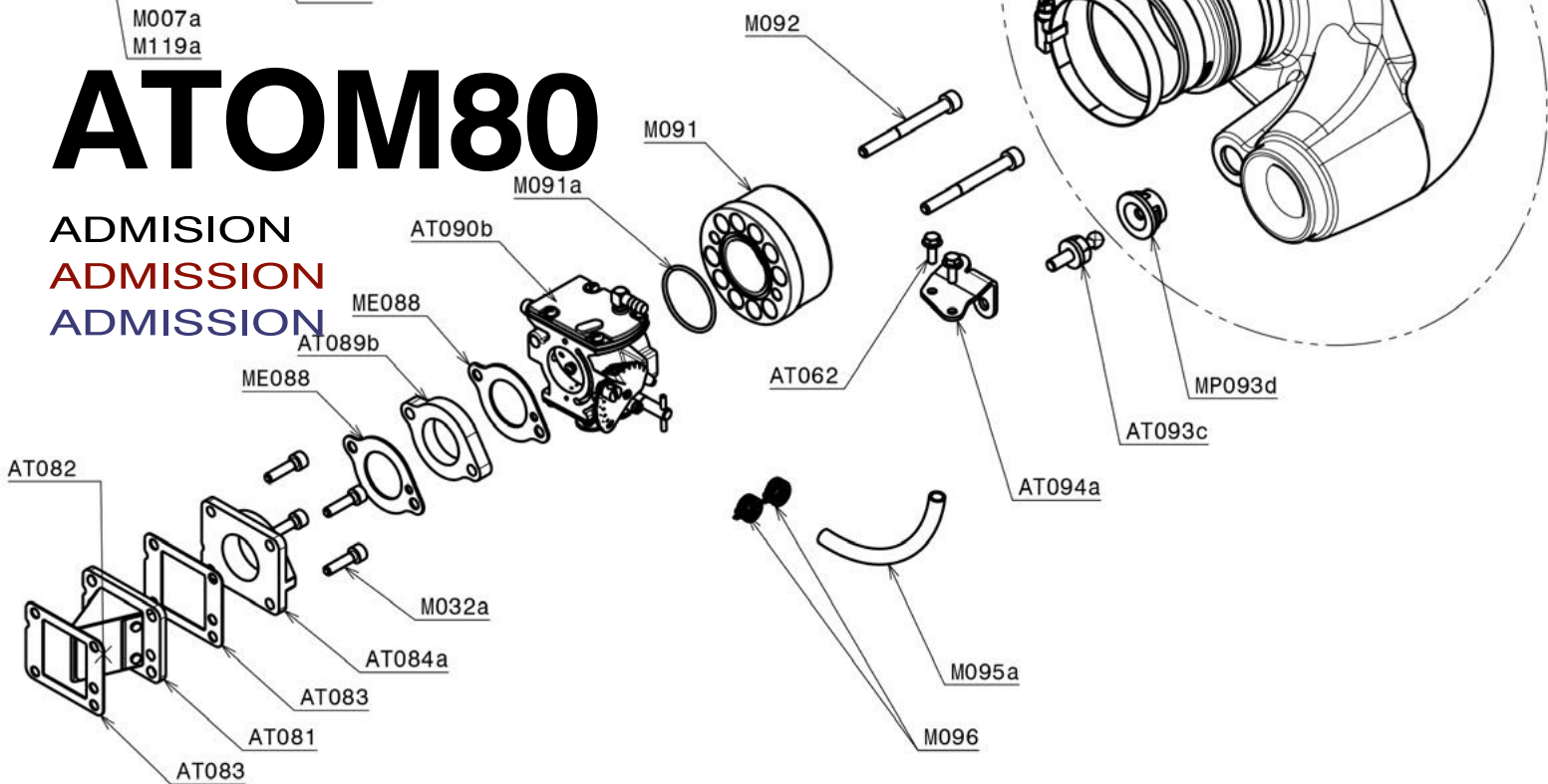

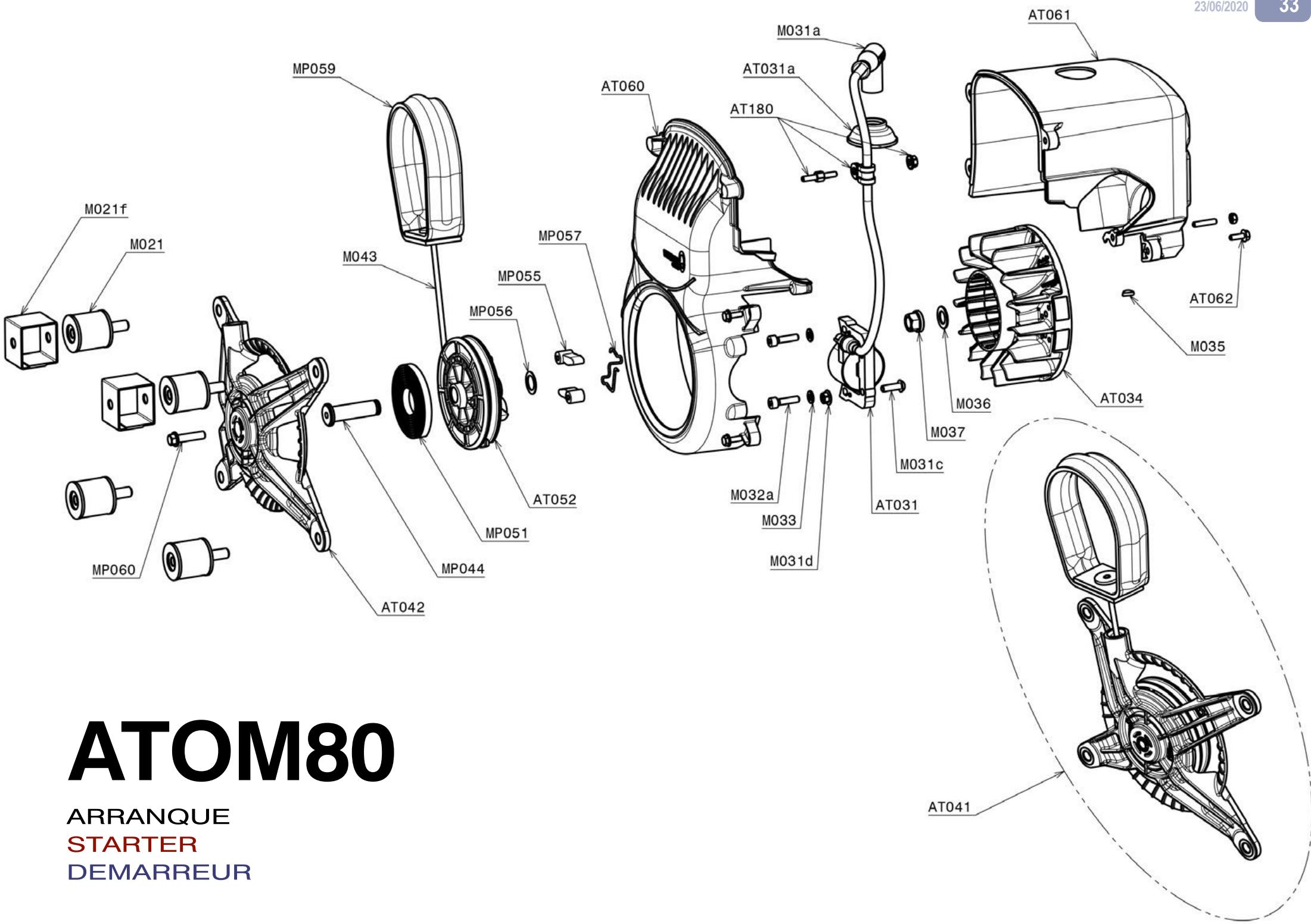

ATOM80

ARRANQUE
STARTER
DEMARREUR

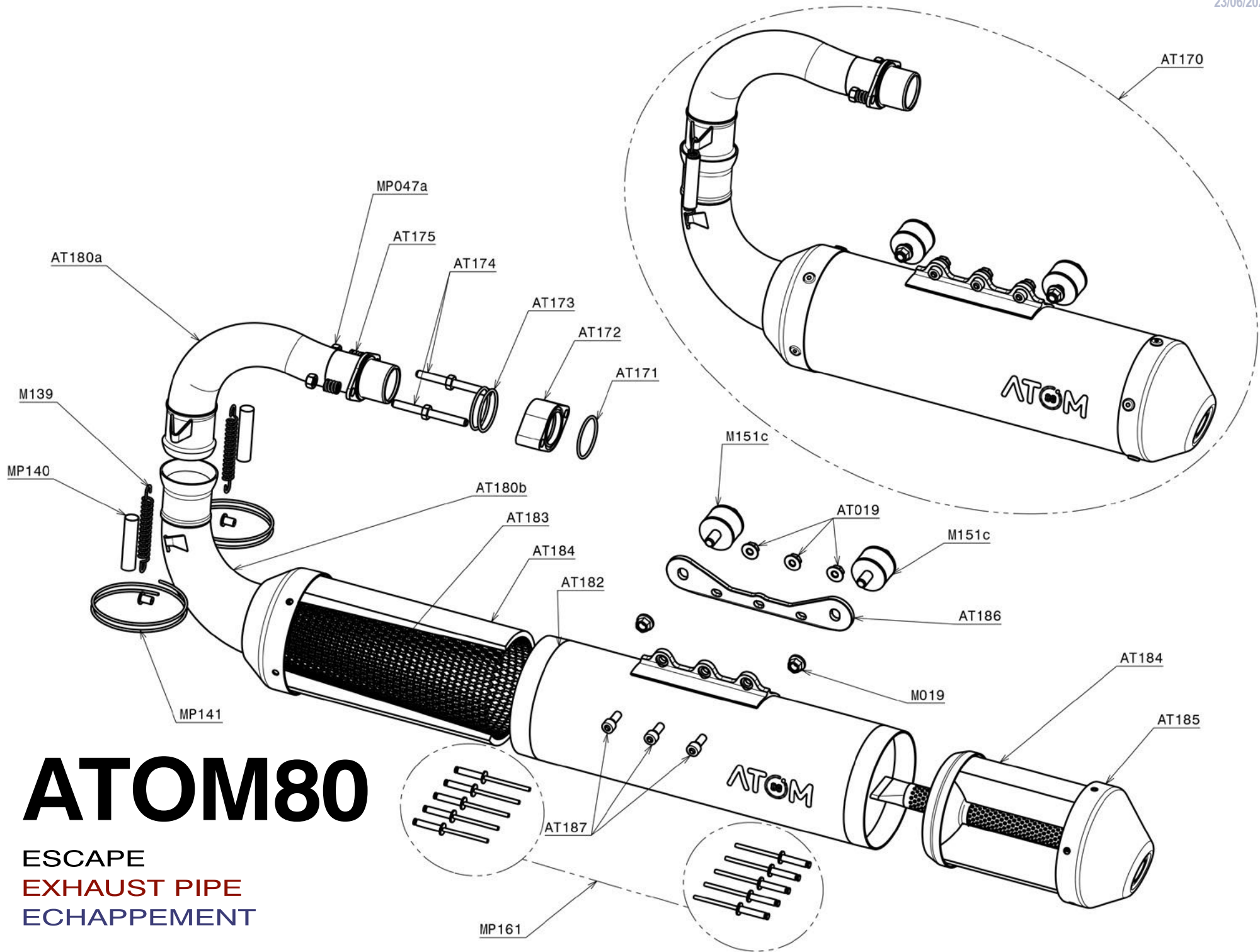

ATOM80





ESCAPE
EXHAUST PIPE
ECHAPPEMENT

ATOM80

BLOQUE MOTOR
MOTOR BLOCK
BLOQUE MOTEUR

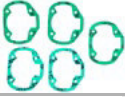
page
1/2

PVP

	AT001	CIGUEÑAL CON VIELA(INC. M036 - M037) CRANKSHAFT WITH PUSH ROD (INC. M036 - M037) VILLEBREQUIN AVEC BIELE (INC. M036 - M037)	220,00 €
	AT002	BLOQUE MOTOR CARTER, NEGRO (INCL AT007 - M032A - AT008- AT007A) ENGINE CARTER BLOCK, BLACK (INCL AT007 - M032A - AT008- AT007A) BLOC MOTEUR NOIR (INCL AT007 - M032A - AT008- AT007A)	208,75 €
	AT006	RETENES 20/30/7 MM (SET DE 2) OIL SEALS VITON 20/30/7 MM (SET OF 2) JOINTS SPY 20/30/7 MM (SET OF 2)	10,00 €
	AT007	TORNILLO 5 X 40 MM TCEI DIN912, NEGRO (SET DE 7) BOLT 5 X 40 MM TCEI DIN912, BLACK (SET OF 7) VIS 5 X 40 MM TCEI DIN912, NOIR (SET DE 7)	2,19 €
	AT007a	TAPA DE GOMA RUBBER CAP BOUCHON EN CAOUTCHOUC	1,25 €
	AT007b	TORNILLO 5 X 40 MM Tef DIN6921, NEGRO (SET DE 7) BOLT 5 X 40 MM Tef DIN6921, BLACK (SET OF 7) VIS 5 X 40 MM Tef DIN6921, NOIR (SET DE 7)	3,50 €
	AT008	JUEGO DE ESPÁRRAGOS CILINDRO 6 X 108 MM (SET OF 4) CYLINDER STUD 6 X 108 MM (SET OF 4) KIT AXE DE CYLINDER 6 X 108 MM (SET OF 4)	20,00 €
	AT009	RODAMIENTO DE AGUJAS PISTON ROLLER BEARING ROULEMENT DU PISTON	12,50 €
	AT010a	PISTON COMPLETO Ø 47,6 MM SEL. A (INC AT011 - AT012 - AT013) PISTON COMPLETE Ø 47,6 MM SEL. A (INC AT011 - AT012 - AT013) PISTON COMPLET Ø 47,6 MM SEL. A (INC AT011 - AT012 - AT013)	68,75 €
	AT010b	PISTON COMPLETO Ø 47,6 MM SEL. B (INC AT011 - AT012 - AT013) PISTON COMPLETE Ø 47,6 MM SEL. B (INC AT011 - AT012 - AT013) PISTON COMPLET Ø 47,6 MM SEL. B (INC AT011 - AT012 - AT013)	68,75 €
	AT010c	PISTON COMPLETO Ø 47,6 MM SEL. C (INC AT011 - AT012 - AT013) PISTON COMPLETE Ø 47,6 MM SEL. C (INC AT011 - AT012 - AT013) PISTON COMPLET Ø 47,6 MM SEL. C (INC AT011 - AT012 - AT013)	68,75 €
	AT011	CLIPS DE BOULON Ø 12MM PISTON PIN Ø 12MM CLIPS DE BOULONS Ø 12MM	9,38 €
	AT012	PIN LOCK RINGS (SET OF 2) PIN LOCK RINGS (SET OF 2) PIN LOCK RINGS (SET OF 2)	2,50 €
	AT013	SEGMENTO DE PISTON GS10 CROMADO PISTON RING GS10 CHROMED SEGMENT DU PISTON GS10 CHROMED	13,75 €
	AT014	JUNTA DE CILINDRO - 0,20/0,30/0,50 MM (SET DE 5) CYLINDER GASKETS - 0,20/0,30/0,50 MM (SET OF 5) JOINT D'EMBASE - 0,20/0,30/0,50 MM (SET DE 5)	5,63 €
	AT015a	CILINDRO CROMADO Ø 47,6 MM SEL.A CYLINDER CHROMED Ø 47,6 MM SEL.A CILINDRE CHROMÉ Ø 47,6 MM SEL.A	158,75 €
	AT015b	CILINDRO CROMADO Ø 47,6 MM SEL.B CYLINDER CHROMED Ø 47,6 MM SEL.B CILINDRE CHROMÉ Ø 47,6 MM SEL.B	158,75 €
	AT015c	CILINDRO CROMADO Ø 47,6 MM SEL.C CYLINDER CHROMED Ø 47,6 MM SEL.C CILINDRE CHROMÉ Ø 47,6 MM SEL.C	158,75 €
	AT016	JUNTA DE CULATA Ø 53,70 X 1,78 MM O-RING VITON Ø 53,70 X 1,78 MM JOINT DE CULASSE Ø 53,70 X 1,78 MM	2,50 €
	AT017	CULATA (INC AT016) CYLINDER HEAD (INC AT016) CULASSE (INC AT016)	55,00 €
	AT018	ARANDELA Ø 6 X 12 MM DIN 125A (SET OF 4) WASHER Ø 6 X 12 MM DIN 125A (SET OF 4) RONDELLE Ø 6 X 12 MM DIN 125A (SET OF 4)	1,25 €

ATOM80

BLOQUE MOTOR
MOTOR BLOCK
BLOQUE MOTEUR

 page
2/2

PVP



AT019	TUERCA AUTOBLOCANTE DE ALTA TEMPERATURA 6 X 1 MM (SET DE 4) LOCK NUT HIGH TEMPERATURE 6 X 1 MM (SET OF 4) ECROUS AUTO BLOQUANT HAUT TEMPÉRATURE 6 X 1 MM (SET OF 4)	4,00 €
AT025	Complete series of gaskets and O-ring Complete series of gaskets and O-ring Complete series of gaskets and O-ring	25,00 €



ATOM80

REDUCTORA
REDUCTOR
RÉDUCTEUR

 page
1/2

PVP

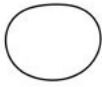
F003	RODAMIENTO 47/20/14 MM - TVH - C3 (SET DE 2) BEARING 47/20/14 MM - TVH - C3 (SET OF 2) ROULEMENT 47/20/14 MM - TVH - C3 (SET DE 2)	25,00 €
VM020	BUJIA NGK BR9ES SPARK PLUG NGK BR9ES BOUGIE NGK BR9ES	7,50 €
 AT127	EMBRAGUE COMPLETO CLUTCH COMPLETE EMBRAYAGE COMPLET	85,00 €
AT128	BASE DE EMBRAGUE CON ESPÁRRAGOS BASE CLUTCH WITH STUDS BASE DE EMBRAGASE AVEC GOUJONS	32,50 €
AT131	BLOCKS CLUTCH (SET OF 2) BLOCKS CLUTCH (SET OF 2) BLOCKS CLUTCH (SET OF 2)	48,75 €
AT131a	TAPA DE PLÁSTICO PARA EMBRAGUE (SET OF 2) PLASTIC CAP FOR BLOCKS CLUTCH (SET OF 2) BOUCHON EN PLASTIQUE POUR EMBRAYAGE (SET OF 2)	5,00 €
 AT136	DRUM CLUTCH DRUM CLUTCH DRUM CLUTCH	40,00 €
AT137	ALUMINIUM REDUCTION DRIVE CASE, BACK PART, BLACK ALUMINIUM REDUCTION DRIVE CASE, BACK PART, BLACK ALUMINIUM REDUCTION DRIVE CASE, BACK PART, BLACK	118,75 €
AT137a	PASADOR DE CENTRADO (SET OF 2) CENTERING PIN (SET OF 2) GOUPILLE DE CENTRAGE (SET OF 2)	3,75 €
AT138	ALUMINIUM REDUCTION DRIVE CASE, FRONT PART, BLACK ALUMINIUM REDUCTION DRIVE CASE, FRONT PART, BLACK ALUMINIUM REDUCTION DRIVE CASE, FRONT PART, BLACK	63,75 €
AT139	RODAMIENTO 12/28/8 MM - 6001 - C3 BEARING 12/28/8 MM - 6001 - C3 ROULEMENT 12/28/8 MM - 6001 - C3	7,50 €
AT141	RODAMIENTO 15/32/9 MM - 6202 - C3 BEARING 15/32/9 MM - 6202 - C3 ROULEMENT 15/32/9 MM - 6202 - C3	7,50 €
AT143	RETÉN 25/35/7 MM OIL SEAL VITON 25/35/7 MM JOINT SPY 25/35/7 MM	5,00 €
AT146	PIÑÓN 14 TEETH (1/3.8) REDUCTION GEARING 14 TEETH (1/3.8) PIGNON 14 TEETH (1/3.8)	52,50 €
AT147	PIÑÓN 53 TEETH (1/3.8) REDUCTION GEARING 53 TEETH (1/3.8) PIGNON 53 TEETH (1/3.8)	118,75 €
AT147k	KIT OIL BREATH VALVE KIT OIL BREATH VALVE KIT OIL BREATH VALVE	8,75 €
AT148	SEEGER Ø 15 MM DIN 472 (SET OF 2) SEEGER Ø 15 MM DIN 472 (SET OF 2) SEEGER Ø 15 MM DIN 472 (SET OF 2)	0,63 €
AT149	HUBBER CENTER & FIXING PROPELLER, ORANGE HUBBER CENTER & FIXING PROPELLER, ORANGE HUBBER CENTER & FIXING PROPELLER, ORANGE	36,25 €







	AT150	TUERCA ESPECIAL 8 X 20 MM TCEI DIN912, NEGRA SPECIAL BOLT 8 X 20 MM TCEI DIN912, BLACK ECROU SPECIAL 8 X 20 MM TCEI DIN912, NOIR	3,13 €
	AT151	COPPER WASHER Ø 8 X 14 MM DIN 7603A (SET OF 2) COPPER WASHER Ø 8 X 14 MM DIN 7603A (SET OF 2) COPPER WASHER Ø 8 X 14 MM DIN 7603A (SET OF 2)	1,25 €
	AT152	JUNTA TÓRICA VITON 88,62 X 1,78 MM O-RING VITON 88,62 X 1,78 MM JOINT TORIQUE 88,62 X 1,78 MM	2,50 €
	AT155	CONTRA PLACA HELICE FLANGE PROPELLER, ORANGE CONTRE PLAQUE HELICE	8,75 €
	AT160	Aceite para carter reductora Oil for reduction gear 30 ml Huile pour carter reducteur	8,75 €
	AT161	Reduction drive complete (1/3.8), black Reduction drive complete (1/3.8), black Reduction drive complete (1/3.8), black	475,00 €
	AT162	LOWER BOLT CAP AND COPPER WASHER Ø 5 LOWER BOLT CAP AND COPPER WASHER Ø 5 LOWER BOLT CAP AND COPPER WASHER Ø 5	1,25 €
	AT162a	PERNO MAGNÉTICO INFERIOR M10X1 Y ARANDELA DE COBRE Ø 10 MAGNETIC LOWER BOLT CUP M10X1 AND COPPER WASHER Ø 10 COUPELLE MAGNÉTIQUE INFÉRIEURE M10X1 ET RONDELLE CUIVRE Ø 10	4,38 €
	AT163	JUNTA TÓRICA 9,92 X 2,62 MM O-RING VITON 9,92 X 2,62 MM JOINT TRIQUE 9,92 X 2,62 MM	2,50 €
	AT164	JUNTA TÓRICA VITON 17 X 1,00 MM O-RING VITON 17 X 1,00 MM JOINT TORIQUE 17 X 1,00 MM	2,50 €
	AT165	SEPARADOR DE RODAMIENTO BEARING SPEACER SEPARATEUR ROULEMENT	3,75 €
	F129	MUELLE DEL EMBRAGUE (SET OF 2) SPRING CLUTCH (SET OF 2) RESSORT EMBRAYAGE (SET DE 2)	4,38 €
	F130	TORNILLO 10 X 1.5 MM (SET DE 2) SCREW 10 X 1.5 MM (SET OF 2) VIS 10 X 1.5 MM (SET DE 2)	1,25 €
	F133	ARANDELA Ø 10 EXT. 18 MM DIN 988PS (SET DE 4) WASHER Ø 10 EXT. 18 MM DIN 988PS (SET OF 4) RONDELLE Ø 10 EXT. 18 MM DIN 988PS (SET DE 4)	1,25 €
	F134	SEEGER Ø 10 MM DIN 471 (SET OF 2) SEEGER Ø 10 MM DIN 471 (SET OF 2) SEEGER Ø 10 MM DIN 471 (SET OF 2)	0,63 €
	F139b	RODAMIENTO 17/35/10 MM - 6003 - C3 BEARING 17/35/10 MM - 6003 - C3 ROULEMENT 17/35/10 MM - 6003 - C3	7,50 €
	F148	CHAVETA 4 X 10 MM UNI 6604-4 (SET DE 2) KEY-HOLE TANG 4 X 10 MM UNI 6604-4 (SET OF 2) CLAVETTE 4 X 10 MM UNI 6604-4 (SET DE 2)	2,50 €
	F160	UPPER BOLT CAP AND COPPER WASHER Ø 10 UPPER BOLT CAP AND COPPER WASHER Ø 10 UPPER BOLT CAP AND COPPER WASHER Ø 10	1,88 €
	VM006	RETENES 20/30/7 MM (SET DE 2) OIL SEALS VITON 20/30/7 MM (SET OF 2) JJOINTS SPY 20/30/7 MM (SET OF 2)	10,00 €
	VM007a	BOLT 6 X 40 MM TCEI DIN912, BLACK (SET OF 6) BOLT 6 X 40 MM TCEI DIN912, BLACK (SET OF 6) BOLT 6 X 40 MM TCEI DIN912, BLACK (SET OF 6)	3,75 €

VM032a	TORNILLO 5 X 20 MM TCEI DIN 912, NEGRO (SET DE 6) BOLT 5 X 20 MM TCEI DIN 912, BLACK (SET OF 6) VIS 5 X 20 MM TCEI DIN 912, NOIR (SET DE 6)	1,88 €
VM035	CHAVETA 3 X 3,7 MM DIN 6888 (SET OF 2) KEY-HOLE TANG 3 X 3,7 MM DIN 6888 (SET OF 2) CLAVETTE 3 X 3,7 MM DIN 6888 (SET DE 2)	2,50 €
VM036	ARANDELA DEL MUELLE ONDULADA Ø 10 EST. 18 MM DIN137B ONDULATED SPRING WASHER Ø 10 EST. 18 MM DIN137B RONDELLE DU RESSORT ONDULÉE Ø 10 EST. 18 MM DIN137B	0,63 €
VM037	TUERCA ESCALONADA 10 X 1.25 MM NUT WITH FLANGE 10 X 1.25 MM ECROU 10 X 1.25 MM	2,50 €
VM085	TORNILLO 5 X 25 MM TCEI DIN 912, NEGRO (SET DE 6) BOLT 5 X 25 MM TCEI DIN 912, BLACK (SET OF 6) VIS 5 X 25 MM TCEI DIN 912, NOIR (SET DE 6)	2,50 €
VM119a	Bolt 6 x 50 mm Tcei DIN912, black (Set of 6) Bolt 6 x 50 mm Tcei DIN912, black (Set of 6) Bolt 6 x 50 mm Tcei DIN912, black (Set of 6)	3,75 €
VMP105	SEEGER Ø 35 MM DIN 472 (SET OF 2) SEEGER Ø 35 MM DIN 472 (SET OF 2) SEEGER Ø 35 MM DIN 472 (SET OF 2)	1,25 €

ATOM80

ADMISION
ADMISSION
ADMISSION

AT062	TORNILLO 4 X 12 MM DIN 6921, NEGRO (SET DE 2) BOLT WITH FLANGE 4 X 12 MM DIN 6921, BLACK (SET OF 2) VIS 4 X 12 MM DIN 6921, NOIR (SET DE 2)	1,56 €
AT081	CAJA DE LAMINAS (INC AT083) REED VALVE COMPLETE (INC AT083) BOITE A CLAPETS (INC AT083)	33,75 €
AT082	LAMINAS (SET DE 2) REED VALVE PETALS (SET OF 2) LAMELLES (SET OF 2)	17,50 €
AT083	JUNTA CAJA DE LAMINA (SET DE 2) REED VALVE GASKET (SET OF 2) JOINT BOITE A CLAPETS (SET DE 2)	3,75 €
AT084	PLACA SUJECCIÓN CARBURADOR WG8, NARANJA WG8 CARBURETOR FLANGE, ORANGE PLAQUE CARBURATEUR WG8, ORANGE	22,50 €
AT088	JUNTA CARBURADOR (SET DE 2) CARBURETOR GASKET (SET OF 2) JOINT CARBURATEUR (SET DE 2)	3,75 €
AT089a	BAKELITE GASKET FOR WG8 CARBURETOR BAKELITE GASKET FOR WG8 CARBURETOR BAKELITE GASKET FOR WG8 CARBURETOR	10,00 €
AT089b	BAKELITE GASKET FOR WB CARBURETOR BAKELITE GASKET FOR WB CARBURETOR BAKELITE GASKET FOR WB CARBURETOR	10,00 €
AT090a	CARBURADOR WALBRO WG8 PARA ATOM80 CARBURETOR WALBRO WG8 FOR ATOM80 CARBURATEUR WALBRO WG8 POUR ATOM80	186,25 €
AT090b	CARBURADOR WALBRO WB PARA ATOM80 CARBURETOR WALBRO WB FOR ATOM80 CARBURATEUR WALBRO WB POUR ATOM80	186,25 €
AT091	CONECTOR DE PLATICO AIRBOX (INC M091A) PLASTIC AIR-BOX CONNECTOR (INC M091A) SUPPORT PLASTIQUE AIRBOX (INC M091A)	17,50 €
AT092	TORNILLO 5 X 70 MM TCEI DIN 912, NEGRO (SET DE 2) BOLT 5 X 70 MM TCEI DIN 912, BLACK (SET OF 2) VIS 5 X 70 MM TCEI DIN 912, NOIR (SET DE 2)	1,88 €















	AT092a	ARANDELA Ø 5 X 10 MM DIN 125A (SET DE 2) WASHER Ø 5 X 10 MM DIN 125A (SET OF 2) RONDELLE Ø 5 X 10 MM DIN 125A (SET DE 2)		0,63 €
	AT093	AIRBOX COMPLETO para carburador walbro WG8 AIR-BOX SILENCER COMPLETE for carburettor walbro wg8 AIRBOX COMPLET pour carburateur walbro wg8		65,00 €
	AT093a	GOMA DE UNION AIRBOX CON ESPONJA INCORPORADA AIR-BOX RUBBER MANIFOLD WITH INCORPORATED SPONGE GOMME UNION AIRBOX AVE ÉPONGE INCORPORÉ		28,75 €
	AT093b	AIRBOX COMPLETO PARA CARBURADO WALBRO WB AIR-BOX SILENCER COMPLETE FOR CARBURETTOR WALBRO WB AIRBOX COMPLET POUR CARBURATEUR WALBRO WB		65,00 €
	AT093c	SNAPLOCK MALE E FEMALE Ø 16 MM M6 X 16, GREY SNAPLOCK MALE E FEMALE Ø 16 MM M6 X 16, GREY SNAPLOCK MALE E FEMALE Ø 16 MM M6 X 16, GREY		8,75 €
	AT094	PLACA SOPORTE PARA AIRBOX Y ACCELERADOR PARA CARBURADOR WALBRO WG8 PLATE SUPPORT FOR AIR-BOX AND THROTTLE FOR CARBURETTOR WALBRO WG8 PLAQUE SUPPORT AIRBOX ET ACCELERATEUR POUR CARBURATEUR WALBRO WG8		8,75 €
	AT094a	PLACA SOPORTE PARA AIRBOX Y ACCELERADOR PARA CARBURADOR WALBRO WB8 PLATE SUPPORT FOR AIR-BOX AND THROTTLE FOR CARBURETTOR WALBRO WB8 PLAQUE SUPPORT AIRBOX ET ACCELERATEUR POUR CARBURATEUR WALBRO WB8		8,75 €
	AT095	TUERCA AUTOBLOCANTE ALTA TEMPERATURA M4 DIN 980, NEGRO (SET DE 2) LOCK NUT HIGH TEMPERATURE M4 DIN 980, BLACK (SET OF 2) ECROU AUTONBLOQUANT M4 DIN 980, NOIR (SET DE 2)		0,63 €
	AT097	KIT REPARACION CARBURADOR WALBRO WG8 SERIES MEMBRANES AND GASKETS WALBRO WG8 KIT REPARATION CARBURATEUR WALBRO WG8		18,75 €
	VM024	TORNILLO 6 X 6 TBEI DIN 7380 Y ARANDELA DE COBRE BRASS JUNCTION, BOLT 6 X 6 MM TBEI DIN 7380 AND COPPER WASHER VIS DE 6 X 6 TBEI DIN 7380 ET RONDELLE DE CUIVRE		3,13 €
	VM032a	TORNILLO 5 X 20 MM TCEI DIN 912, NEGRO (SET DE 6) BOLT 5 X 20 MM TCEI DIN 912, BLACK (SET OF 6) VIS 5 X 20 MM TCEI DIN 912, NOIR (SET DE 6)		1,88 €
	VME088	JUNTA CARBURADOR (INT. PULSE CIRCUIT) (SET DE 2) CARBURETOR GASKET (INT. PULSE CIRCUIT) (SET OF 2) JOINT CARBURATEUR (INT. PULSE CIRCUIT) (SET DE 2)		3,75 €
	VM091	CONECTOR DE PLÁSTICO AIR-BOX PLASTIC AIR-BOX CONNECTOR CONNECTEUR DE BOÎTE À AIR EN PLASTIQUE	Includes: M091A	17,50 €
	VM092	TORNILLO 6 X 60 MM TCEI DIN912 (SET OF 2) BOLT 6 X 60 MM TCEI DIN912 (SET OF 2) VIS 6 X 60 MM TCEI DIN912 (SET OF 2)		1,25 €
	VMP093b	SNAPLOCK MALE E FEMALE Ø 16 MM, GREY SNAPLOCK MALE E FEMALE Ø 16 MM, GREY SNAPLOCK MALE E FEMALE Ø 16 MM, GREY		8,75 €
	VMP093c	SNAPLOCK FEMALE Ø 18 MM, BLACK SNAPLOCK FEMALE Ø 18 MM, BLACK SNAPLOCK FEMALE Ø 18 MM, BLACK		3,75 €
	VMP093d	SNAPLOCK FEMALE Ø 16 MM, GREY SNAPLOCK FEMALE Ø 16 MM, GREY SNAPLOCK FEMALE Ø 16 MM, GREY		3,75 €
	VM094	ABRAZADERA AIRBOX 50-70MM FIXING BAND 50-70 MM COLLIER AIRBOX 50-70MM		2,50 €
	VM095	TUBO CARBURADOR 155mm PIPE PRESSURE 155 mm TUBE CARBURATEUR 155mm		2,50 €
	VM095a	TUBO CARBURADOR 115mm PIPE PRESSURE 115 mm TUBE CARBURATEUR 115mm		2,50 €
	VM096	ABRAZADERA METAL Ø 10,5 mm FIXING CLAMP Ø 10,5 mm COLLIER METALIQUE Ø 10,5 mm		1,25 €

	AT031	BOBINA SELETTA (INC M031A - M032A - M033) ELECTRONIC IGNITION COIL (SELETTA) (INC M031A - M032A - M033) BOBINE SELETTA (INC M031A - M032A - M033)	50,00 €
	AT031a	BRIDA DE GOMA DE PIPETA SPARK-PLUG CAP RUBBER FLANGE BRIDE EN CAOUTCHOUC DE PIPETTE	4,38 €
	AT034	VOLANTE (SELETTA) CON CAMPANA DE ALUMINIO FLYWHEEL (SELETTA) WITH ALUMINUM TOOTHED PULLEY INCORPORATED VOLANT (SELETTA) AVEC CLOCHE D'ALUMINIUM	70,00 €
	AT041	ARRANQUE COMPLETO PULL STARTER COMPLETE DEMARREUR COMPLET	70,00 €
	AT042	ESTRUCTURA DE ARRANQUE EN PLASTIC (INC MP044) STARTER STRUCTURE IN PLASTIC (INC MP044) STRUCTURE DEMARREUR EN PLASTIC (INC MP044)	31,25 €
	AT052	POLEA DE PLÁSTICO PLASTIC PULLEY POULIE DE PLASTIQUE	18,75 €
	AT060	CARCASA DE PLÁSTICO FRONTAL PLASTIC AIR-CONVEYOR FRONT SIDE CARCASSE DE PLASTIC FRONTAL	36,25 €
	AT061	CARCASA DE PLÁSTICO ARRIBA PLASTIC AIR-CONVEYOR UPPER SIDE CARCASSE DE PLASTIC HAUTE	32,50 €
	AT085	TORNILLO 6 x 25 mm Tcei DIN912, NEGRO (SET DE 4) BOLT 6 x 25 mm Tcei DIN912, BLACK (SET OF 4) VIS 6 x 25 mm Tcei DIN912, NOIR (SET DE 4)	1,60 €
	AT180	PIPE RETAINING CLIP 08/12 MM, STUD 4 X 30 MM AND NUT WITH FLANGE M4 PIPE RETAINING CLIP 08/12 MM, STUD 4 X 30 MM AND NUT WITH FLANGE M4 PIPE RETAINING CLIP 08/12 MM, STUD 4 X 30 MM AND NUT WITH FLANGE M4	6,25 €
	VM021	SILENTBLOC 30 X 30 MM - M8 X 20 MM (SET OF 2) (INC M018 - M019) ANTIVIBRATION MOUNT 30 X 30 MM - M8 X 20 MM (SET OF 2) (INC M018 - M019) SILENTBLOCK 30 X 30 MM - M8 X 20 MM (SET OF 2) (INC M018 - M019)	11,25 €
	VM021f	CINTAS DE SEGURIDAD (SET OF 2) SAFETY BANDS (SET OF 2) BANDE DE SECURITY (SET OF 2)	3,75 €
	VM031a	PIPETA SELETTA SPARK-PLUG CAP (SELETTA) PIPETTE SELETTA	4,38 €
	VM031c	TORNILLO 5 X 16 MM TBEI DIN 7380 BOLT 5 X 16 MM TBEI DIN 7380 VIS 5 X 16 MM TBEI DIN 7380	0,63 €
	VM031d	TUERCA ESCALONADA M5 DIN 6923 NUT WITH FLANGE M5 DIN 6923 ECROU M5 DIN 6923	0,63 €
	VM032a	TORNILLO 5 X 20 MM TCEI DIN 912, NEGRO (SET DE 6) BOLT 5 X 20 MM TCEI DIN 912, BLACK (SET OF 6) VIS 5 X 20 MM TCEI DIN 912, NOIR (SET DE 6)	1,88 €
	VM032b	TORNILLO 5 X 20 MM Tef DIN 6921, NEGRO (SET DE 6) BOLT 5 X 20 MM Tef DIN 6921, BLACK (SET OF 6) VIS 5 X 20 MM Tef DIN 6921, NOIR (SET DE 6)	1,88 €
	AT085	TORNILLO 6 x 25 mm Tcei DIN912, NEGRO (SET DE 4) BOLT 6 x 25 mm Tcei DIN912, BLACK (SET OF 4) VIS 6 x 25 mm Tcei DIN912, NOIR (SET DE 4)	1,60 €
	VM033	ARANDELA DENTADA AUTOBLOCANTE Ø 5 MM DIN 6798A (SET OF 2) LOCK WASHER TOOTED Ø 5 MM DIN 6798A (SET OF 2) RONDELLE AUTOBLOQUANT Ø 5 MM DIN 6798A (SET OF 2)	0,63 €
	VM035	CHAVETA 3 X 3,7 MM DIN 6888 (SET DE 2) KEY-HOLE TANG 3 X 3,7 MM DIN 6888 (SET OF 2) CLAVETTE 3 X 3,7 MM DIN 6888 (SET DE 2)	2,50 €
	VM036	ARANDELA ONDULADA MUELLE Ø 10.5 X 18.0 MM DIN 137B ONDULATED SPRING WASHER Ø 10.5 X 18.0 MM DIN 137B RONDELLE ONDULÉE Ø 10.5 X 18.0 MM DIN 137B	0,63 €

VM037	TUERCA ESCALONADA 10 X 1.25 MM NUT WITH FLANGE 10 X 1.25 MM ECROU 10 X 1.25 MM	2,50 €
VM043	CUERDA DE ARRANQUE 2,20 M STARTER ROPE 2,20 M CORDE DÉMARREUR 2,2M	3,75 €
VM091a	JUNTA TÓRICA VITON Ø 33,05 X 1,78 MM O-RING VITON Ø 33,05 X 1,78 MM JOINT TORIQUE VITON Ø 33,05 X 1,78 MM	1,88 €
VMP044	EJE CENTRAL DE ARRANQUE (INC MP060- MP045) STARTER CENTRAL PIN (INC MP060- MP045) PIN CENTRAL DEMARREUR (INC MP060- MP045)	10,63 €
VMP051	MUELLE POLEA ARRANQUE RECOIL SPRING RESSORT POULIE DÉMARREUR	8,75 €
VMP055	CLIQUETS (SET DE 2) PLASTIC HOOKS (SET OF 2) CLIQUETS (SET DE 2)	5,00 €
VMP056	KIT ARANDELAS 12 X 18 MM - 0,2/0,3/0,5/1,0 MM DIN 988PS (SET DE 6) SHIM WASHER 12 X 18 MM - 0,2/0,3/0,5/1,0 MM DIN 988PS (SET OF 6) KIT RONDELLES 12 X 18 MM - 0,2/0,3/0,5/1,0 MM DIN 988PS (SET DE 6)	5,00 €
VMP057	CLIP (CLIQUETS) ELASTIC RING FOR HOOKS CLIP (CLIQUETS)	3,75 €
VMP059	ASA ARRANQUE MANUAL STARTER HANDLE POIGNÉE DEMARREUR MANUEL	18,75 €
VMP060	TORNILLO 6 X 25 MM TEF (SET DE 4) BOLT 6 X 25 MM TEF (SET OF 4) VIS 6 X 25 MM TEF (SET DE 4)	2,50 €
AT019	TUERCA AUTOBLOCANTE DE ALTA TEMPERATURA 6 X 1,00 MM DIN 6923 (SET DE 4) LOCK NUT HIGH TEMPERATURE 6 X 1,00 MM DIN 6923 (SET OF 4) ECROUS AUTOBLOQUANT DET EMPÉRATURE ÉLEVÉE 6 X 1,00 MM DIN 6923 (SET DE 4)	4,00 €
AT170	ESCAPE COMPLETO, CON SILENCIADOR Y PLACA (INC AT180A - AT180B - M139 - MP140 - MP141) COMPLETE CHROMED MUFFLER, ASSEMBLED WITH SILENCER AND PLATE (INC AT180A - AT180B - M139 - MP140 - MP141) ECHAPEMENT COUPLET AVE SILENCIEUX ET PLAQUE (INC AT180A - AT180B - M139 - MP140 - MP141)	425,00 €
AT171	JUNTA TÓRICA VITON 1,78 X 31,47 MM (SET DE 2) O-RING VITON 1,78 X 31,47 MM JOINT TORIQUE VITON 1,78 X 31,47 MM (SET DE 2)	2,50 €
AT172	ROTULA ESCAPE, NEGRO (INC AT173 - AT171) EXHAUST MANIFOLD, BLACK (INC AT173 - AT171) JOINT D'ÉCHAPPEMENT MÉTALLIQUE, NOIR (INC AT173 - AT171)	32,50 €
AT173	JUNTA TÓRICA VITON 2,62 X 31,42 MM (SET DE 2) O-RING VITON 2,62 X 31,42 MM (SET OF 2) JOINT TORIQUE VITON 2,62 X 31,42 MM (SET DE 2)	5,00 €
AT174	ESPÁRRAGOS DE ESCAPE (SET OF 2) EXHAUST STUD (SET OF 2) GOUJONS D'ÉCHAPPEMENT (SET DE 2)	11,88 €
AT175	MUELLE DE COMPRESION DE ESCAPE (SET OF 2) EXHAUST COMPRESSION SPRING (SET OF 2) RESSORT DE COMPRESSION D'ÉCHAPPEMENT (SET OF 2)	5,00 €
AT180a	ESCAPE CROMADO, PARTE INICIAL CHROMED EXHAUST, INITIAL PART ECHAPEMENT CHROMÉ, PARTIE INITIAL	95,00 €
AT180b	ESCAPE CROMADO, PARTE FINAL CHROMED EXHAUST, FINAL PART ECHAPEMENT CHROMÉ, PARTIE FINAL	98,75 €
AT182	ALUMINUM SILENCER PIPE, BLACK ALUMINUM SILENCER PIPE, BLACK ALUMINUM SILENCER PIPE, BLACK	100,00 €
AT183	CONICAL WIRE MESH CONICAL WIRE MESH CONICAL WIRE MESH	19,38 €

AT184	SET OF 2 NOISE ABSORBENT MATERIAL SET OF 2 NOISE ABSORBENT MATERIAL SET OF 2 NOISE ABSORBENT MATERIAL	21,25 €
AT185	CHROMED SILENCER CAP CHROMED SILENCER CAP CHROMED SILENCER CAP	86,25 €
AT186	PLACA SOPORTE ESCAPE EN ERGAL, NEGRO EXHAUST SUPPORT PLATE IN ERGAL, BLACK PLAQUE DE SUPPORT D'ÉCHAPPEMENT EN ERGAL, NOIR	28,75 €
AT187	TORNILLO 6 X 16 TCEI DIN 912 (SET DE 3) BOLT 6 X 16 TCEI DIN 912 (SET OF 3) VIS 6 X 16 TCEI DIN 912 (SET DE 3)	0,94 €
VM019	TUERCA DE COBRE AUTOBLOCANTE DE ALTA TEMPERATURA 8 X 1,25 MM (SET DE 4) COPPER LOCK NUT HIGH TEMPERATURE 8 X 1,25 MM (SET OF 4) ECROUS DE CUIVRE AUTO BLOQUANT HAUT TEMPÉRATURE 8 X 1,25 MM (SET DE 4)	5,00 €
VM139	EXHAUST SPRING (SET OF 4) EXHAUST SPRING (SET OF 4) EXHAUST SPRING (SET OF 4)	10,00 €
VM151c	SILENTBLOCK 30 X 20 MM HARD (RIGHT) 14/14 MM (SET DE 2) (INCL M018 - M019) ANTIVIBRATION MOUNT 30 X 20 MM HARD (RIGHT) 14/14 MM (SET OF 2) (INCL M018 - M019) SILENTBLOCK 30 X 20 MM HARD (RIGHT) 14/14 MM (SET DE 2) (INCL M018 - M019)	11,25 €
VMP047a	TUERCA AUTOBLOCANTE 6MA DIN 980 (SET DE 4) LOCK NUT 6MA DIN 980 (SET OF 4) ÉCROU AUTOBLOQUANT 6MA DIN 980 (SET DE 4)	1,25 €
VMP140	HEAT SHRINKABLE TUBING (SET OF 4) HEAT SHRINKABLE TUBING (SET OF 4) HEAT SHRINKABLE TUBING (SET OF 4)	2,50 €
VMP141	SECURITY CABLES 37 CM WITH ALUMINUM CLAMPS (SET OF 3) SECURITY CABLES 37 CM WITH ALUMINUM CLAMPS (SET OF 3) SECURITY CABLES 37 CM WITH ALUMINUM CLAMPS (SET OF 3)	3,75 €
VMP161	REMACHE INOX Ø 5 MM (SET DE 10) INOX RIVET Ø 5 MM (SET OF 10) INOX RIVET Ø 5 MM (SET DE 10)	6,25 €

	R0002	COJINETE CIGÜEÑAL (6204 C3 TN9) CRANKSHAFT BEARING (6204 C3 TN9) ROULEMENT VILEBREQUIN (6204 C3 TN9)	9,80 €
	R0003	RETÉN MOTOR (20-32-7) ENGINE SEAL (20-32-7) JOINT SPY MOTEUR (20-32-7)	9,31 €
	R0004	PRISIONERO CILINDRO CYLINDER PRISONER GOUJON DE CYLINDRE	6,00 €
	R0007	CIGÜEÑAL CRANKSHAFT VILEBREQUIN	282,10 €
	R0009	RODAMIENTO DE AGUJA PISTON BALLBEARING ROULEMENT DE PISTON	11,25 €
	R0012	PISTON COMPLETO (SEGMENTO Y BULON) - ROS125 PISTON COMPLETE (SEGMENT & BOULON) - ROS125 PISTON COMPLET (SEGMENT ET BOULON) - ROS125	98,00 €
	R0013	SEGMENTO SEGMENT SEGMENT	11,14 €
	R0014	CILINDRO ROS125 CYLINDER ROS125 CYLINDRE ROS125	655,76 €
	CIL0008	CILINDRO y PISTON MOTOR PAP para ROS125 PAP MOTOR CYLINDER and PISTON for ROS125 CYLINDRE et PISTON MOTEUR PAP pour ROS125	350,00 €
	R0015	JUNTA BASE CILINDRO CYLINDER GASKET JOINT DE CYLINDRE	2,12 €
	R0017R	CULATA ROS125 HEAD CYLINDER ROS125 CULASSE ROS125	95,70 €
	R0018	JUNTA CULATA HEAD CYLINDER GASKET JOINT DE CULASSE	4,00 €
	R0032LT	TAPA CILINDRO CYLINDER COVER COUVERCLE DE CYLINDRE	75,50 €
	R0141	DECOMPRESOR CILINDRO CYLINDER DEPRESSION DEPRESSION CYLINDRE	15,90 €
	R0035LT	VOLANTE MAGNETICO (TAMBIEN VENTILADOR) FLYWHEEL (COOLING FAN) VOLANT MAGNETIQUE (VENTILATEUR)	153,64 €
	R0104	SILENTBLOCK MOTOR (H30-25 M8 65°) ENGINE ANTIVIBE (H30-25 M8 65°) SILENTBLOCK MOTEUR (H30-25 M8 65°)	3,75 €









	R0052	EMBRAGUE CLUTCH EMBAYAGE	129,10 €
	R0054	CAMPANA CLUTCH BELL CLOCHE	69,65 €
	R0056	COJINETE REDUCTORA BAJO (6003 2RSR) LOW REDUCTION BEARING (6003 2RSR) ROULEMENT BAS REDUCTEUR (6003 2RSR)	6,50 €
	R0057	RETÉN REDUCTORA BAJA (20-30-5) LOW REDUCTION SEALER (20-30-5) JOINT SPY (BAS) REDUCTEUR (20-30-5)	9,75 €
	R0058	CARTER REDUCTORA GEARBOX CRANKCASE CARTER REDUCTEUR	175,00 €
	R0060	PIÑÓN BAJO REDUCTOR REDUCTOR LOW PINION PIGNON BAS REDUCTEUR	78,20 €
	R0061	CORONA REDUCTORA + EJE PIÑÓN ALTO REDUCTOR COGWHEEL + HIGH PINION STUD COURONNE REDUCTEUR + AXE PIGNION HAUT	141,78 €
	R0061S	CORONA REDUCTORA REDUCTOR COGWHEEL COURONNE REDUCTEUR	112,00 €
	R0061P	EJE PIÑÓN ALTO HIGH PINION STUD AXE PIGNION HAUT	46,87 €
	R0065	COJINETE REDUCTORA ALTO (6004) HIGH REDUCTOR BEARING (6004) ROULEMENT HAUT REDUCTEUR (6004)	6,50 €
	R0066	TAPA REDUCTORA REDUCTOR COVER COUVERCLE REDUCTEUR	85,00 €
	R0066G	JUNTA REDUCTORA REDUCTOR GASKET JOINT REDUCTEUR	8,50€
	R0068	RETÉN REDUCTORA ALTO (25-35-7) HIGH REDUCTOR SEALER (25-35-7) JOINT SPY (HAUT) REDUCTEUR (25-35-7)	10,62 €
	R0086	REDUCTORA COMPLETA COMPLETE REDUCTOR REDUCTEUR COMPLET	638,39 €
	R0070	CASQUILLO HÉLICE PROPELLER CASE DOUILLE HÉLICE	6,10 €
	R0071	SOPORTE HELICE PROPELLER PLATE SUPPORT HELICE	42,30 €
	R0071F	CONTRA PLACA HELICE PROPELLER FLANGE CONTRE PLAQUE HELICE	20,87 €
	R0072	TORNILLO-CENTRAL CENTRAL SCREW VIS-CENTRALE	1,00 €
	R0135	VÁLVULA VALVE VALVE	6,68 €
	R0069	JUNTA TÓRICA EJE DE HÉLICE (VITON) PROPELLER SHAFT GASKET (VITON) JOINT TORIQUE AXE HELICE (VITON)	2,87 €
	R0088	EJE ZAPATA EMBRAGUE CLUTCH SHOE SHAFT AXE MACHOIRE D'EMBAYAGE	3,00 €

PAP

ROS125

REDUCTORA
REDUCTOR
RÉDUCTEURpage
2/2



PVP

	R0087	CLIP (EJE ZAPATA EMBRAGUE) Anillo seeger. CLIP (CLUCTH SHOE SHAFT) Seeger. CLIP (AXE MACHOIRE D'EMBRAYAGUE) Anneaux seeger.	0,44 €
	R0089	ARANDELA (EJE ZAPATA EMBRAGUE) WASHER (CLUCTH SHOE SHAFT) RONDELLE (AXE MACHOIRE D'EMBRAYAGUE)	0,65 €
	R0026	MUELLE (ZAPATA EMBRAGUE) SPRING (SHOE SHAFT) RESSORT (MACHOIRE D'EMBRAYAGUE)	2,65 €
	R0027	TORNILLO (MUELLE ZAPATA EMBRAGUE) SCREW (SPRING SHOE SHAFT) VIS (RESSORT MACHOIRE D'EMBRAYAGUE)	1,50 €
	R0055	CLIP REDUCTORA BAJO (Anillo seger 35mm) LOW REDUCTOR RING / CLIP (Seger Ring 35mm) CLIP REDUCTEUR BAS (Anneaux seger 35mm)	1,70 €
	R0067	CLIP REDUCTORA ALTO (Anillo seger 40mm) HIGH REDUCTOR RING / CLIP (Seger Ring 40mm) CLIP REDUCTEUR HAUT (Anneaux seger 40mm)	3,05 €
	H6440	KIT TORNILLOS HELICE M6 X 40mm. 4 Unidades KIT SCREW M6 X 40 mm. PROPELLER. 4 Unities KIT VIS HELICE M6 X 40 mm. 4 Unitées	2,00 €
	H6450	KIT TORNILLOS HELICE M6 X 50mm. 4 Unidades KIT SCREW M6 X 50 mm. PROPELLER. 4 Unities KIT VIS HELICE M6 X 50 mm. 4 Unitées	2,00 €









ROS125

TUBO ESCAPE
EXHAUST PIPE
TUBE D'ÉCHAPPEMENTpage
1/2

PVP

	R0111	JUNTA LATON DE ESCAPE EXHAUST MANIFOLD GASKET JOINT LATION D'ÉCHAPPÉMENT	3,90 €
	R0093	SILENTBLOCK ESCAPE (unidad) 30 x 20 55° M8X20 EXHAUST SILENTBLOCK (unit) 30 x 20 55° M8X20 SILENTBLOCK ECHAPPEMENT (unite) 30 x 20 55° M8X20	3,75 €
	R0105	SILENTBLOC SILENCIADOR (unidad) 30 x 15 60° M8 MUFFLER SILENTBLOC (unit) 30 x 15 60° M8 SILENTBLOC SILENCIEUX (unite) 30 x 15 60° M8	3,75 €

TUBO ESCAPE PAP PARA ROS125 · PAP EXHAUST PIPE FOR ROS125 · POT D'ÉCHAPPEMENT PAP POUR ROS125

	PA334KR	KIT ESCAPE COMPLETO PAP PARA ROS125 (PA334, PA301, PA321, RP306K) COMPLETE PAP EXHAUST KIT FOR ROS125 (PA334, PA301, PA321, RP306K) POT D'ÉCHAPPEMENT COMPLET PAP POUR ROS125 (PA334, PA301, PA321, RP306K)	325,00 €
	PA335KR	ESCAPE SIN SILENCIADOR PAP PARA ROS125 PAP EXHAUST WITHOUT SILENCER FOR ROS125 POT D'ÉCHAPPEMENT SANS SILENCIEUX PAP POUR ROS125	206,25 €
	RP314KR	SILENCIOSO COMPLETO PAP PARA ROS125 COMPLETE PAP SILENCER FOR ROS125 SILENCIEUX COMPLET PAP POUR ROS125	180,75 €
	PA301	ROTULA - PA125 ROTULAR CONNECTION - PA125 ROTULE - PA125	22,50 €
	PA321	JUNTA ESCAPE - PA125 EXHAUST GASKET - PA125 JOINT D'ÉCHAPPEMENT - PA125	3,00 €
	RP306K	KIT SUJECCION ROTULA - ESCAPE (3 UNIDADES) RP306 + RP302 + RP307 + RP313 ROTULAR - EXHAUST JOINT KIT (3 UNITS) RP306 + RP302 + RP6307 + RP313 KIT FIXATION ROTULAIRE - TUBE D'ÉCHAPPEMENT (3 UNITÉS) RE306 + RP302 + RP307 + RP313	8,12 €
	RP315	GOMA DE UNION SILENCIADOR UNION RUBBER FOR MUFFLER GOMME UNION SILENCIEUX	12,00 €
	RP321	JUNTAS TORICAS ESCAPE (VITON) (2 UNIDADES) EXHAUST GASKET (VITON) (2 UNITIES) JOINT TORIQUE (VITON) (2 UNITÉES)	8,90 €

	RP309	TORNILLOS DE SUJECION DE LA ROTULA - CILINDRO (2 UDS.) ROTULAR - CILINDER JOINT SCREWS (2 UDS.) VIS DE L'ARTICULATION ROTULAIRE - CILINDRE (2 UDS.)	1,50 €
	RP328	TUERCAS AUTO BLOCANTES KIT ABRAZADERA M8 BRACE MOUNTING KIT LOCK NUT M8 ECROUS AUTOBLOQUANT KIT MONTAGE COLLIER SILENCIEUX M8	0,50 €
	RP329	ARANDELA ANCHA ESCAPE / CARTER M8 LARGE WASHER CARTER/EXHAUST M8 RONDELLES LARGE ÉCHAPPEMENT / CARTER M8	0,37 €
	RP302	MUELLE ESCAPE SPRINGS FOR EXHAUST SYS RESSORTS SYS. D'ÉCHAPPEMENT	1,50 €
	RP307	TUERCAS M6 AUTOBLOQUANTES DE ROTULA ESCAPE (TORNILLO RP306) (3 UNIDADES) LOCK NUT TO HOLD THE EXHAUST BALL JOINT M6 (SCREW RP306) (3 UNITS) ECROU M6 AUTOBLOQUANT DE MAINTIEN DE LA ROTULE (VIS RP306) (3 UNITÉS)	1,50 €
	RP306	TORNILLOS DE SUJECION ROTULA - ESCAPE M6X50 (3 UNIDADES) ROTULAR - EXHAUST JOINT SCREWS M6X50 (3 UNITS) VIS DE L'ARTICULATION ROTULAIRE - TUBE D'ÉCHAPPEMENT M6X50 (3 UNITÉS)	2,25 €
	RP323	CABLE DE SEGURIDAD DEL SILENCIADOR DEL ESCAPE + 2 CIERRES SEGURIDAD CABLE SECURITY CABLE OF THE EXHAUST SILENCER + 2 SOLDERESS NIPPLE FOR CABLE CÂBLE DE SÉCURITÉ DU SILENCIEUX DE L'ÉCHAPPEMENT + 2 COLLIER CABLE DE SÉCURITÉ	2,00 €
	A58	CIERRE SEGURIDAD CABLE (SILENCIADOR DEL ESCAPE) SOLDERESS NIPPLE FOR CABLE (EXHAUST SILENCER) COLLIER CABLE DE SÉCURITÉ (SILENCIEUX DE L'ÉCHAPPEMENT)	0,50 €
	RP331	SILENTBLOC ABRAZADERA DEL SILENCIOSO (30 x 15 60° M8) SILENCER METAL BRACE SILENTBLOC (30 x 15 60° M8) SILENTBLOC COLLIER POUR SILENCIEUX (30 x 15 60° M8)	3,75 €
	RP308	SILENTBLOCK M8 30X30MM (ESCAPE) SILENTBLOCK M8 30X30MM (EXHAUST) SILENTBLOCK M8 30X30MM (ÉCHAPPEMENT)	3,75 €
	RP316	ABRAZADERA DEL SILENCIOSO SILENCER METAL BRACE COLLIER POUR SILENCIEUX	7,50 €
	RP317	GOMA DE ABRAZADERA SILENCER BRACE RUBBER BAND LANGUETTE CAOUTCHOUC POUR COLLIER	4,50 €
	RP330	TORNILLO M8 KIT ABRAZADERA M8 SCREW BRASE MOUNTING KIT VIS M8 KIT MONTAGE COLLIER SILENCIEUX	0,87 €
	RP318	KIT ABRAZADERA DEL SILENCIOSO SILENCER METAL BRACE KIT KIT COLLIER POUR SILENCIEUX	16,25 €
	RP320	FIBRA SILENCIADOR SILENCER FIBER FIBRE SILENCIEUX	10,50 €
	RP325	JUNTA DE SILENCIOSO SILENCER PAPER GASKET JOINT DE SILENCIEUX	1,50 €

	R0043LT	ARRANQUE MANUAL COMPLETO ORIGINAL ROS ROS ORIGINAL COMPLETE MANUAL STARTER DEMARREUR MANUEL COMPLET ORIGINAL ROS	70,00 €
	R0043PLT	POLEA DE ARRANQUE MANUAL ORIGINAL ROS ROS ORIGINAL PLASTIC MANUAL STARTER PULLEY POULIE DEMARREUR MANUEL ORIGINAL ROS	16,37 €
	R0043MT	MUELLE POLEA ARRANQUE STARTER PULLEY SPRING RESSORT POULIE DÉMARREUR	7,50 €
	R0073LT	CARTER ARRANQUE MANUAL MANUAL STARTER CARTER CARTER DEMARREUR MANUEL	80,47 €
	R0140	CUERDA DE ARRANQUE 140cms STARTER ROPE, 140 cms CORDE DU DEMARREUR 140cms	1,50 €
	R0035CR	KIT CLIQUET (1 CLIQUET, 1 MUELLE, 1 EJE) CLIQUET, SPRING AND STUD SET KIT DEMARREUR (1 CLIQUET, 1 RESSORT, 1 AXE)	11,00 €
	R0040	MUELLE CLIQUET CLIQUET SPRING (STARTER) RESSORT CLIQUET	3,12 €
	R0041	EJE CLIQUET CLIQUET STUD (STARTER) AXE CLIQUET	5,00 €
	R0042	CLIQUET CLIQUET CLIQUET	3,75 €
	R0036LT	BOBINA COIL BOBINE	75,20 €
	R0036LTB	BUJIA NGK B10ES SPARK PLUG NGK B10ES BOUGIE NGK B10ES	3,75 €

	R0047	CAJA DE LAMINAS REED VALVE SHEETS BOITE A CLAPETS	62,00 €
	R0048L	JUNTA CAJA LAMINA REED VALVE GASKET JOINT BOITE A CLAPET	4,00 €
	R0048F	JUNTA PLACA CARBURADOR (CAJA DE LAMINA) CARBURETTOR FLANGE GASKET (REED VALVE) JOINT PLAQUE CARBURATEUR (BOITE A CLAPETS)	4,00 €
	R0051	JUNTA CARBURADOR CARBURETTOR GASKET JOINT CARBURATEUR	1,50 €
	C006R	CARBURADOR WALBRO 24 (ROS125) WALBRO 24 CARBURETTOR (ROS125) CARBURATEUR WALBRO24 (ROS125)	175,00 €
	R0047L	LAMINA (1 Unidad) REED VALVE SHEET (1 Unities) LAMELLE (1 Unitées)	9,10 €
	R0049	SOPORTE DEL CARBURADOR CARBURETTOR SUPPORT SUPPORT CARBURATEUR	35,00 €
	RF263	SOPORTE DEL SILENCIADOR DE ADMISIÓN AIRBOX SUPPORT SILENCIEUX D'ADMISSION (Airbox) SUPPORT	10,00 €
	R0082	SILENCIADOR ADMISIÓN (Airbox) AIRBOX SILENCIEUX D'ADMISSION (Airbox)	75,00 €
	R0082G	GOMA DE UNION CARBURADORAR - FILTRO DE AIRE (AIBOX) CARBURETTOR - AIRBOX RUBBER JONCTION GOMME UNION CARBURATEUR - AIRBOX	7,50 €

PA125

BLOQUE MOTOR MOTOR BLOCK BLOQUE MOTEUR

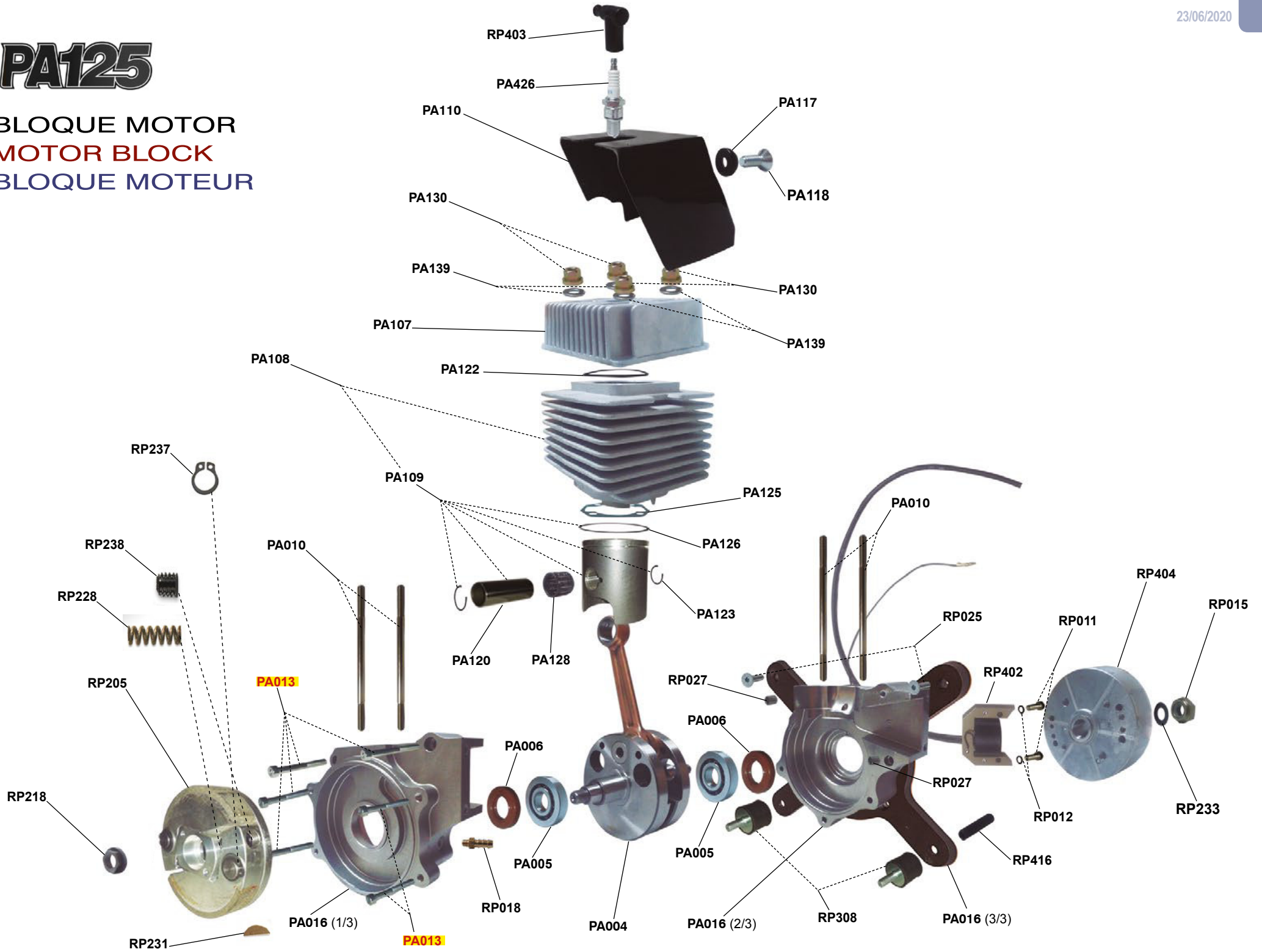

RM80 & PA125

REDUCTORA
REDUCTOR
REDUCTEUR

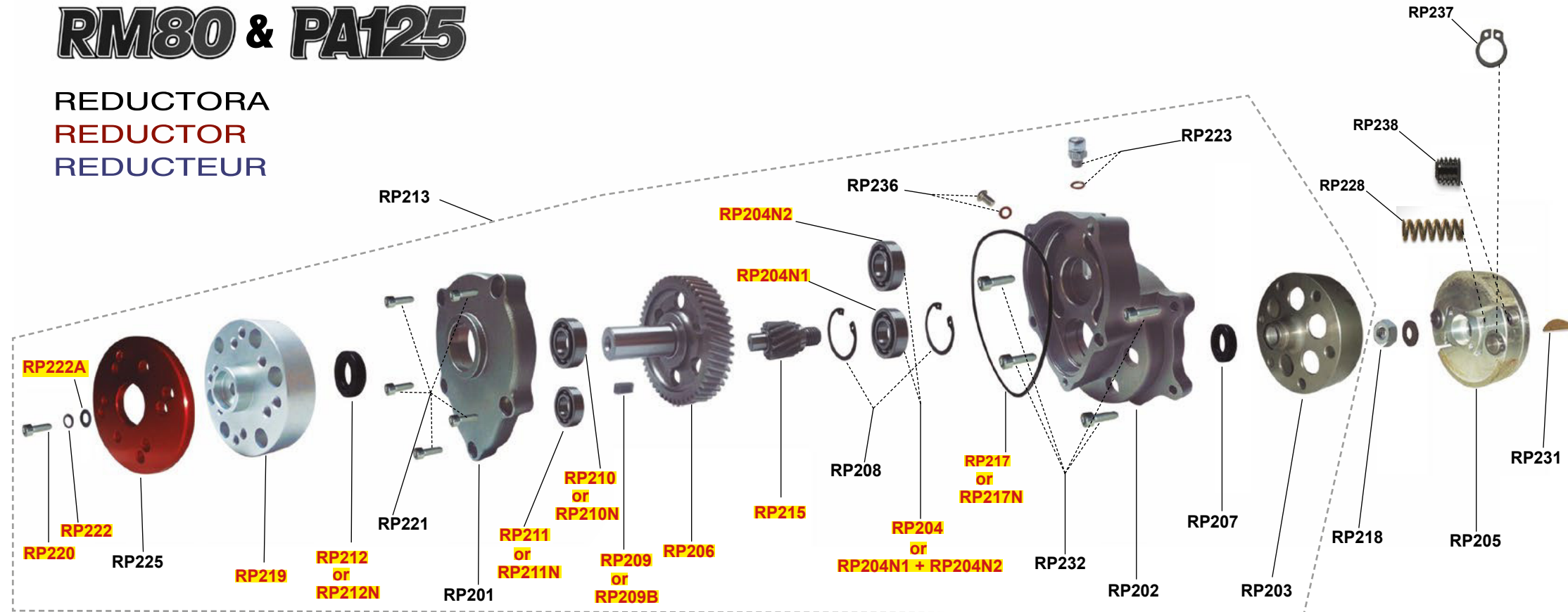

	REFERENCE	OLD MODEL	NEW MODEL
*	RP220	M8	* M6
*	RP222	Ø 8	* Ø 6
*	RP222A	Ø 8	* Ø 6
*	RP219	For 17 mm. shaft	* For 20 mm. shaft
	RP212	17 - 30 - 7	-
*	RP212N	-	20 - 30 - 6/7
	RP211	6000	-
	RP211N	-	6200
	RP210	6002 C3	-
*	RP210N	-	6204 C3

	REFERENCE	OLD MODEL	NEW MODEL
*	RP209	For 17 mm. shaft	-
	RP209B	-	For 20 mm. shaft
*	RP206	Shaft 17 mm.	Shaft 20 mm.
	RP204	6003	-
	RP204N1	-	6003
	RP204N2	-	6202
	RP217	Ø 90 mm.	-
	RP217N	-	Ø 96 mm.

	REFERENCE	red. 3.65 (standar)	red. 3.1
*	RP215	14 pinion	16 pinion-
*	RP206	51 pinion-	

*
RP206EK
RP220 + RP222 + RP222A + RP219 + RP212N + RP210N + RP209 + RP206
KIT ACTUALIZACION EJE ø20 ø20 SHAFT UPDATE KIT KIT ACTUALISATION AXE ø20
PVP. 92,57 €

RM80

ESCAPE EXHAUST PIPE ECHAPPEMENT



RP314

RM335SN

RP306

RP302

RP307

RP304

RP309

RM303

RM119

RP321

RP329

RP328

RP328

RP331

RP315

RP320

RP316

RP317

RP329

RP327

RP330

PA125

ESCAPE EXHAUST PIPE ECHAPPEMENT



RM80 & PA125

ARRANQUE STARTER DEMARREUR

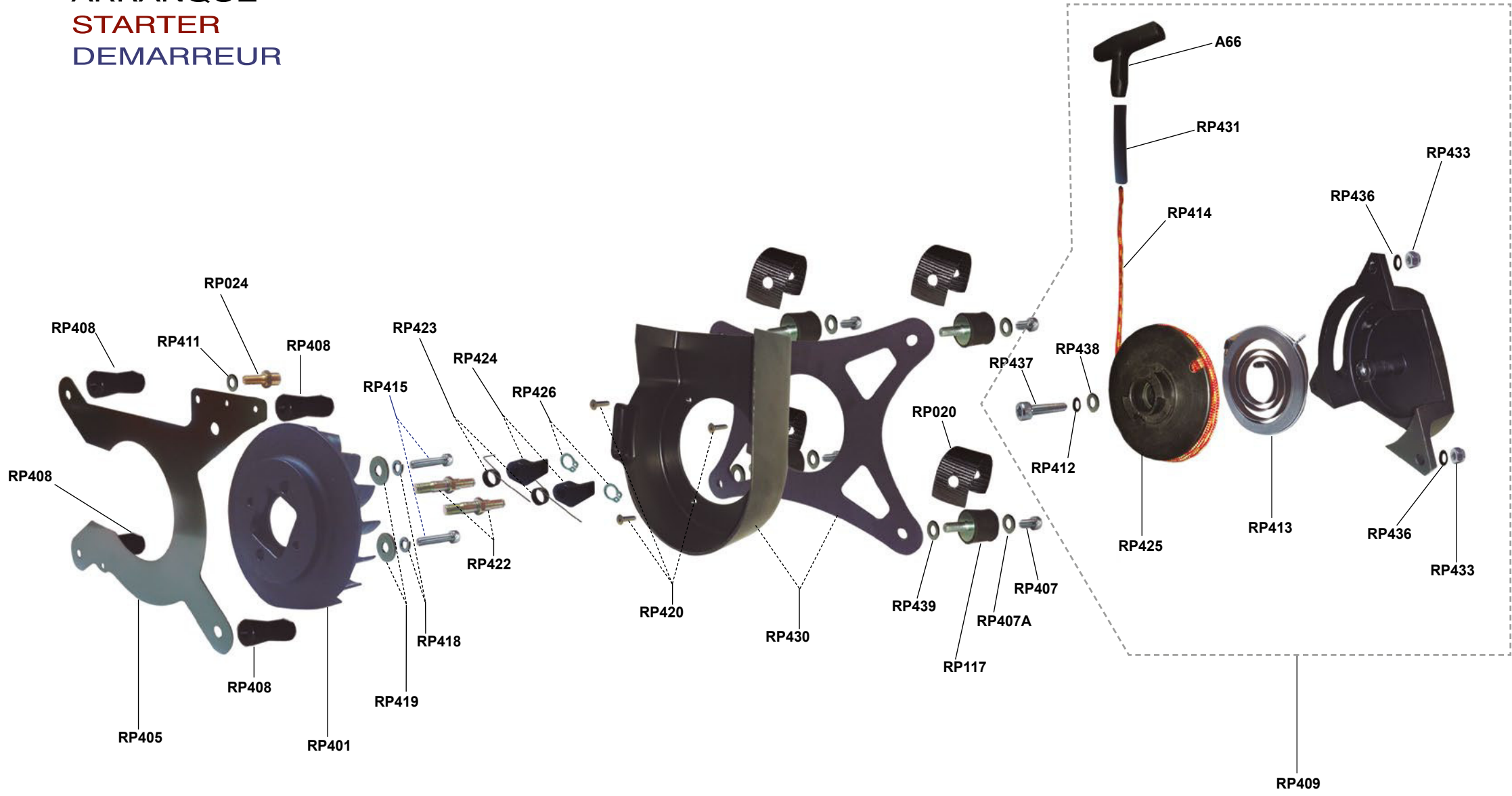

RM80 & PA125

ADMISION
ADMISSION
ADMISSION

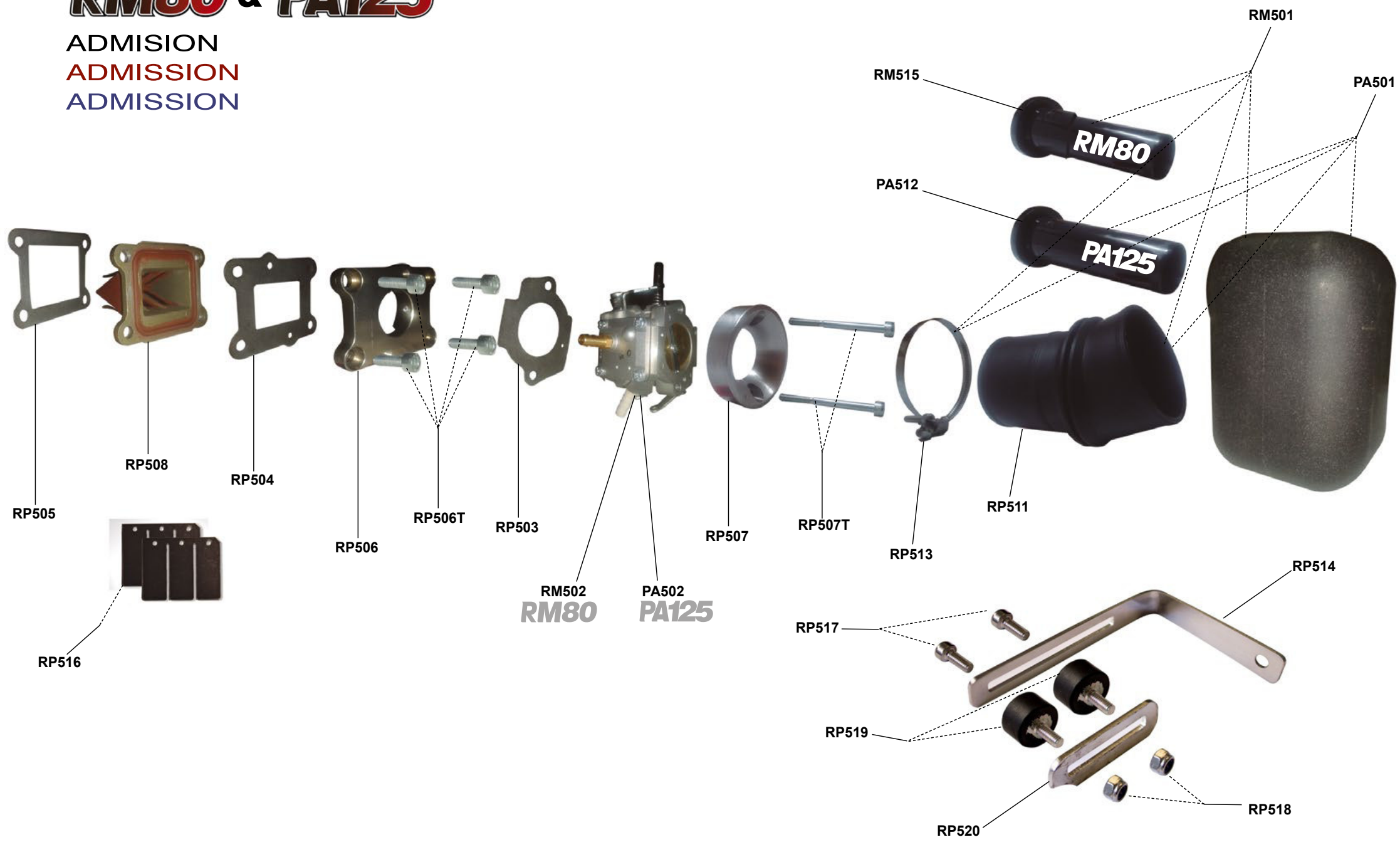

	RP403	PIPA DE BUJIA SPARK PLUG CAP CAPUCHON DE BOUGIE	13,75 €
	RP404	PLATO MAGNÉTICO MAGNETIC PLATE PLATEAU MANGÉTIQUE	39,00 €
	RP015	TUERCA M10 AUTOBLOCANTE (PLATO MAGNÉTICO) NUT M10 AUTOBLOCANTE (MAGNETIC PLATE) ECROU M10 AUTOBLOCANTE (PLATEAU MANGÉTIQUE)	1,50 €
	RP011	TORNILLOS DE BOBINA M5 (2 UNIDADES) COIL SCREWS M5 (2 UNITIES) VIS DE BOBINE M5 (2 UNITÉES)	1,50 €
	RP012	ARANDELAS M5 (2 UNIDADES) (TORNILLOS DE BOBINA RP011) WASHERS M5 (2 UNITIES) (COIL SCREWS RP011) RONDELLES M5 (2 UNITÉES) (VIS DE BOBINE RP011)	0,62 €
	RP402	BOBINA COIL BOBINE	48,75 €
	RP233	ARANDELA PLATO MAGNÉTICO MAGNETIC PLATE WASHER RONDELLE PLATEAU MANGÉTIQUE	0,50 €
	RP218	TUERCA SUJECION EMBRAGUE M10 CLUTCH HOLDING NUT M10 ECROU DE FIXATION EMBRAYAGE M10	2,87 €
	RP231	CHAVETA EMBRAGUE CLUTCH COTTER PIN CLAVETTE DE EMBRAYAGE	2,50 €
	RP205	EMBRAGUE CLUTCH EMBAYAGE	75,00 €
	RP237	CLIP (EJE ZAPATA EMBRAGUE) ANILLO SEEGER. CLIP (CLUTCH SHOE SHAFT) SEEGER. CLIP (AXE MACHOIRE D'EMBAYAGE) ANNEAUX SEEGER.	0,75 €
	RP228	MUELLE (ZAPATA EMBRAGUE) SPRING (SHOE SHAFT) RESSORT (MACHOIRE D'EMBAYAGE)	3,37 €
	RP238	TORNILLO (MUELLE ZAPATA EMBRAGUE) SCREW (CLUTCH SHOE SPRING) VIS (RESSORT MACHOIRE D'EMBAYAGE)	0,62 €
	RP018	DEPRESION CARTER MOTOR CARTER DEPRESSION EXIT DEPRESSION CARTER MOTEUR	1,80 €
	RP027	FIJAS DE 8MM (2 UNIDADES) GUIDING BRACE OF 8MM (2 UNITIES) ENTRETOISE DE 8MM (2 UNITÉES)	3,00 €
	RP025	TORNILLOS PARA SOPORTE (2 UNIDADES) SUPPORT SCREWS (2 UNITÉES) VIS POUR SUPPORT (2 UNITIES)	1,50 €
	RP416	ESPARRAGOS DE ENCENDIDO (2 UNIDADES) PULL START SYSTEM STUDS (2 UNITIES) TIGE D'ENTRAINEMENT DÉMARREUR (2 UNITÉES)	1,00 €
	RP117	SILENTBLOCK M8 30X25MM (MOTOR) SILENTBLOCK M8 30X25MM (MOTOR) SILENTBLOCK M8 30X25MM (MOTEUR)	3,75 €
	RP308	SILENTBLOCK M8 30X30MM (ESCAPE) SILENTBLOCK M8 30X30MM (EXHAUST) SILENTBLOCK M8 30X30MM (ECHAPPEMENT)	3,75 €

RM80

BLOQUE MOTOR
MOTOR BLOCK
BLOQUE MOTEUR

page
2/4

PVP



	RM427	BUJIA BR9ES - RM80 SPARK PLUG BR9ES - RM80 BOUGIE BR9ES - RM80	4,00 €
	RM113	TUERCAS DE TAPA DE CULATA M6 - RM80 (2 UNIDADES) CILINDER VENT COVER NUTS M6 - RM80 (2 UNITIES) ECROUS DE COUVERCLE DE VENT M6 - RM80 (2 UNITÉES)	2,50 €
	RM140	ARANDELAS DE TAPA DE CILINDRO - RM80 (2 UNIDADES) WASHERS CYLINDER COVER - RM80 (2 UNITIES) RONDELLES DE COUVERCLE CILINDRE - RM80 (2 UNITÉES)	1,90 €
	RM105	TAPA CILINDRO - RM80 CYLINDER COVER - RM80 COUVERCLE CILINDRE - RM80	41,00 €
	RM114	SEPARADORES (CULATA - TAPA CILINDRO) - RM80 (2 UNIDADES) SPACERS (CYLINDER COVER - CILINDER HEAD) - RM80 (2 UNITIES) SÉPARATEURS (CULASSE - COUVERCLE CILINDRE) - RM80 (2 UNITÉES)	1,00 €
	RM115	ARANDELAS DE TAPA DE CILINDRO - RM80 (2 UNIDADES) WASHERS FOR CYLINDER COVER - RM80 (2 UNITIES) RONDELLES DE COUVERCLE DE VENT - RM80 (2 UNITÉES)	1,00 €
	RM112	TUERCA DE CULATA - RM80 CYLINDER HEAD NUT - RM80 ECROU DE CULASSE - RM80	3,75 €
	RM103	CULATA - RM80 CYLINDER HEAD - RM80 CULASSE - RM80	57,00 €
	RM104	JUNTA TORICA DE CULATA - RM80 CYLINDER HEAD GASKET - RM80 JOINT TORRIQUE DE CULASSE - RM80	2,50 €
	RM101	CILINDRO + PISTON - RM80 CYLINDER + PISTON - RM80 CILINDRE + PISTON - RM80	156,25 €
	RM121	JUNTA CILINDRO - RM80 CYLINDER GASKET - RM80 JOINT D'EMBASE - RM80	1,25 €
	RM102	PISTON COMPLETO (SEGMENTO Y BULON) - RM80 *Especifique la serie del piston (SERIE A, B, C...) PISTON COMPLETE (SEGMENT & BOULON) - RM80 *Specify serial of piston (SERIE A, B, C...) PISTON COMPLET (SEGMENT ET BOULON) - RM80 *Specifiez la serie du piston (SERIE A, B, C...)	47,50 €
	RM111	SEGMENTO - RM80 PISTON RING - RM80 SEGMENT - RM80	17,19 €
	RM127	RODAMIENTO PISTON - RM80 PISTON BEARING - RM80 ROULEMENT PISTON - RM80	11,25 €
	RM116	BULON DE PISTON - RM80 PISTON BOLT - RM80 BOULON DE PISTON - RM80	9,00 €
	RM124	CLIPS DEL BOULON - RM80 (2 UNIDADES) BOULON CLIPS - RM80 (2 UNITIES) CLIPS DE BOULONS - RM80 (2 UNITÉES)	5,00 €
	RM007	RETEN CIGÜEÑAL - RM80 (18-28-7) CRANKSHAFT SEAL - RM80 (18-28-7) JOINT SPI VILEBREQUIN - RM80 (18-28-7)	6,30 €
	RM007N	RETEN CIGÜEÑAL - RM80 (18-30-7) CRANKSHAFT SEAL - RM80 (18-30-7) JOINT SPI VILEBREQUIN - RM80 (18-30-7)	6,30 €
	RM001	CIGUEÑAL CON BIELA - RM80 CRANKSHAFT - RM80 VILEBREQUIN AVEC BIELLE - RM80	262,50 €
	RM005	RODAMIENTO CIGUEÑAL - RM80 (3055) CRANKSHAFT BEARING - RM80 (3055) ROULEMENT VILEBREQUIN - RM80 (3055)	22,50 €
	RM002	ESPARRAGOS LARGOS (CILINDRO-CULATA-CARTER) - RM80 (2 UNIDADES) LONG STUDS (CILINDER-HEAD CILINDER-CARTER) - RM80 (2 UNITIES) AXES LONGUES (CYLINDRE-CULASSE-CARTER) - RM80 (2 UNITÉES)	5,00 €

RM80

BLOQUE MOTOR
MOTOR BLOCK
BLOQUE MOTEUR

 page
3/4

PVP

	RM003	ESPARRAGOS CORTOS (CILINDRO-CULATA-CARTER) - RM80 (2 UNIDADES) SHORT STUDS (CILINDER-HEAD CILINDER-CARTER) - RM80 (2 UNITIES) AXES COURTES (CYLINDRE-CULASSE-CARTER) - RM80 (2 UNITÉES)	5,00 €
	RM008	CARTER RM80 (DELANTERO + TRASERO + SOPORTE) CRANKSHAFT CARTER - RM80 (FRONT + BACK + SUPPORT) CARTER RM80 (AVANT + ARRIERE + SUPPORT)	401,25 €

PA125

BLOQUE MOTOR
MOTOR BLOCK
BLOQUE MOTEUR

 page
3/4

PVP



	PA426	BUJIA BR10ES - PA125 SPARK PLUG BR10ES - PA125 BOUGIE BR10ES - PA125	3,75 €
	PA110	TAPA CILINDRO - PA125 CYLINDER COVER - PA125 COUVERCLE CILINDRE - PA125	50,00 €
	PA130	TUERCA DE CULATA - PA125 CYLINDER HEAD NUT - PA125 ECROU DE CULASSE - PA125	3,75 €
	PA139	ARANDELAS M8 DE CULATA - PA125 (4 UNIDADES) RONDELLES M8 DE CULASSE - PA125 (4 UNITS) M8 WASHER FOR CYLINDER HEAD - PA125 (4 UNITÉS)	0,50 €
	PA117	ARANDELA DE TAPA DE CILINDRO PA125 WASHER CYLINDER COVER PA125 RONDELLE DE COUVERCLE CILINDRE PA125	0,75 €
	PA118	TORNILLO M8 DE SUJECCION DE TAPA CILINDRO PA125 CYLINDER HEAD COVER HOLDING SCREW M8 - PA125 VIS M8 POUR FIXER LE COUVERCLE DE CILINDRE - PA125	1,00 €
	PA107	CULATA - PA125 CILINDER HEAD - PA125 CULASSE - PA125	72,50 €
	PA122	JUNTA TORICA DE CULATA - PA125 HEAD CYLINDER GASKET - PA125 JOINT TORIQUE DE CULASSE - PA125	4,00 €
	PA108	CILINDRO Y PISTON - PA125 CYLINDER & PISTON - PA125 CILINDRE ET PISTON - PA125	312,50 €
	PA125	JUNTA CILINDRO - PA125 CYLINDER GASKET - PA125 JOINT CILINDRE - PA125	2,10 €
	PA109	PISTON COMPLETO (SEGMENTO Y BULON) - PA125 PISTON COMPLETE (SEGMENT & BOULON) - PA125 PISTON COMPLET (SEGMENT ET BOULON) - PA125	98,00 €
	PA126	SEGMENTO - PA125 PISTON RING - PA125 SEGMENT - PA125	13,75 €
	PA123	CLIPS DE BULON - PA125 (2 UNIDADES) BOULON CLIPS - PA125 (2 UNITIES) CLIPS DE BOULONS - PA125 (2 UNITÉES)	9,00 €
	PA120	BULON DE PISTON - PA125 PISTON BOULON - PA125 AXE DE PISTON - PA125	11,00 €
	PA128	RODAMIENTO PISTON - PA125 PISTON BEARING - PA125 ROULEMENT PISTON - PA125	11,25 €
	PA010	ESPARRAGOS (CILINDRO-CULATA-CARTER) - PA125 (4 UNIDADES) STUDS (CILINDER-HEAD CILINDER-CARTER) - PA125 (4 UNITIES) AXES (CYLINDRE-CULASSE-CARTER) - PA125 (4 UNITÉES)	10,00 €
	PA006	RETEN CIGÜEÑAL - PA125 (20-35-7) CRANKSHAFT SEAL - PA125 (20-35-7) JOINT SPI VILEBREQUIN - PA125 (20-35-7)	6,00 €

PA125

BLOQUE MOTOR
MOTOR BLOCK
BLOQUE MOTEUR

 page
4/4

PVP

	PA004	CIGUEÑAL CON BIELA - PA125 CRANKSHAFT - PA125 VILEBREQUIN AVEC BIELE - PA125	262,50 €
	PA005	RODAMIENTO CIGUEÑAL - PA125 (3055) (antes de 2012) CRANKSHAFT BEARING - PA125 (3055) (before 2012) ROULEMENT VILEBREQUIN - PA125 (3055) (avant 2012)	22,50€
	PA005N	RODAMIENTO CIGUEÑAL - PA125 (6204 C3 TN9) (despues de 2012) CRANKSHAFT BEARING - PA125 (6204 C3 TN9) (after 2012) ROULEMENT VILEBREQUIN - PA125 (6204 C3 TN9) (apres 2012)	20,00 €
	PA016	CARTER PA125 (DELANTERO + TRASERO + SOPORTE) CRANKSHAFT CARTER PA125 (FRONT + BACK + SUPPORT) CARTER PA125 (AVANT + ARRIÈRE + SUPPORT)	422,00 €

RM80 PA125

REDUCTORA
REDUCTOR
RÉDUCTEUR

 page
1/3

PVP

	RP220	TORNILLO SUJECCION SOPORTE DE HELICE M6 BACK PROPELLER PLATE HOLDING SCREW M6 VIS ACCOUPLEMENT DE PLAQUE ARRIÈRE D'HÉLICE M6	0,50 €
	RP222	ARANDELA ESTRIADA M6 (TORNILLO RP220) DENTED WASHER M6 (SCREW RP220) RONDELLE DENTÉE M6 (VIS RP220)	0,37 €
	RP222A	ARANDELA ANCHA M6 (TORNILLO RP220) LARGE WASHER M6 (SCREW RP220) RONDELLE LARGE M6 (VIS RP220)	0,50 €
	RP225	CONTRAPLACA HELICE FRONT PROPELLER PLATE PLAQUE AVANT DE SOUTIEN DE L'HÉLICE	8,50 €
	RP219	SOPORTE HÉLICE PROPELLER PLATE SUPPORT HELICE	24,50 €
	RP221	TORNILLOS M5 CARTER DELANTERO REDUCTORA (RP201) (5 UNIDADES) REDUCTION CASING FRONT COVER (RP201) SCREWS M5 (5 UNITS) VIS M5 CARTER AVANT REDUCTEUR (RP201) (5 UNITÉS)	2,00 €
	RP201	CARTER REDUCTORA REDUCTION CASE CARTER REDUCTEUR	262,50 €
	RP212	RETEN REDUCTORA (TAPA CARTER) 17-30-7 REDUCTOR SEALER (CASE FRONT COVER) 17-30-7 JOINT SPY (CARTER AVANT REDUCTEUR) 17-30-7	7,00 €
	RP212N	RETEN REDUCTORA (TAPA CARTER) 20-30-6 REDUCTOR SEALER (CASE FRONT COVER) 20-30-6 JOINT SPY (CARTER AVANT REDUCTEUR) 20-30-6	7,00 €
	RP210	RODAMIENTO REDUCTORA 6002 C3 REDUCTOR BEARING 6002 C3 ROULEMENT REDUCTEUR 6002 C3	6,75 €
	RP210N	RODAMIENTO REDUCTORA 6204 C3 REDUCTOR BEARING 6204 C3 ROULEMENT REDUCTEUR 6204 C3	7,00 €
	RP211	RODAMIENTO REDUCTORA 6000 REDUCTOR BEARING 6000 ROULEMENT REDUCTEUR 6000	10,50 €
	RP211N	RODAMIENTO REDUCTORA 6200 REDUCTOR BEARING 6200 ROULEMENT REDUCTEUR 6200	6,00 €
	RP209	CHAVETA REDUCTORA - EJE ø17 COTTER PIN REDUCTION - ø17 SHAFT CLAVETTE DE REDUCTEUR - AXE ø17	2,25 €
	RP209B	CHAVETA REDUCTORA - EJE ø20 COTTER PIN REDUCTION - ø20 SHAFT CLAVETTE DE REDUCTEUR - AXE ø20	2,25 €

	RP206	PIÑÓN REDUCTORA GRANDE - EJE ø20 BIG REDUCTION WHEEL - ø20 SHAFT PIGNON DE REDUCTION GRAND - AXE ø20	41,25 €
	RP215	PIÑÓN REDUCTORA PEQUEÑO SMALL REDUCTION WHEEL PIGNON DE REDUCTION PETITE	21,00 €
	RP208	CLIP REDUCTORA (Anillo seger 35mm) (1 UNIDAD) REDUCTOR RING / CLIP (Seeger Ring 35mm) (1 UNIT) CLIP REDUCTEUR (Anneaux seger 35mm) (1 UNITÉ)	1,37 €
	RP204N1	RODAMIENTO REDUCTORA 6003 REDUCTOR BEARING 6003 ROULEMENT REDUCTEUR 6003	6,50 €
	RP204N2	RODAMIENTO REDUCTORA 6202 REDUCTOR BEARING 6202 ROULEMENT REDUCTEUR 6202	6,75 €
	RP217	JUNTA TORICA REDUCTORA TORRICAL REDUCTION GASKET JOINT TORRIQUE REDUCTEUR	2,62 €
	RP217N	JUNTA TORICA REDUCTORA Nuevo Modelo 2013 TORRICAL REDUCTION GASKET New Model 2013 JOINT TORRIQUE REDUCTEUR Nouvele Modele 2013	2,62 €
	RP232	TORNILLOS M5 CARTER TRASERO REDUCTORA (RP202) (4 UNIDADES) REDUCTION CASE BACK COVER (RP202) SCREWS M5 (4 UNITS) VIS M5 CARTER ARRIÈRE REDUCTEUR (RP202) (4 UNITÉS)	3,20 €
	RP236	TORNILLO DE VACIADO EMPTYING SCREW VIS DE VIDANGE	0,75 €
	RP223	VALVULA DE DESCOMPRESION BREATHER VALVE RENIFLARD	6,68 €
	RP203	CAMPANA DE EMBRAGUE CLUTCH BELL CLOCHE D'EMBRAYAGE	30,00 €
	RP207	RETEN REDUCTORA (CAMPANA DE EMBRAGUE) 20-35-7 REDUCTOR SEALER (CLUTCH BELL) 20-35-7 JOINT SPY (CLOCHE D'EMBRAYAGE) 20-35-7	6,30 €
	RP218	TUERCA SUJECION EMBRAGUE M10 CLUTCH HOLDING NUT M10 ECROU DE FIXATION EMBRAYAGE M10	2,87 €
	RP243	ARANDELA EMBRAGUE CLUTCH WASHER RONDELLE EMBRAYAGE	0,50 €
	RP231	CHAVETA EMBRAGUE CLUTCH COTTER PIN CLAVETTE DE EMBRAYAGE	2,50 €
	RP205	EMBRAGUE CLUTCH EMBRAYAGE	75,00 €
	RP237	CLIP (EJE ZAPATA EMBRAGUE) Anillo seeger. CLIP (CLUCTH SHOE SHAFT) Seeger. CLIP (AXE MACHOIRE D'EMBRAYAGUE) Anneaux seeger.	0,75 €
	RP228	MUELLE (ZAPATA EMBRAGUE) SPRING (SHOE SHAFT) RESSORT (MACHOIRE D'EMBRAYAGUE)	3,37 €
	RP238	TORNILLO (MUELLE ZAPATA EMBRAGUE) SCREW (SPRING SHOE SHAFT) VIS (RESSORT MACHOIRE D'EMBRAYAGUE)	0,62 €
	RP213	REDUCTORA COMPLETA COMPLETE REDUCTION SYSTEM REDUCTEUR COMPLET	370,00 €
	RP206EK	KIT ACTUALIZACION EJE ø20 (RP210N, RP206/E, RP212N, RP219/E, RP209, RP220, RP222, RP222A) ø20 SHAFT UPDATE KIT (RP210N, RP206/E, RP212N, RP219/E, RP209, RP220, RP222, RP222A) KIT ACTUALISATION AXE ø20 (RP210N, RP206/E, RP212N, RP219/E, RP209, RP220, RP222, RP222A)	76,50 €

RM80 PA125

REDUCTORA
REDUCTOR
RÉDUCTEUR

 page
3/3

PVP

	H6440	KIT TORNILLOS HELICE M6 X 40mm. 4 Unidades KIT SCREW M6 X 40 mm. PROPELLER. 4 Unities KIT VIS HELICE M6 X 40 mm. 4 Unitées	2,00 €
	H6450	KIT TORNILLOS HELICE M6 X 50mm. 4 Unidades KIT SCREW M6 X 50 mm. PROPELLER. 4 Unities KIT VIS HELICE M6 X 50 mm. 4 Unitées	2,00 €

RM80 PA125

TUBO ESCAPE
EXHAUST PIPE
TUBE D'ÉCHAPPEMENT





 page
1/5

PVP





	RP321	JUNTAS TORICAS ESCAPE (VITON) (2 UNIDADES) EXHAUST GASKET (VITON) (2 UNITIES) JOINT TORIQUE (VITON) (2 UNITÉES)	9,00 €
	RP304	ARANDELA DENTADA (TORNILLO RP309) (2 UNIDADES) DENTED WASHER (SCREW RP309) (2 UNITS) RONDELLE DENTÉE (VIS RP309) (2 UNITÉS)	3,00 €
	RP309	TORNILLOS ROTULA - CILINDRO (2 UNIDADES) ROTULAR - CILINDER SCREWS (2 UNITS) VIS DE L'ARTICULATION ROTULAIRE - CILINDRE (2 UNITÉS)	1,50 €
	RP302	MUELLE ESCAPE SPRINGS FOR EXHAUST SYS RESSORTS SYS. D'ÉCHAPPEMENT	1,50 €
	RP306	TORNILLOS DE SUJECION ROTULA - ESCAPE M6X50 (3 UNIDADES) ROTULAR - EXHAUST JOINT SCREWS M6X50 (3 UNITS) VIS DE L'ARTICULATION ROTULAIRE - TUBE D'ÉCHAPPEMENT M6X50 (3 UNITÉS)	2,25 €
	RP307	TUERCAS M6 AUTOBLOQUANTES DE ROTULA ESCAPE (TORNILLO RP306) (3 UNIDADES) LOCK NUT TO HOLD THE EXHAUST BALL JOINT M6 (SCREW RP306) (3 UNITS) ECROU M6 AUTOBLOQUANT DE MAINTIENT DE LA ROTULE (VIS RP306) (3 UNITÉS)	1,50 €
	RP306K	KIT SUJECION ROTULA - ESCAPE (3 UNIDADES) RP306 + RP302 + RP307 + RP313 ROTULAR - EXHAUST JOINT KIT (3 UNITS) RP306 + RP302 + RP307 + RP313 KIT FIXATION ROTULAIRE - TUBE D'ÉCHAPPEMENT (3 UNITÉS) RE306 + RP302 + RP307 + RP313	8,12 €
	RP328	TUERCA M8 AUTOBLOCANTES (ABRAZADERA DEL SILENCIOSO) LOCK NUT M8 (SILENCER METAL BRACE) ECROU M8 AUTOBLOQUANT (COLLIER POUR SILENCIEUX)	0,50 €
	RP329	ARANDELA M8 GROWER (ABRAZADERA DEL SILENCIOSO) GROWER WASHER M8 (SILENCER METAL BRACE) RONDELLE M8 GROWER (COLLIER POUR SILENCIEUX)	0,37 €
	RP315	GOMA DE UNION SILENCIADOR UNION RUBBER FOR MUFFLER GOMME UNION SILENCIEUX	12,00 €
	RP323	CABLE DE SEGURIDAD DEL SILENCIADOR DEL ESCAPE + 2 CIERRES SEGURIDAD CABLE SECURITY CABLE OF THE EXHAUST SILENCER + 2 SOLDERESS NIPPLE FOR CABLE CÂBLE DE SÉCURITÉ DU SILENCIEUX DE L'ÉCHAPPEMENT + 2 COLLIER CABLE DE SÉCURITÉ	2,00 €
	RP324	PLETINA DE CABLE DE SEGURIDAD DEL SILENCIADOR DEL ESCAPE METAL PLATE SECURITY CABLE OF THE EXHAUST SILENCER PLETINE CÂBLE DE SÉCURITÉ DU SILENCIEUX DE L'ÉCHAPPEMENT	2,00 €
	A58	CIERRE SEGURIDAD CABLE (SILENCIADOR DEL ESCAPE) SOLDERESS NIPPLE FOR CABLE (EXHAUST SILENCER) COLLIER CABLE DE SÉCURITÉ (SILENCIEUX DE L'ÉCHAPPEMENT)	0,50 €
	RP331	SILENTBLOC ABRAZADERA DEL SILENCIOSO SILENCER METAL BRACE SILENTBLOC SILENTBLOC COLLIER POUR SILENCIEUX	3,75 €
	RP314	SILENCIOSO COMPLETO COMPLETE SILENCER SILENCIEUX COMPLET	108,75 €
	RP316	ABRAZADERA DEL SILENCIOSO SILENCER METAL BRACE COLLIER POUR SILENCIEUX	7,50 €
	RP317	GOMA DE ABRAZADERA SILENCER BRACE RUBBER BAND LANGUETTE CAOUTCHOUC POUR COLLIER	4,50 €

	RP330	TORNILLO M8 KIT ABRAZADERA M8 SCREW BRASE MOUNTING KIT VIS M8 KIT MONTAGE COLLIER SILENCIEUX	0,87 €
	RP318	KIT ABRAZADERA DEL SILENCIOSO SILENCER METAL BRACE KIT KIT COLLIER POUR SILENCIEUX	16,25 €
	RP320	FIBRA SILENCIADOR SILENCER FIBER FIBRE SILENCIEUX	10,50 €
	RP325	JUNTA DE SILENCIOSO SILENCER PAPER GASKET JOINT DE SILENCIEUX	1,50 €

RM80 - RM80 - RM80 - RM80 - RM80 - RM80 - RM80

	RM303	ROTULA - RM80 ROTULAR CONNETION - RM80 ROTULE - RM80	28,75 €
	RM119	JUNTA ESCAPE - RM80 EXHAUST GASKET - RM80 JOINT D'ÉCHAPPEMENT - RM80	3,00 €
	RM335SN	ESCAPE SIN SILENCIADOR - RM80 EXHAUST WITHOUT SILENCER - RM80 POT D'ÉCHAPPEMENT SANS SILENCIEUX - RM80	206,25 €
	RM335	ESCAPE COMPLETO - RM80 COMPLETE EXHAUST FOR - RM80 POT D'ÉCHAPPEMENT COMPLET - RM80	325,00 €

PA125 - PA125 - PA125 - PA125 - PA125 - PA125

	PA301	ROTULA - PA125 ROTULAR CONNECTION - PA125 ROTULE - PA125	28,75 €
	PA321	JUNTA ESCAPE - PA125 EXHAUST GASKET - PA125 JOINT D'ÉCHAPPEMENT - PA125	3,00 €
	PA335SN	ESCAPE SIN SILENCIADOR - PA125 EXHAUST WITHOUT SILENCER - PA125 POT D'ÉCHAPPEMENT SANS SILENCIEUX - PA125	206,25 €
	PA334	ESCAPE COMPLETO - PA125 COMPLETE EXHAUST FOR - PA125 POT D'ÉCHAPPEMENT COMPLET - PA125	325,00 €

RM80 PA125

	RP408	SEPARADOR ALUMINIO ALUMINIUM SEPARATOR ENTRETOISE ALUMINIUM	6,00 €
	RP405	PLACA SEPARADORA PLATO/VENTILADOR SEPARATION MAGNETO/COOLING FAN SÉPARATEUR PLATEAU/VENTILATEUR	12,75 €
	RP411	ARANDELA GROWER M6 (PASANTE RP024) GROWER WASHER M6 (BRASS SCREW RP024) RONDELLE GROWER M6 (GUIDE RP024)	0,37 €
	RP024	PASANTE PARA CABLE DE ACELERADOR THROTTLE CABLE BRASS SCREW GUIDE POUR CABLE ACCELERATEUR EN LAITON	2,25 €
	RP419	ARANDELAS DE VENTILADOR M6 (2 UNIDADES) COOLING FAN WASHERS M6 (2 UNITS) RONDELLES DE VENTILATEUR M6 (2 UNITÉS)	0,62 €
	RP418	ARANDELAS GROWER M6 DE VENTILADOR (2 UNIDADES) COOLING FAN GROWER WASHERS M6 (2 UNITS) RONDELLES GROWER DE VENTILATEUR M6 (2 UNITÉS)	0,75 €







	RP415	TORNILLOS SUJECION VENTILADOR M6 (2 UNIDADES) SCREW HOLDING THE FAN M6 (2 UNITS) VIS DE MAINTIEN VENTILATEUR M6 (2 UNITÉS)	1,25 €
	RP422	EJE CLIQUET M8 STUD CLIQUET M8 AXE CLIQUET M8	4,37 €
	RP423	MUELLE CLIQUET CLIQUET SPRING RESSORT CLIQUET	1,00 €
	RP424	CLIQUET CLIQUET CLIQUET	8,75 €
	RP426	CLIP CLIQUET (ANILLO SEGER 6,8MM) CLIQUET RING / CLIP (SEGER 6,8MM) CLIP CLIQUET (ANNEAUX SEGER 6,8MM)	0,40 €
	RP428	KIT CLIQUET (1 EJE, 1 MUELLE, 1 CLIQUET) KIT CLIQUET (1 STUD, 1 SPRING, 1 CLIQUET) KIT CLIQUET (1 AXE, 1 RESSORT, 1 CLIQUET)	14,13 €
	RP420	TORNILLOS M4 DE CARCASA TRASERA (RP406) (3 UNIDADES) VENT CASSING (RP406) SCREWS M4 (3 UNITS) VIS M4 DE CARCASSE (RP406) (3 UNITÉS)	1,50 €
	RP430	CARCASA TRASERA + PLACA DEL VENTILADOR VENT CASSING + COOLING FAN BACK PLATE CARCASSE + PLAQUE ARRIÈRE VENTILATEUR	58,75 €
	RP439	ARANDELAS M8 (SILENTBLOCKS INFERIORES MOTOR) (2 UNIDADES) WASHERS M8 (LOWER SILENTBLOCKS MOTOR) (2 UNITS) RONDELLE PLATES M8 (SILENTBLOCK INFERIUR MOTEUR) (2 UNITÉS)	0,75 €
	RP117	SILENTBLOCK M8 30X25MM (MOTOR) SILENTBLOCK M8 30X25MM (MOTOR) SILENTBLOCK M8 30X25MM (MOTEUR)	3,75 €
	RP020	CINTA DE SEGURIDAD SILENTBLOCKS MOTOR SECURITY BELT FOR MOTOR SILENTBLOCKS SANGLE DE SÉCURITÉ DE SILENTBLOCKS MOTEUR	1,87 €
	RP407	TORNILLOS SILENTBLOCKS MOTOR M8 (4 UNIDADES) SCREWS M8 (4 UNITS) (MOTOR SILENTBLOCKS) VIS SILENTBLOCKS MOTEUR M8 (4 UDS.)	2,00 €
	RP407A	ARANDELAS M8 (TORNILLOS RP407) (4 UNIDADES) WASHERS M8 (4 UNITS) (SCREWS RP407) RONDELLES M8 (4 UNITÉS) (VIS RP407)	1,50 €
	RP437	TORNILLO M5 POLEA ARRANQUE SCREW M5 (STARTER PULLEY) VIS M5 POULIE DEMARREUR	0,62 €
	RP412	ARANDELAS ESTRIADA M5 (TORNILLO RP437) (2 UNIDADES) DENTED WASHERS M5 (SCREW RP437) (2 UNITS) RONDELLES DENTÉE M5 (VIS RP437) (2 UNITÉS)	0,62 €
	RP438	ARANDELA ANCHA M5 (TORNILLO RP437) LARGE WASHER M5 (SCREW RP437) RONDELLE LARGE M5 (VIS RP437)	0,37 €
	RP425	POLEA DE ARRANQUE MANUAL PLASTIC MANUAL STARTER PULLEY POULIE DEMARREUR MANUEL	10,50 €
	RP414	CUERDA ARRANQUE ROPE FOR MANUAL START CORDE DÉMARREUR	3,00 €
	A66	ASA ARRANQUE MANUAL, TODOS LOS MODELOS HANDLE FOR MANUAL STARTER POIGNÉE DEMARREUR MANUEL, TOUS LES MODELES	5,00 €
	RP431	FUNDA EXTERIOR CUERDA ARRANQUE (7CM) OUTER COVER FOR ROPE (7CM) GAINÉ EXTÉRIEURE CORDE DÉMARREUR (7CM)	0,50 €
	RP413	MUELLE DE ARRANQUE PULL START SPRING RESSORT DE DÉMARREUR	7,50 €

RM80 PA125

ENCENDIDO Y ARRANQUE
IGNITION & STARTER
ALLUMAGE ET DEMARREUR

page
1/5

PVP

	RP436	ARANDELAS M4 CARTER ARRANQUE (3 UNIDADES) WASHERS M4 (3 UNITS) (PULL START PLATE) RONDELLES M4 PLAQUE DE DÉMARREUR (3 UNITÉS)	0,75 €
	RP433	TUERCAS AUTOBLOCANTES M4 CARTER ARRANQUE (3 UNIDADES) LOCK NUTS M4 (3 UNITS) (PULL START PLATE) ECROUS AUTOBLOQUANT M4 PLAQUE DE DÉMARREUR (3 UNITÉS)	1,00 €
	RP409	ARRANQUE MANUAL COMPLETO MANUEL START COMPLET DÉMARREUR MANUEL COMPLETE	81,25 €
	RP499	MUELLE DE RETROCESO BACKWARD SPRING RECU L RESSORT	0,75 €
	RM401	VENTILADOR RM80 RM80 COOLING FAN VENTILATEUR RM80	41,25 €
	PA401	VENTILADOR PA125 PA125 COOLING FAN VENTILATEUR PA125	41,25 €



RM80 PA125

ADMISION
ADMISSION
ADMISSION



page
1/2

PVP



	RP505	JUNTA CAJA DE LAMINAS TRASERA LAMINAR INTAKE BACK PAPER GASKET JOINT ARRIÈRE DE BOÎTE À CLAPET	1,50 €
	RP508	CAJA LAMINAS REED VALVE BOÎTE À CLAPPETS	35,60 €
	RP516	LAMINA (1 UNIDAD) REED VALVE SHEET (1 UNITE) LAMELLE (1 UNITÉ)	11,25 €
	RP504	JUNTA CAJA DE LAMINAS DELANTERA LAMINAR INTAKE FRONT PAPER GASKET JOINT AVANT DE BOÎTE À CLAPET	1,50 €
	RP506	PLACA SUJECION CARBURADOR ALUMINIUM FLANGE CARBURATTOR PLAQUE ALUMINIUM DE CARBURATEUR	18,00 €
	RP503	JUNTA CARBURADOR CARBURETTOR PAPER GASKET JOINT DE CARBURATEUR	1,50 €
	RP507	PLACA SUJECIÓN FILTRO AIRE AIR FILTER HOLDING FLANGE PLAQUE DE SOUTIENT DE FILTRE À AIR	10,00 €
	RP513	ABRAZADERA DEL AIRBOX METAL BRACE FOR AIR BOX COLLIER POUR BOÎTE À AIR	5,00 €
	RP511	GOMA DE UNION CARBURADOR - SILENCIADOR DE ADMISION (AIRBOX) CARBURETTOR - AIRBOX RUBBER JONCTION GOMME UNION CARBURATEUR - AIRBOX	11,62 €
	RP506T	TORNILLOS (PLACA SUJECION CARBURADOR RP506) (4 UNIDADES) SCREWS (ALUMINIUM FLANGE CARBURETTOR RP506) (4 UNITS) VIS (PLAQUE ALUMINIUM DE CARBURATEUR RP506) (4 UNITÉS)	1,50 €
	RP507T	TORNILLOS (PLACA SUJECIÓN FILTRO AIRE) (2 UNIDADES) SCREWS (AIR FILTER HOLDING FLANGE) (2 UNITS) VIS (PLAQUE DE SOUTIENT DE FILTRE À AIR) (2 UNITÉS)	2,50 €
	RP517	TORNILLOS M4 - KIT FIJACION AIRBOX (2 UNIDADES) AIRBOX FIXATION KIT - SCREWS M4 (2 UNITS) VIS M4 - KIT FIXATION AIRBOX (2 UNITÉS)	0,75 €
	RP518	TUERCAS - KIT FIJACION AIRBOX (2 UNIDADES) AIRBOX FIXATION KIT - LOCK NUTS (2 UNITS) ECROUS- KIT FIXATION AIRBOX (2 UNITÉS)	0,75 €

	RP520	PLACA AIRBOX AIR BOX PLATE PLAQUE BOÎTE À AIR	2,50 €
	RP514	ESCUADRA AIRBOX AIR BOX SQUARE ÉQUERRE BOÎTE À AIR	3,75 €
	RP519	MINISILENTBLOC (TH) AIRBOX (2 UNIDADES) AIR BOX SILENTBLOC (TH) (2 UNITS) MINISILENTBLOC (TH) BOÎTE À AIR (2 UNITÉS)	5,00 €

RM80 - RM80 - RM80 - RM80 - RM80 - RM80 - RM80

	RM502	CARBURADOR WG8 - RM80 WG8 CARBURETTOR - RM80 CARBURATEUR WG8 - RM80	175,00 €
	RM501	SILENCIADOR DE ADMISIÓN (AIRBOX) + GOMA DE UNION CARBURADOR + TUBO DE PLASTICO 30 MM - RM80 AIRBOX + CARBURETTOR - AIRBOX RUBBER JONCTION + VENTURI PLASTIC TUBE 30MM - RM80 AIRBOX + GOMME UNION CARBURATEUR + TUBE PLASTIC 30MM - RM80	75,00 €

PA125 - PA125 - PA125 - PA125 - PA125 - PA125

	PA502	CARBURADOR WG8 - PA125 WG8 CARBURETTOR - PA125 CARBURATEUR WG8 - PA125	175,00 €
	PA501	SILENCIADOR DE ADMISIÓN (AIRBOX) + GOMA DE UNION CARBURADOR + TUBO DE PLASTICO 30 MM - PA125 AIRBOX + CARBURETTOR - AIRBOX RUBBER JONCTION + VENTURI PLASTIC TUBE 30MM - PA125 AIRBOX + GOMME UNION CARBURATEUR + TUBE PLASTIC 30MM - PA125	75,00 €

SAFARI125

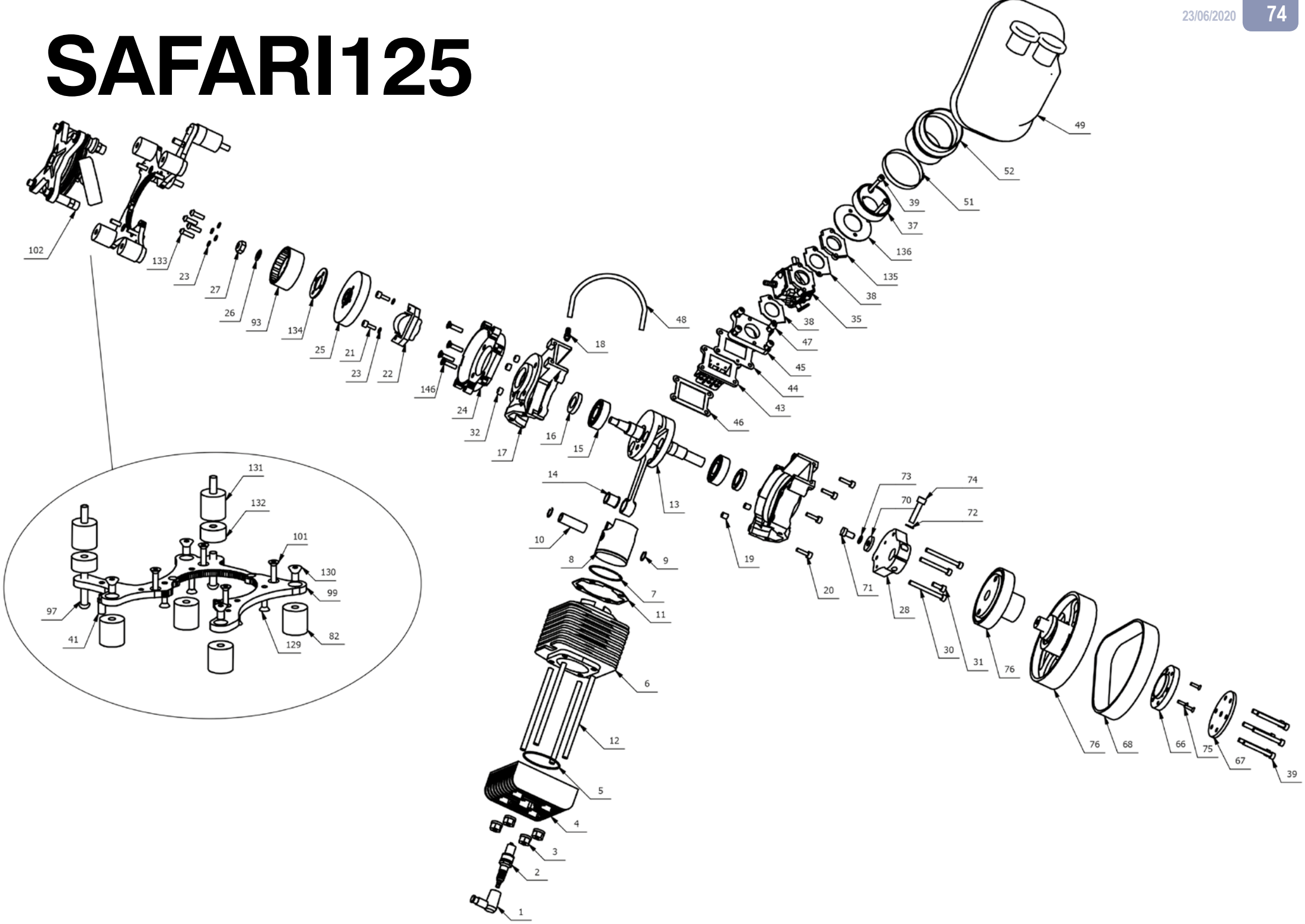

SAFARI125

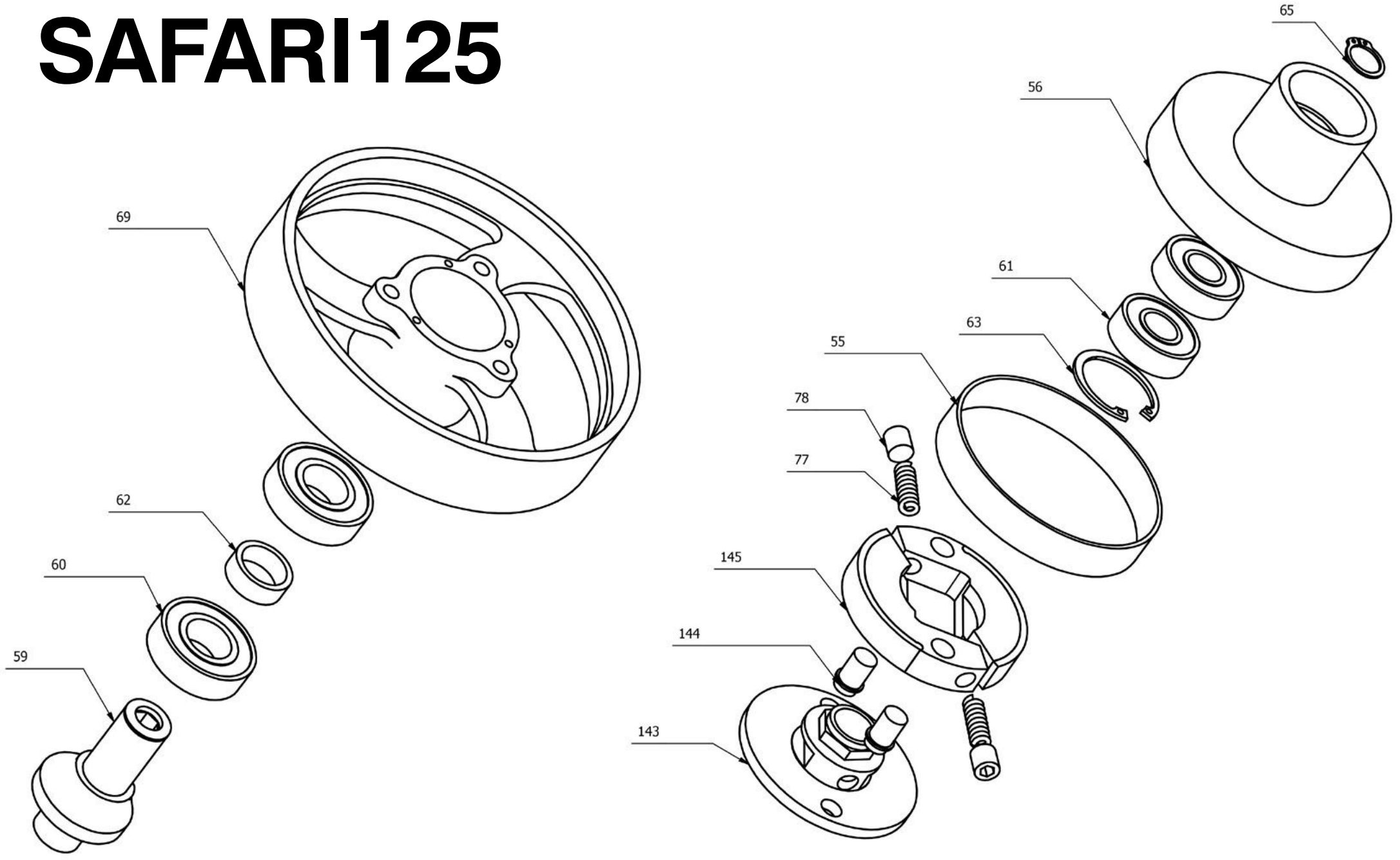

SAFARI125

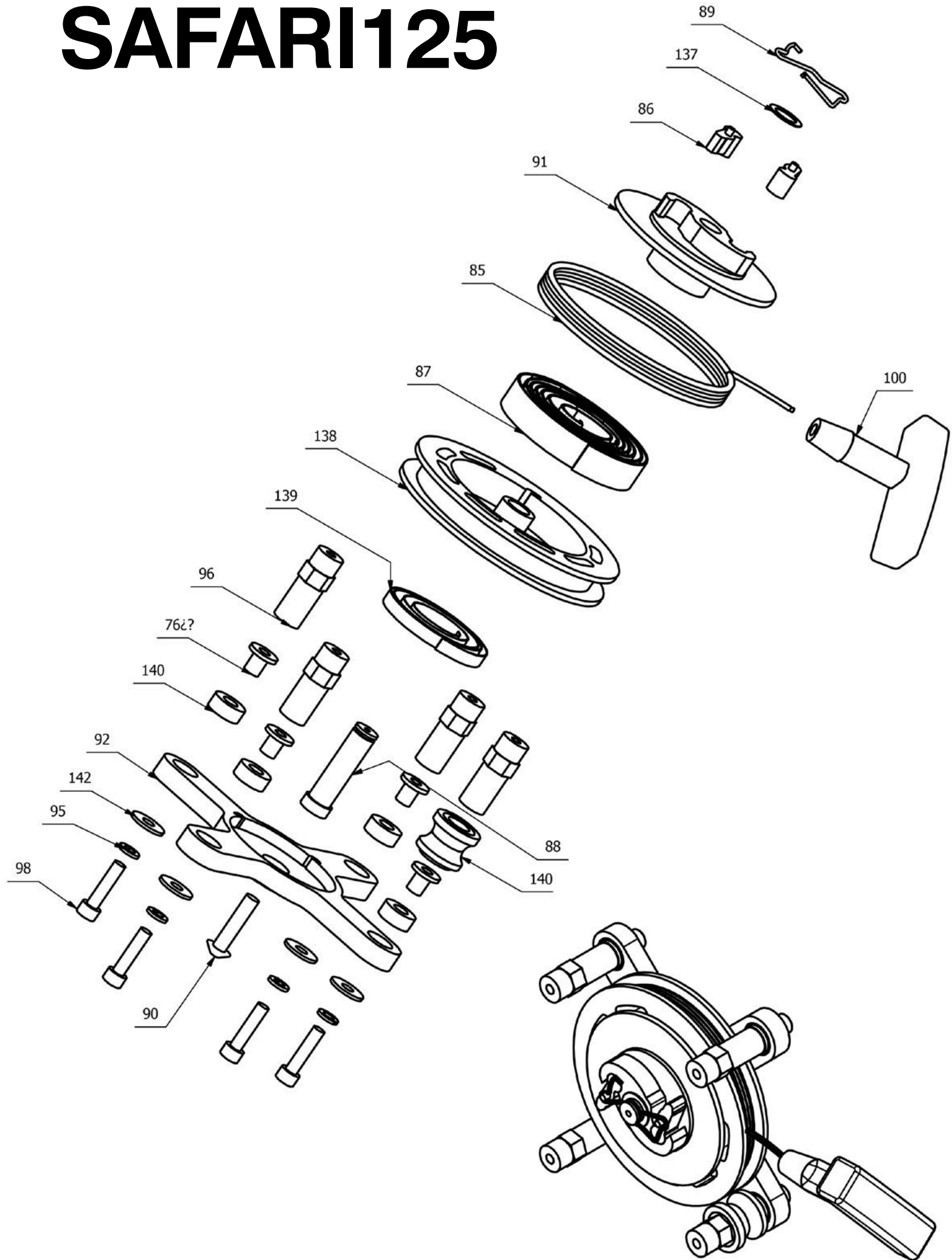

SAFARI125

BLOQUE MOTOR
MOTOR BLOCK
BLOQUE MOTEUR

page
1/5

PVP

SF001	PIPA DE BUJÍA SPARK PLUG CAP CAPUCHON DE BOUGIE	13,36 €
SF002	BUJÍA BR10ES SPARK PLUG BR10ES BOUGIE BR10ES	5,16 €
SF003	TUERCA DE CULATA M.8 CYLINDER HEAD NUT M.8 ÉCROU DE CULASSE M.8	3,72 €
SF004	CULATA CYLINDER HEAD CULASSE	140,83 €
SF005	JUNTA CULATA TÓRICA VITÓN CYLINDER HEAD GASKET JOINT TORRIQUE DE CULASSE	6,25 €
SF006	CILINDRO CYLINDER CYLINDRE	209,30 €
SF007	SEGMENTO DE PISTÓN PISTON RING SEGMENT	19,53 €
SF008	PISTON COMPLETO (SEGMENTO Y BULON) COMPLETE PISTON (SEGMENT & BOULON) PISTON COMPLET (SEGMENT ET BOULON)	62,81 €
SF009	CLIPS DEL BOULON (2 UNIDADES) BOULON CLIPS (2 UNITIES) CLIPS DE BOULONS (2 UNITÉES)	2,97 €
SF010	BULON PISTON BOULON AXE DE PISTON	8,91 €
SF011	JUNTA DE CILINDRO CYLINDER GASKET JOINT CYLINDRE	2,13 €
SF012	ESPARRAGOS (CILINDRO-CULATA-CARTER) (4 UNIDADES) STUDS (CYLINDER-HEAD CYLINDER-CARTER) (4 UNITIES) AXES (CYLINDRE-CULASSE-CARTER) (4 UNITÉES)	3,90 €
SF013	CIGUEÑAL CON BIELA CRANKSHAFT VILEBREQUIN AVEC BIELE	141,56 €
SF014	RODAMIENTO PISTON PISTON BEARING ROULEMENT PISTON	11,33 €
SF015	RODAMIENTO CIGUEÑAL 6204 (2 UNIDADES) CRANKSHAFT BEARING 6204 (2 UNITIES) ROULEMENT VILEBREQUIN 6204 (2 UNITÉES)	15,47 €
SF016	RETEN CIGÜEÑAL (20-35-7) (4 UNIDADES) CRANKSHAFT SEAL (20-35-7) (4 UNITIES) JOINT SPI VILEBREQUIN (20-35-7) (4 UNITÉES)	32,20 €
SF017	CARTER CRANKSHAFT CARTER CARTER	492,19 €
SF018	DEPRESION CARTER MOTOR CARTER DEPRESSION EXIT DEPRESSION CARTER MOTEUR	1,88 €
SF019	FIJA DE CÁRTER (2 UNIDADES) GUIDING BRACE (2 UNITIES) ENTRETOISE (2 UNITÉES)	3,27 €
SF020	TORNILLOS DE CARTER (4 UNIDADES) CARTER SCREWS (4 UNITIES) VIS CARTER (4 UNITÉES)	1,50 €
SF021	TORNILLO DE BOBINA ALLEN M.5 (2 UNIDADES) COIL SCREWS M5 (2 UNITIES) VIS DE BOBINE M5 (2 UNITÉES)	0,95 €

SAFARI125

BLOQUE MOTOR
MOTOR BLOCK
BLOQUE MOTEUR

page
1/5

PVP

SF022	BOBINA COIL BOBINE	36,72 €
SF023	ARANDELAS M5 (TORNILLOS DE BOBINA) (2 UNIDADES) WASHERS M5 (COIL SCREWS) (2 UNITIES) RONDELLES M5 (VIS DE BOBINE) (2 UNITÉES)	0,95 €
SF024	PLACA DE BOBINA COIL PLATE PLAQUE BOBINE	99,53 €
SF025	PLATO MAGNÉTICO MAGNETIC PLATE PLATEAU MAGNÉTIQUE	48,75 €
SF026	ARANDELA PLATO MAGNÉTICO MAGNETIC PLATE WASHER RONDELLE PLATEAU MAGNÉTIQUE	0,47 €
SF027	TUERCA PLATO MAGNÉTICO AUTOBROCANTE M.10 MAGNETIC PLATE HOLDING NUT M10 ÉCROU DE FIXATION PLATEAU MAGNÉTIQUE M10	0,47 €
SF028	PLACA DE POLEA PULLEY PLATE PLAQUE POULIE	78,44 €
SF029	TORNILLO DE POLEA M.6X16 PULLEY SCREW M.6X16 VIS POULIE M.6X16	0,47 €
SF030	TORNILLO PLACA POLEA M.6X60 (2 UNIDADES) PULLEY PLATE SCREW M.6X60 (2 UNITIES) VIS PLAQUE POULIE M.6X60 (2 UNITÉES)	0,95 €
SF031	TORNILLO PLACA POLEA M.6X55 PULLEY PLATE SCREW M.6X55 VIS PLAQUE POULIE M.6X55	0,47 €
SF032	TUERCA SUJ. PLACA POLEA PULLEY PLATE NUT ÉCROU PLAQUE POULIE	0,47 €
SF033	TORNILLO PLACA BOBINA M.8 COIL PLATE NUT M.8 ÉCROU PLAQUE BOBINE M.8	0,47 €
SF034	CILINDRO + PISTON CYLINDER + PISTON CYLINDRE + PISTON	272,11 €

SAFARI125

ADMISION
ADMISSION
ADMISSION

page
1/5

PVP

SF035	CARBURADOR WG8 WG8 CARBURETTOR CARBURATEUR WG8	191,41 €
SF036	PLACA SUJECCIÓN CARBURADOR CARBURATOR HOLDING FLANGE PLAQUE DE SOUTIENT DE CARBURATEUR	20,50 €
SF037	PLACA DE ALUMINIO ALUMINIUM PLATE PLAQUE ALUMINIUM	19,92 €
SF038	JUNTA CARBURADOR CARBURETTOR PAPER GASKET JOINT DE CARBURATEUR	5,08 €
SF039	TORNILLO LARGO CARBURADOR (2 UNIDADES) SCREW CARBURETTOR (2 UNITIES) VIS CARBURATEUR (2 UNITÉES)	0,95 €
SF040	ARANDELA M.6 SUJECCIÓN CABLE THROTTLE CABLE BRASS WASHER M.6 RONDELLE M.6 POUR CABLE ACCÉLÉRATEUR EN LAITON	0,47 €

SAFARI125

ADMISION
ADMISSION
ADMISSION

page
1/5

PVP

SF041	TORNILLO SUJECCIÓN CABLE THROTTLE CABLE BRASS SCREW GUIDE POUR CABLE ACCÉLÉRATEUR EN LAITON		0,47 €
SF042	TUERCA M.6 SUJECCIÓN CABLE THROTTLE CABLE BRASS NUT M.6 ÉCROU M.6 POUR CABLE ACCÉLÉRATEUR EN LAITON		0,47 €
SF043	CAJA LAMINAS REED VALVE BOÎTE À CLAPETS		38,28 €
SF044	JUNTA CAJA DE LAMINAS DELANTERA LAMINAR INTAKE FRONT PAPER GASKET JOINT AVANT DE BOÎTE À CLAPETS		1,48 €
SF045	PLACA SUJECION CARBURADOR CARBURATTOR FLANGE PLAQUE DE CARBURATEUR		22,81 €
SF046	JUNTA CAJA DE LAMINAS TRASERA LAMINAR INTAKE BACK PAPER GASKET JOINT ARRIÈRE DE BOÎTE À CLAPET		1,48 €
SF047	TORNILLO PLACA CAJA DE LÁMINA M.6 CARBURATTOR FLANGE SCREW M.6 M.6 VIS PLAQUE DE CARBURATEUR		0,47 €
SF048	TUBO CARBURADOR PIPE PRESSURE TUBE CARBURATEUR		1,64 €
SF049	SILENCIADOR DE ADMISIÓN DE CARBONO (AIRBOX) CARBON AIRBOX SILENCIEUX D'ADMISSION CARBONE (AIRBOX)	Includes: SF052, SF051	102,50 €
SF051	ABRAZADERA DEL SILENCIADOR DE ADMISIÓN (AIRBOX) METAL BRACE FOR AIRBOX COLLIER POUR SILENCIEUX D'ADMISSION (AIRBOX)		5,00 €
SF052	GOMA DE UNIÓN AIRBOX CON CARBURADOR FOAM FILTER SMALL SIZE FOAM FILTER SMALL SIZE		30,00 €
SF054	KIT DE LÁMINAS (2 UNIDADES) REED VALVE SHEETS (2 UNITÉS) LAMELLES (2 UNITÉS)		12,50 €

SAFARI125

REDUCTORA
REDUCTOR
RÉDUCTEUR

page
1/5

PVP

SF055	ARANDELA DE POLEA PULLEY WASHER RONDELLE POULIE		0,47 €
SF056	POLEA PEQUEÑA SMALL PULLEY PETITE POULIE		70,31 €
SF057	PLACA DE HÉLICE TRASERA BACK PROPELLER PLATE PLAQUE ARRIÈRE HÉLICE		24,50 €
SF058	EMBRAGUE CLUTCH EMBRAYAGE		54,69 €
SF059	EJE EXCÉNTRICO DE POLEA ECCENTRIC PULLEY SHAFT AXE POULIE EXCENTRIQUE		31,25 €

SF060	RODAMIENTO 6004 (2 UNIDADES) 6004 BEARING (2 UNITIES) ROULEMENT 6004 (2 UNITÉES)	9,22 €
SF061	RODAMIENTO 6202 POLEA PEQUEÑA (2 UNIDADES) SMALL PULLEY 6202 BEARING (2 UNITIES) ROULEMENT 6004 PETITE POULIE (2 UNITÉES)	8,90 €
SF062	CASQUILLO DE EXCÉNTRICA PULLEY SHAFT SPACER RONDELLE AXE POULIE	4,27 €
SF063	CLIP (POLEA) Anillo seeger ø 35 mms. CLIP (PULLEY) Seeger ring ø 35 mms. CLIP (POULIE) Anneau seeger ø 35 mms.	0,47 €
SF064	CLIP (EJE EXCÉNTRICO DE POLEA) Anillo seeger. CLIP (ECCENTRIC AXEL) Seeger ring. CLIP (POULIE) Anneau seeger.	0,47 €
SF065	CLIP (CIGUEÑAL) Anillo seeger CLIP (CRANKSHAFT) Seeger ring CLIP (VILEBREQUIN) Anneau seeger	0,47 €
SF066	SOPORTE HÉLICE PROPELLER PLATE SUPPORT HELICE	24,45 €
SF067	CONTRAPLACA HELICE FRONT PROPELLER PLATE PLAQUE AVANT DE SOUTIENT DE L'HÉLICE	11,33 €
SF068	CORREA 584 584 BELT COURROIE 584	28,13 €
SF069	POLEA GRANDE BIG PULLEY GRANDE POULIE	156,25 €
SF070	ARANDELA PLANA M.8 FLAT WASHER M.8 RONDELLE PLATE M.8	0,47 €
SF071	TORNILLO SUJEC. EXCÉNTRICA PULLEY SHAFT SCREW VIS AXE DE POULIE	0,47 €
SF072	ARANDELA GROW. SUJ. EXCENTRICA GROW PULLEY SHAFT WASHER RONDELLE D'AXE DE POULIE GROW	0,47 €
SF073	ARANDELA ACU. SUJ. EXCÉNTRICA ACU Small washer RONDELLE ACU D'AXE DE POULIE	0,47 €
SF074	TORNILLO SUJ. EXCÉNTRICA M.8 pulley shaft screw m.8 VIS AXE DE POULIE M.8	0,47 €
SF075	TORNILLO AV. DE POLEA M.4 PULLEY SCREW M.4 VIS POULIE M.4	0,47 €
SF076	KIT DE POLEA COMPLETO complete pulley kit kit complete poulie	210,94 €
SF077	MUELLE DE EMBRAGUE CLUTCH SPRING RESSORT D'EMBRAYAGE	0,89 €
SF078	TORNILLO ALLEN EMBRAGUE CLUTCH SCREW VIS D'EMBRAYAGE	0,47 €

SF079	TORNILLO SILENTBLOCK M.6 (2 UNIDADES) SILENTBLOCK M.6 SCREW (2 UNITIES) VIS DE SILENTBLOCK M.6 (2 UNITÉES)	0,95 €
SF080	ARANDELA M.5 (3 UNIDADES) M.5 WASHER (3 UNITIES) RONDELLE M.5 (3 UNITÉES)	1,42 €
SF081	ARANDELA SILENTBLOCK M.6 (3 UNIDADES) SILENTBLOCK M.6 WASHER (3 UNITIES) RONDELLE DE SILENTBLOCK M.6 (3 UNITÉES)	1,42 €
SF082	SILENTBLOCK M.8 (4 UNIDADES) SILENTBLOCK M.8 (4 UNITIES) SILENTBLOCK M.8 (4 UNITÉES)	13,40 €
SF083	SILENTBLOCK M.6 (2 UNIDADES) SILENTBLOCK M.6 (2 UNITIES) SILENTBLOCK M.6 (2 UNITÉES)	6,70 €
SF084	TUERCA ARRANC. AUTOBLOCANTE M.5 (3 UNIDADES) SELF LOCKING NUT M.5 (3 UNITIES) ÉCROU M.5 (3 UNITÉES)	3,48 €
SF085	CUERDA DE ARRANQUE STARTER ROPE CORDE DÉMARREUR	2,97 €
SF086	CLIQET (2 UNIDADES) CLIQET (2 UNITIES) CLIQET (2 UNITÉES)	13,37 €
SF087	MUELLE DE ARRANCADOR STARTER SPRING RESSORT DÉMARREUR	4,84 €
SF088	CASQUILLO DE ARRANCADOR SPACER SÉPARATEUR	4,69 €
SF089	CLIP (CLIQUETS) CLIP (CLIQUETS - PLASTIC HOOK) CLIP (CLIQUETS)	6,64 €
SF090	TORNILLO CARCASA ARRANQUE starter plate screw m.5 VIS dÉmarreur	0,47 €
SF091	POLEA DE ARRANQUE MANUAL PLASTICO PLASTIC MANUAL STARTER PULLEY POULIE PLASTIQUE DÉMARREUR MANUEL	70,31 €
SF092	CARCASA DE ARRANQUE STARTER PLATE CARCASE DÉMARREUR	76,56 €
SF093	CAMPANA ALUMINIO CLIQUETS ALUMINIUM TOOTHED BELL CLOCHE CLIQUETS EN ALUMINIUM	29,69 €
SF094	TORNILLO PLACA ARRANCADOR M.5 (3 UNIDADES) STARTER PLATE SCREW (3 UNITIES) VIS CARCASSE DÉMARREUR (3 UNITÉES)	1,42 €
SF095	ARANDELA PLACA ARRANCADOR (4 UNIDADES) STARTER PLATE WASHER (4 UNITIES) RONDELLE CARCASSE DÉMARREUR (4 UNITÉES)	1,90 €
SF096	CASQUILLO DE ARRANCADOR (3 UNIDADES) SPACER (3 UNITIES) SÉPARATEUR (3 UNITÉES)	14,06 €
SF097	TORNILLO SILENTBLOCK M.8 (4 UNIDADES) SILENTBLOCK M.8 SCREW (4 UNITIES) VIS SILENTBLOCK M.8 (4 UNITÉES)	1,90 €
SF098	TORNILLO PLACA ARRANCADOR (4 UNIDADES) STARTER PLATE SCREW (4 UNITIES) VIS CARCASSE DÉMARREUR (4 UNITÉES)	1,90 €
SF099	PLACA TRASERA BACK STARTER PLATE CARCASSE ARRIÈRE DÉMARREUR	123,44 €

SAFARI125

ENCENDIDO Y ARRANQUE
IGNITION & STARTER
ALLUMAGE ET DEMARREUR

page
1/5

PVP

SF100	TIRADOR DE ARRANCADOR HANDLE FOR MANUAL STARTER POIGNÉE DÉMARREUR MANUEL	1,88 €
SF101	TORNILLO AV. SUJ.PLACA TRASERA M.6 BACK PLATE FIXING SCREW M.6 VIS M.6 CARCASSE ARRIÈRE DU DÉMARREUR	0,47 €
SF102	ARRANCADOR COMPLETO COMPLETE MANUEL STARTER DÉMARREUR MANUEL COMPLET	96,88 €
SF103	KIT ARRANQUE FÁCIL flash starter kit kit flash starter	160,16 €

SAFARI125

TUBO ESCAPE
EXHAUST PIPE
TUBE D'ÉCHAPPEMENT

page
1/3

PVP

SF104	CASQUILLO SEPARADOR ESCAPE EXHAUST SPACER SÉPARATEUR ÉCHAPPEMENT	4,69 €
SF105	TORNILLO SUJ. ESCAPE M.6 (2 UNIDADES) EXHAUST FIXING SCREW M.6 (2 UNITIES) VIS ÉCHAPPEMENT M.6 (2 UNITÉES)	0,95 €
SF106	TORNILLO LARGO ESCAPE M.6 X 45 (6 UNIDADES) ESHAUST LONG SCREW M.6x45 (6 UNITIES) VIS LARGE ÉCHAPPEMENT M.6X45 (6 UNITÉES)	2,85 €
SF107	TUERCA HIERRO AUTOBLOCANTE (6 UNIDADES) IRON SELF LOCKING NUT (6 UNITIES) ÉCROU DE FER (6 UNITÉES)	2,85 €
SF108	ARANDELA GROW. SUJ. ESCAPE M.6 (2 UNIDADES) EXHAUST FIXING WASHER M.6 (2 UNITIES) RONDELLE GROW ÉCHAPPEMENT (2 UNITÉES)	0,95 €
SF109	GOMA DE ABRAZADERA SILENCER BRACE RUBBER BAND LANGUETTE CAOUTCHOUC POUR COLLIER	4,45 €
SF110	CUERPO DE ESCAPE EXHAUST WITHOUT SILENCER POT D'ÉCHAPPEMENT SANS SILENCIEUX	210,94 €
SF111	SILENCIADOR COMPLETO COMPLETE SILENCER SILENCIEUX COMPLET	92,34 €
SF112	RÓTULA DE ESCAPE ROTULAR CONNECTION ROTULE	26,72 €
SF113	TORNILLO DE RÓTULA M.6 (2 UNIDADES) ROTULAR CONNECTION SCREW M.6 (2 UNITIES) VIS M.6 ROTULE (2 UNITÉES)	2,97 €
SF114	JUNTA ESCAPE EXHAUST GASKET JOINT D'ÉCHAPPEMENT	4,16 €
SF115	JUNTA TORICA ESCAPE (VITON) EXHAUST GASKET (VITON) JOINT TORIQUE (VITON)	5,00 €
SF116	ABRAZADERA DEL SILENCIOSO SILENCER METAL BRACE COLLIER POUR SILENCIEUX	7,81 €
SF117	SILENCIOSO COMPLETO COMPLETE SILENCER SILENCIEUX COMPLET	78,12 €

SAFARI125

TUBO ESCAPE
EXHAUST PIPE
 TUBE D'ÉCHAPPEMENT

page
1/3

PVP

SF119	MUELLE TORNILLO ESCAPE EXHAUST SPRING RESSORT D'ÉCHAPPEMENT	1,09 €
SF120	GOMA DE UNIÓN SILENCIADOR SILENCER RUBBER HOISING GOMME UNION SILENCIEUX	11,88 €
SF121	ARANDELA GROWER M.8 SILENCIADOR SILENCER GROWER WASHER M.8 RONDELLE GROWER SILENCIEUX ÉCHAPPEMENT M.8	0,47 €
SF122	ARANDELA PLANA SILENCIADOR M.8 SILENCER FLAT WASHER M.8 RONDELLE SILENCIEUX ÉCHAPPEMENT M.8	0,47 €
SF123	TORNILLO SILENCIADOR M.8 SILENCER SCREW M.8 VIS SILENCIEUX COMPLET M.8	0,47 €
SF124	TUERCA BOCA SCAPE M.6 (2 UNIDADES) EXHAUST ENTRY NUT M.6 (2 UNITIES) ECROU ÉCHAPPEMENT M.6 (2 UNITÉES)	0,95 €
SF125	ARANDELA BOCA ESCAPE M.6 (2 UNIDADES) EXHAUST ENTRY WASHER M.6 (2 UNITIES) RONDELLE ÉCHAPPEMENT M.6 (2 UNITÉES)	0,95 €
SF126	TUERCA DE SILENCIADOR M.8 SILENCER NUT M.8 ECROU SILENCIEUX M.8	0,47 €
SF127	ESCAPE COMPLETO COMPLETE EXHAUST POT D'ÉCHAPPEMENT COMPLET	281,25 €
SF128	ARANDELA SUJ. ESCAPE M.6 (2 UNIDADES) EXHAUST FIXING WASHER M.6 (2 UNITIES) RONDELLE ECHAPPEMENT M.6 (2 UNITÉES)	0,95 €

MOSTER185 CLASSIC

BLOQUE MOTOR

MOTOR BLOCK

BLOQUE MOTEUR

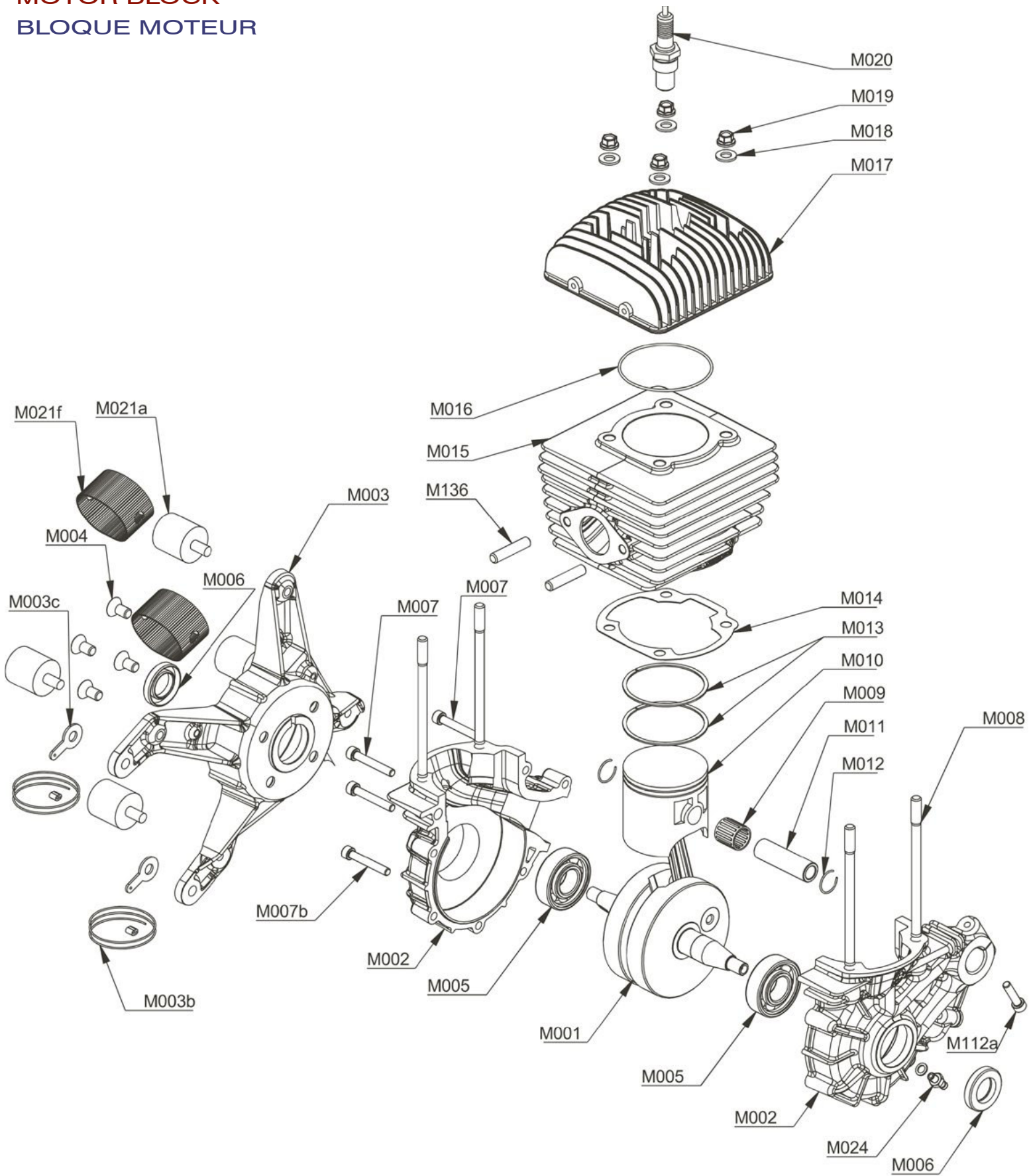

MOSTER185 CLASSIC

ARRANQUE
STARTER
DEMARREUR

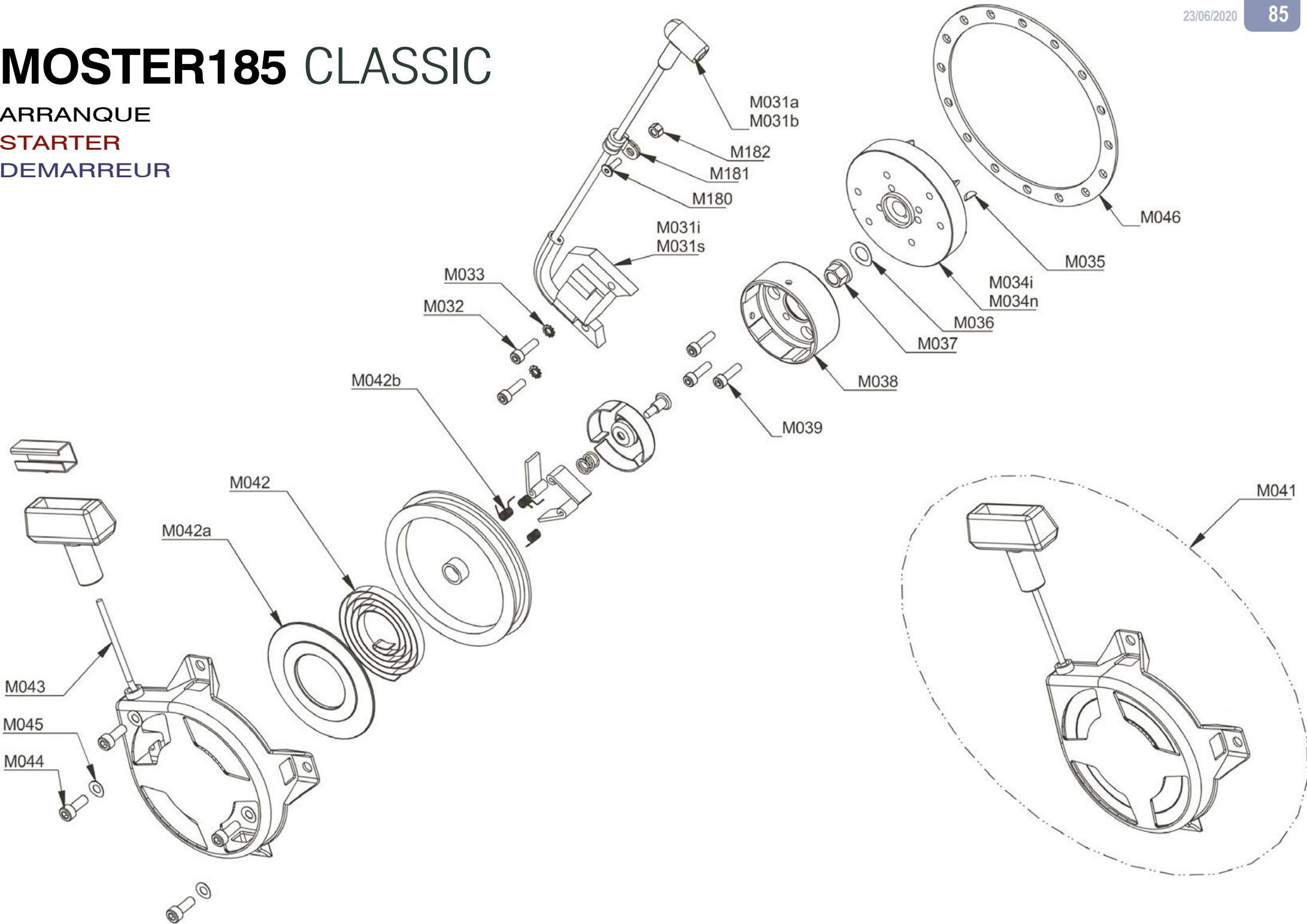

MOSTER185 CLASSIC

REDUCTORA
REDUCTOR
REDUCTEUR

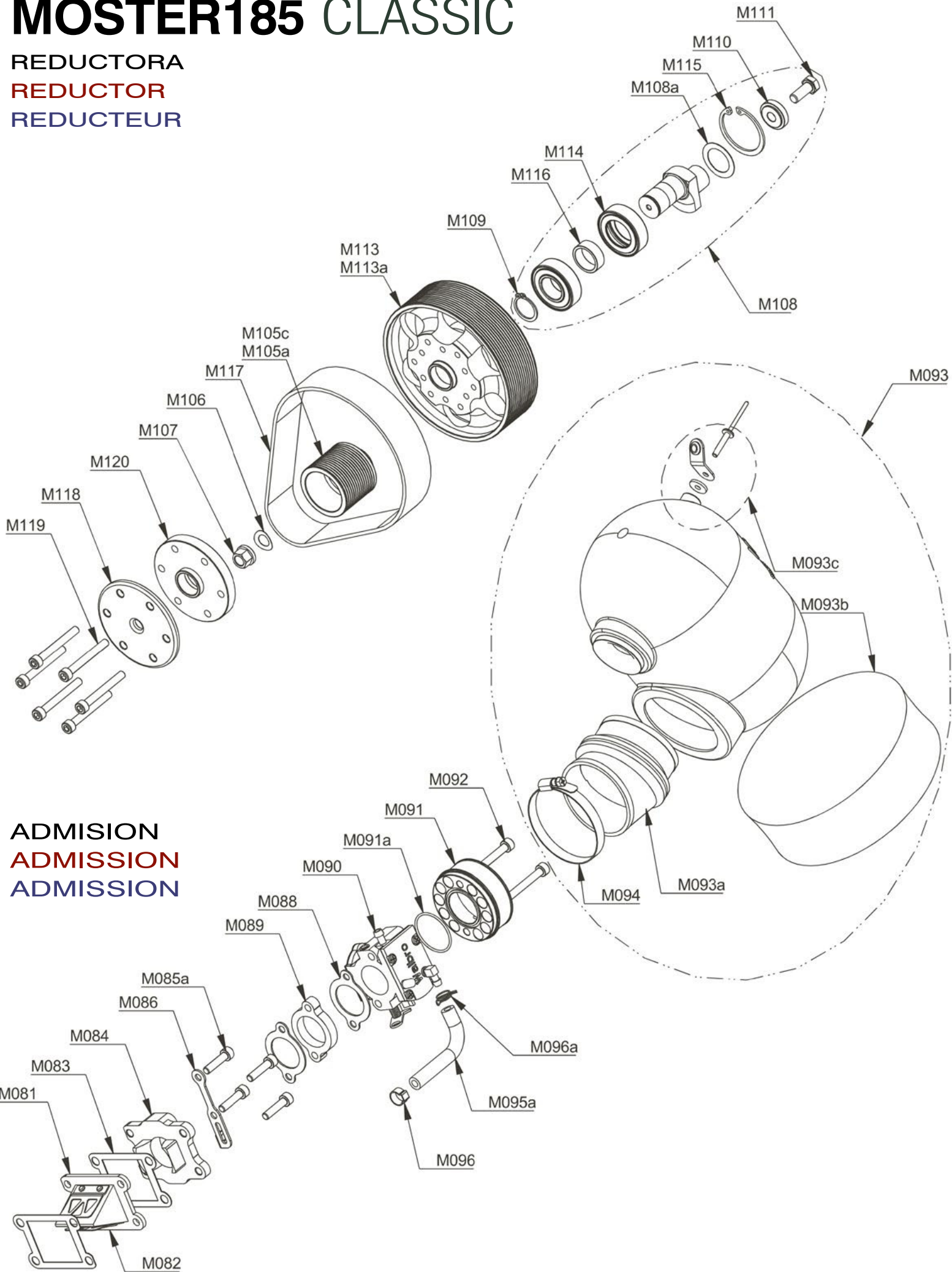

ADMISION
ADMISSION
ADMISSION

MOSTER185 CLASSIC

ESCAPE

EXHAUST PIPE

ECHAPPEMENT

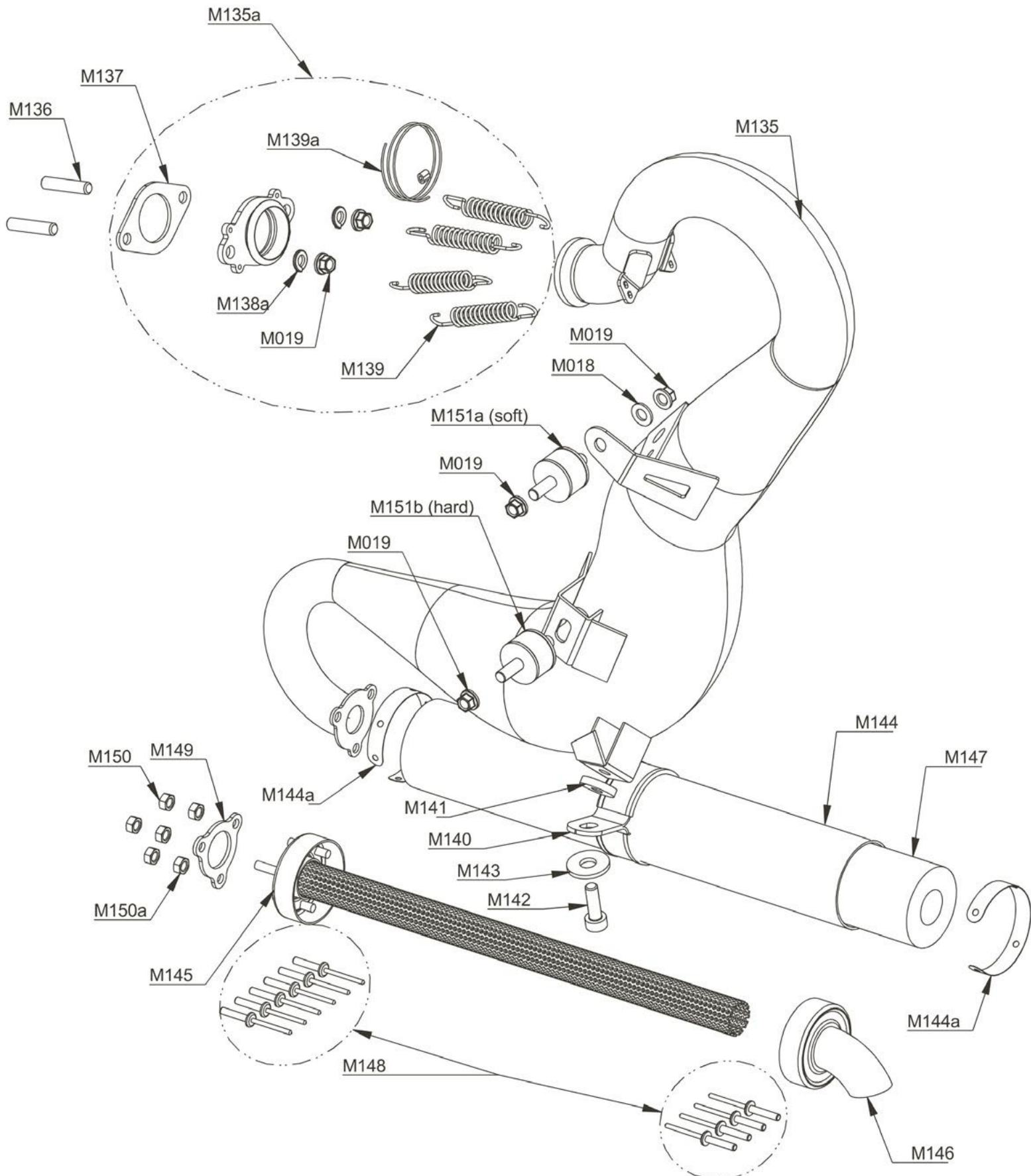

MOSTER185 PLUS MY19

BLOQUE MOTOR
MOTOR BLOCK
BLOQUE MOTEUR

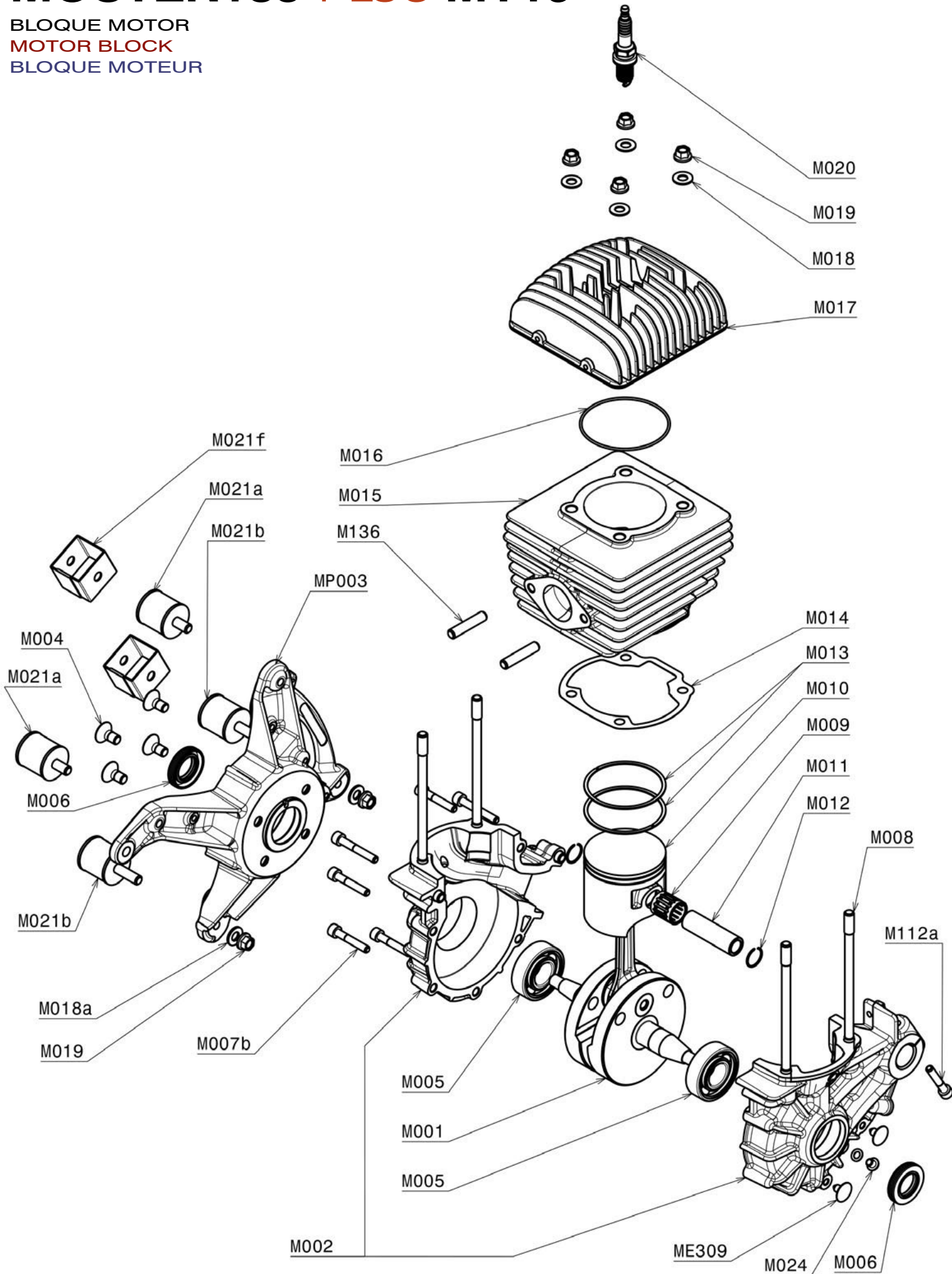

MOSTER185 PLUS MY19

ARRANQUE
STARTER
DEMARREUR

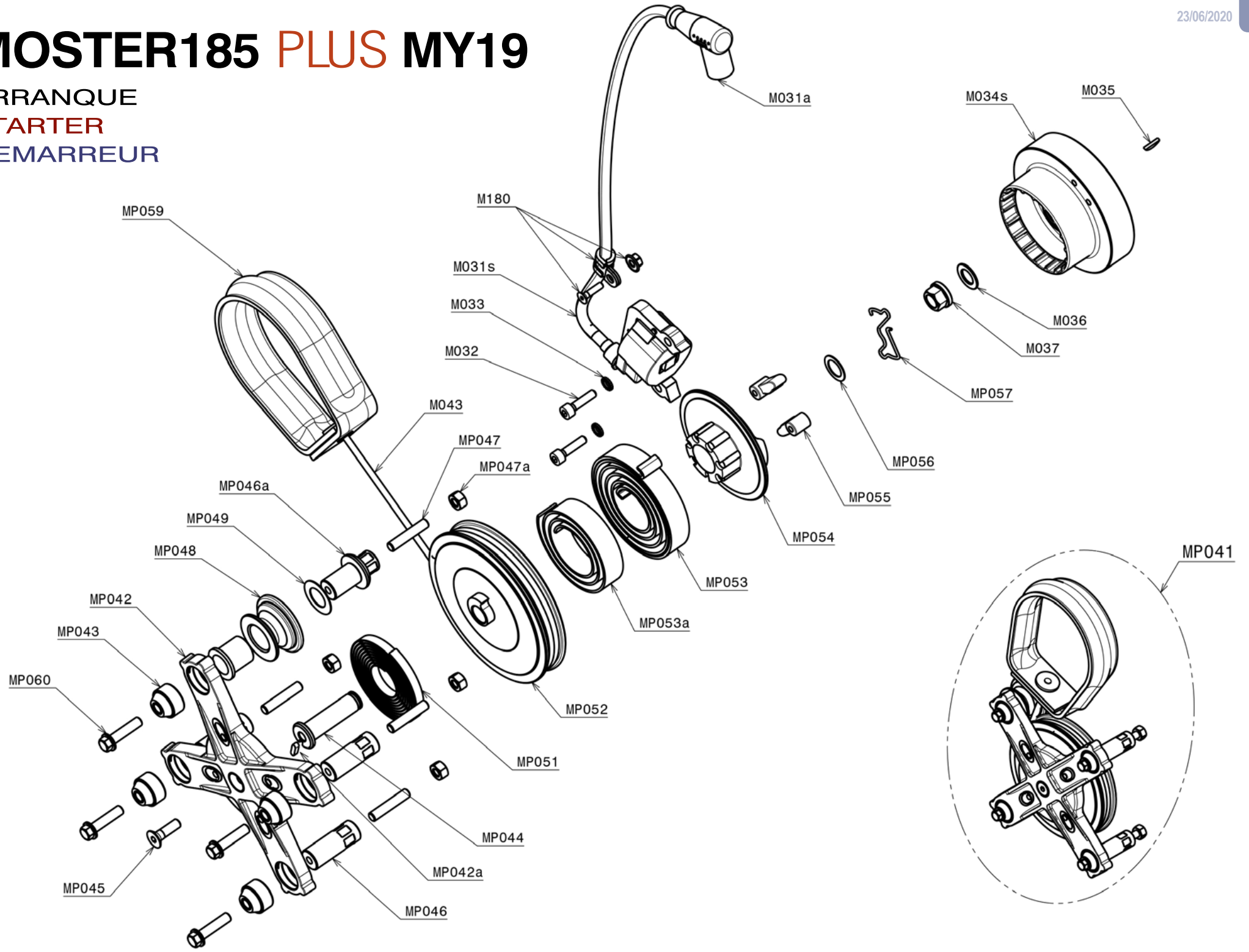

MOSTER185 PLUS MY19

REDUCTORA
REDUCTOR
REDUCTEUR

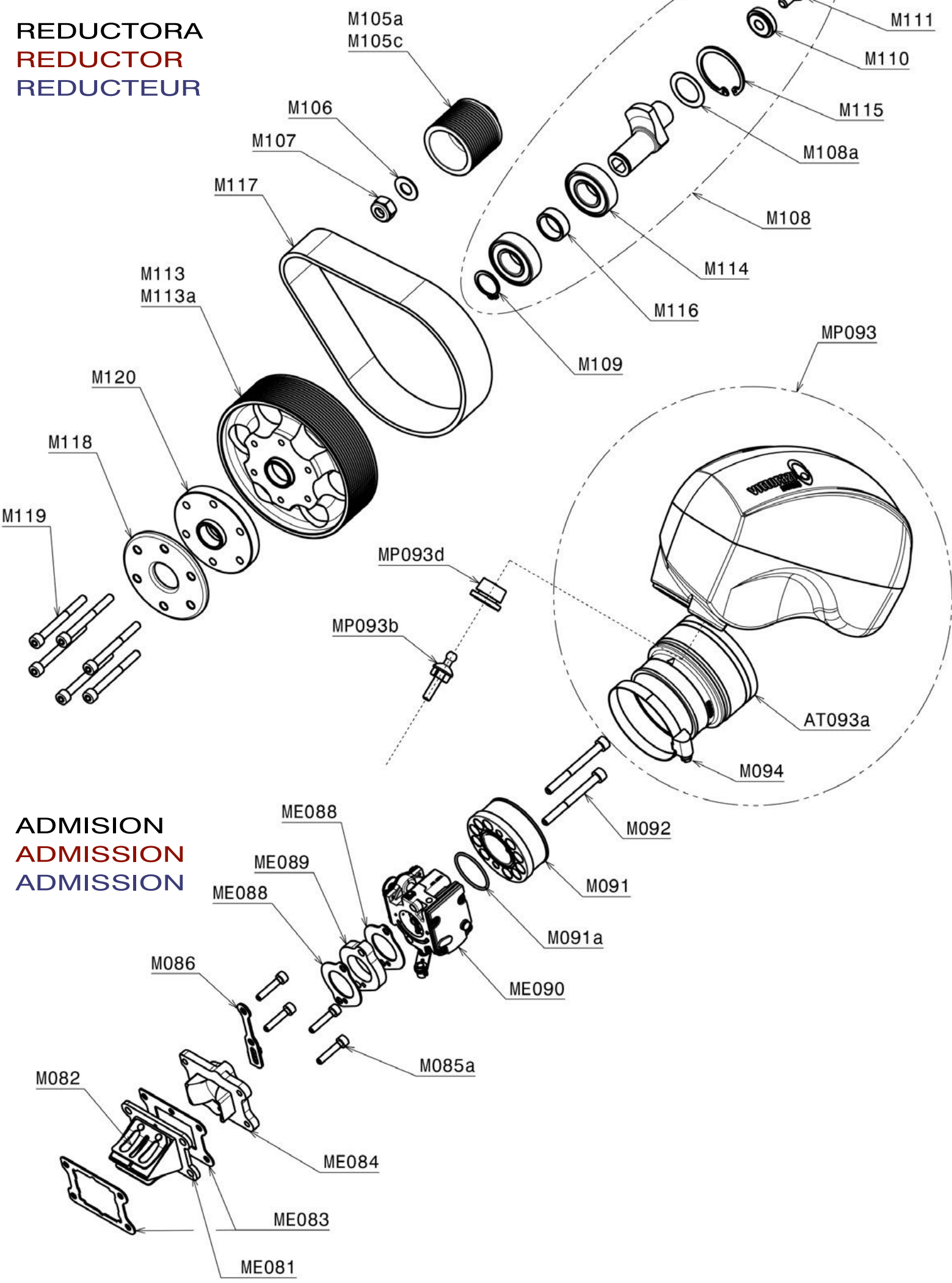

ADMISION
ADMISSION
ADMISSION

MOSTER185 PLUS MY19

ESCAPE EXHAUST PIPE ECHAPPEMENT

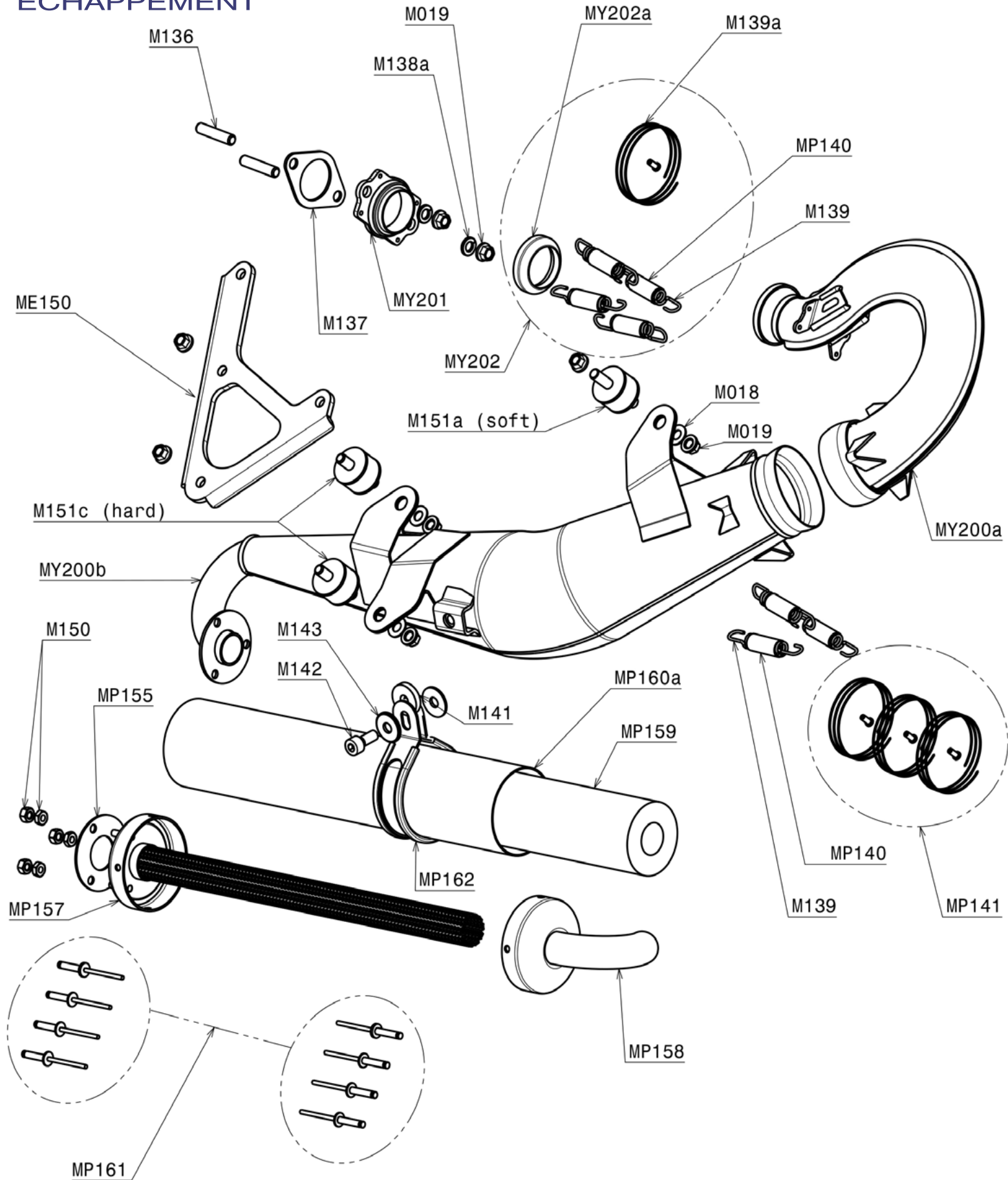

MOSTER185 DUAL MY19

BLOQUE MOTOR
MOTOR BLOCK
 BLOQUE MOTEUR

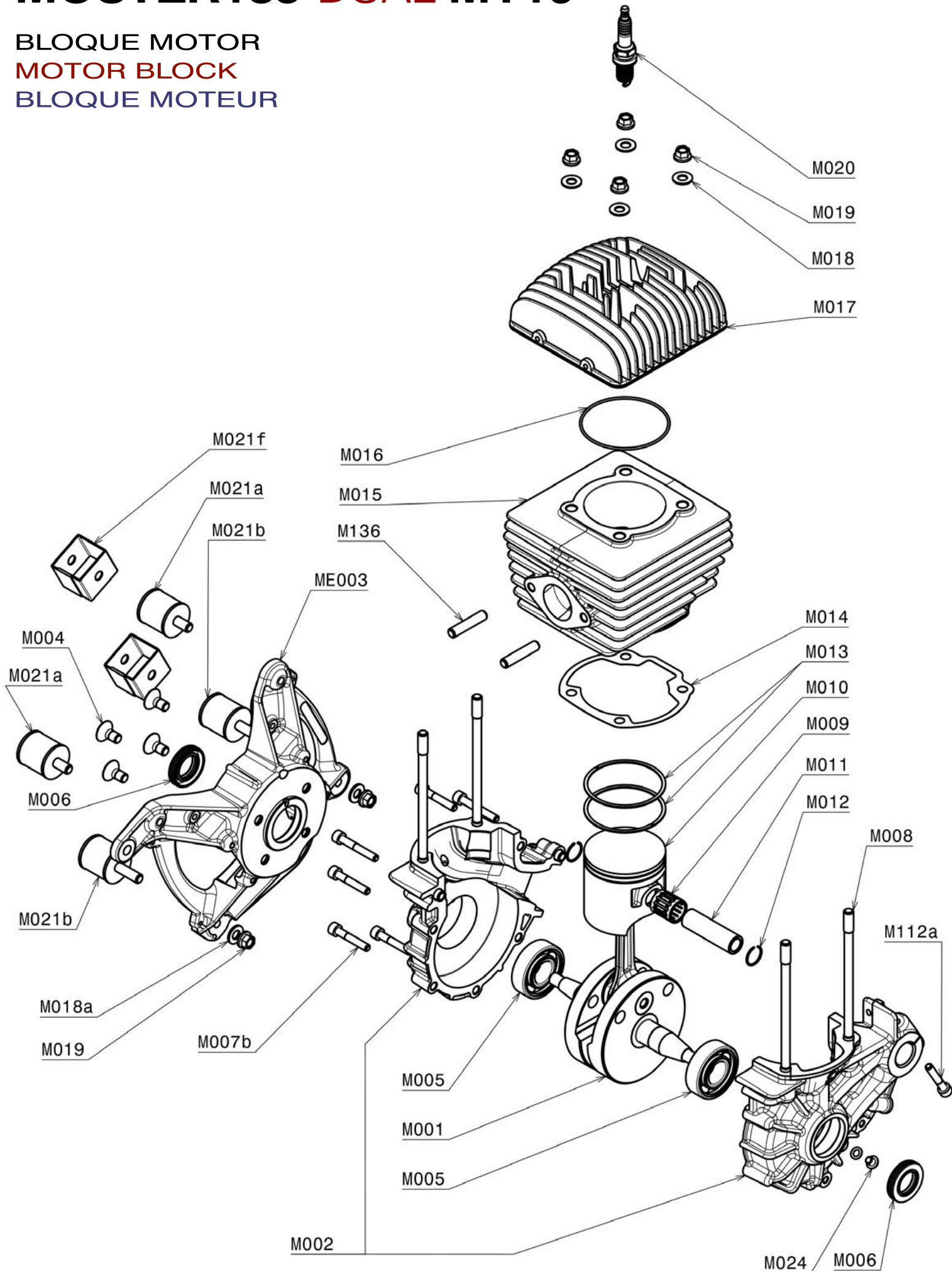

MOSTER185 DUAL MY19

ARRANQUE
STARTER
DEMARREUR

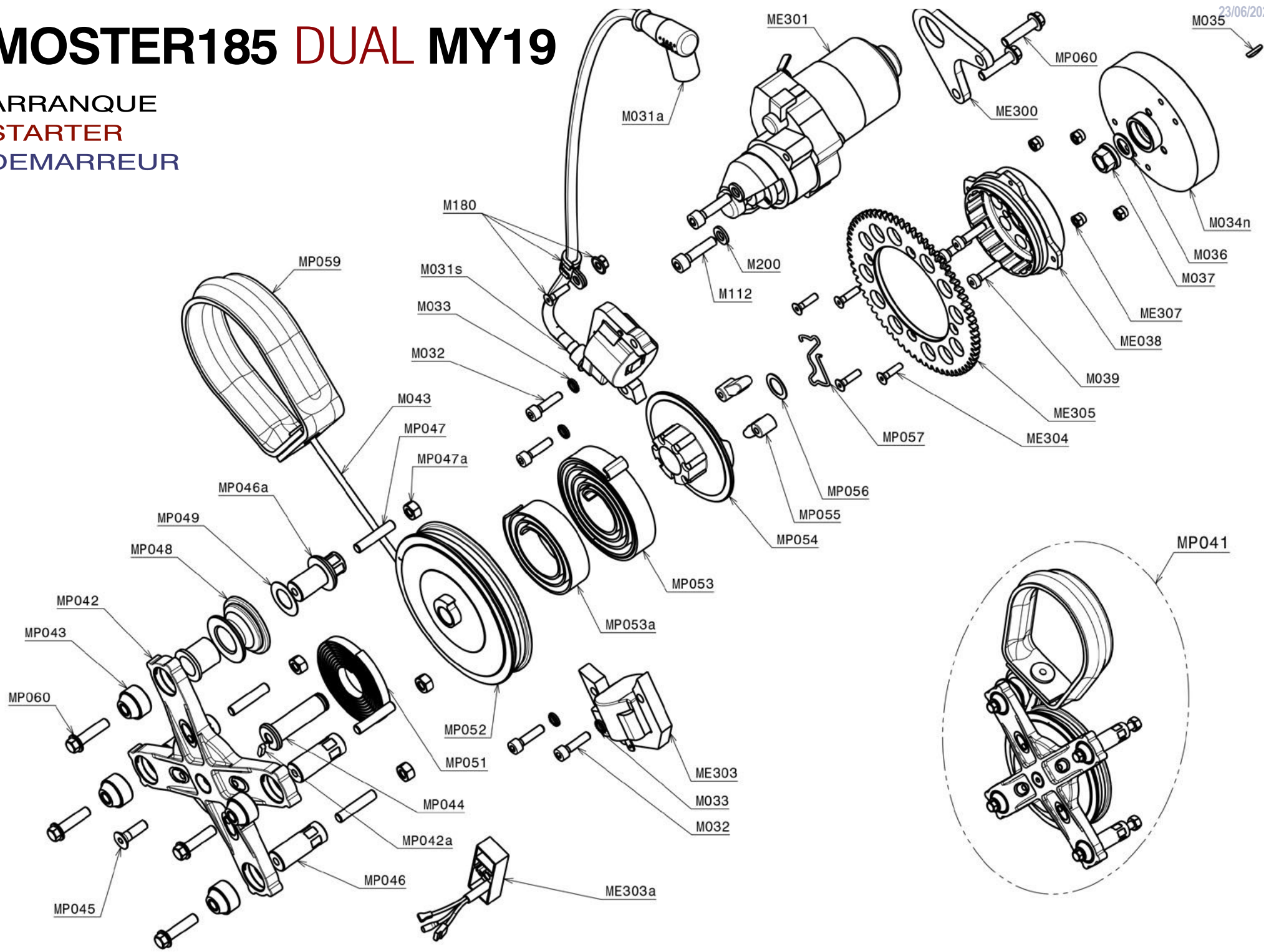

MOSTER185 DUAL MY19

REDUCTORA
REDUCTOR
REDUCTEUR

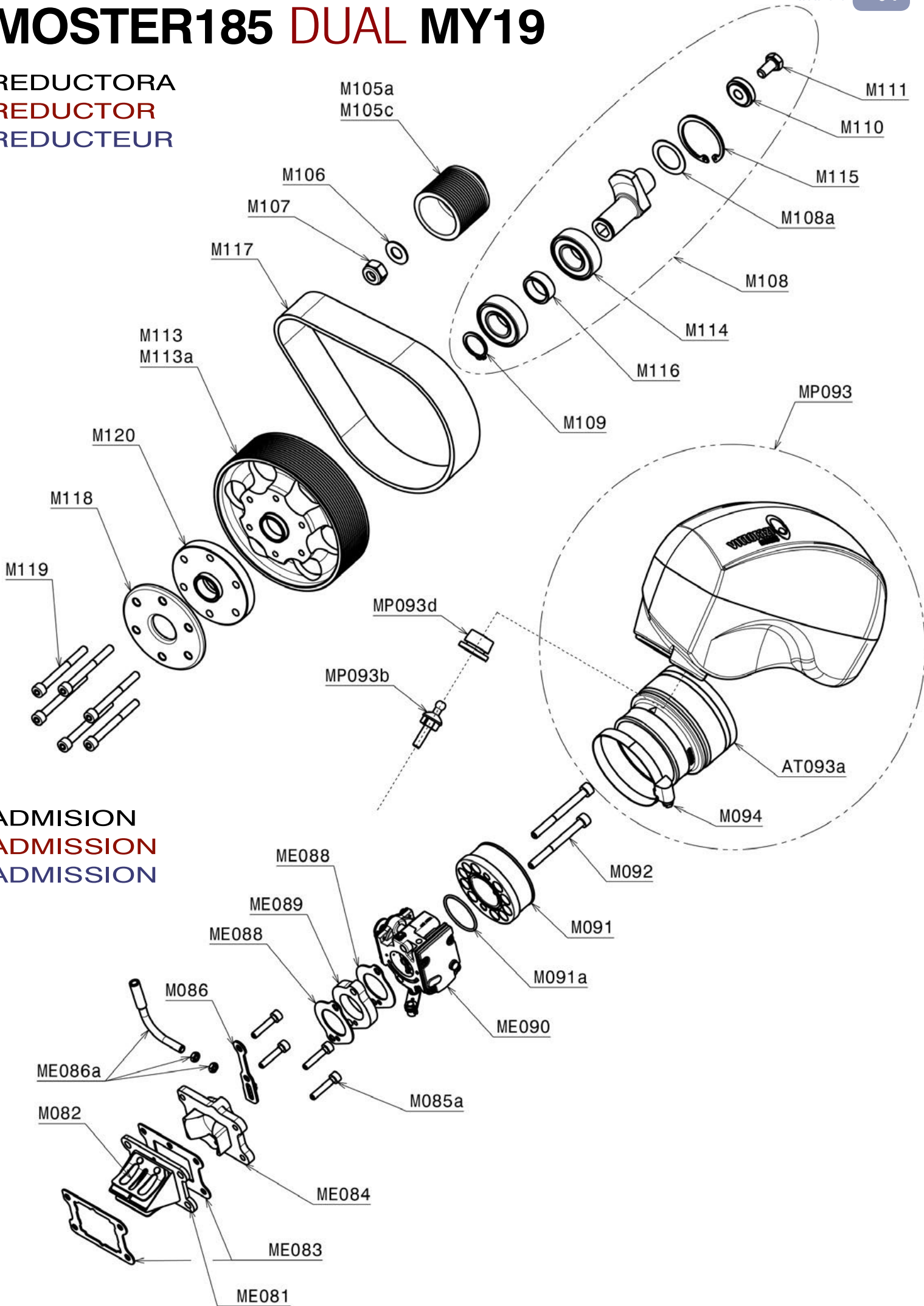







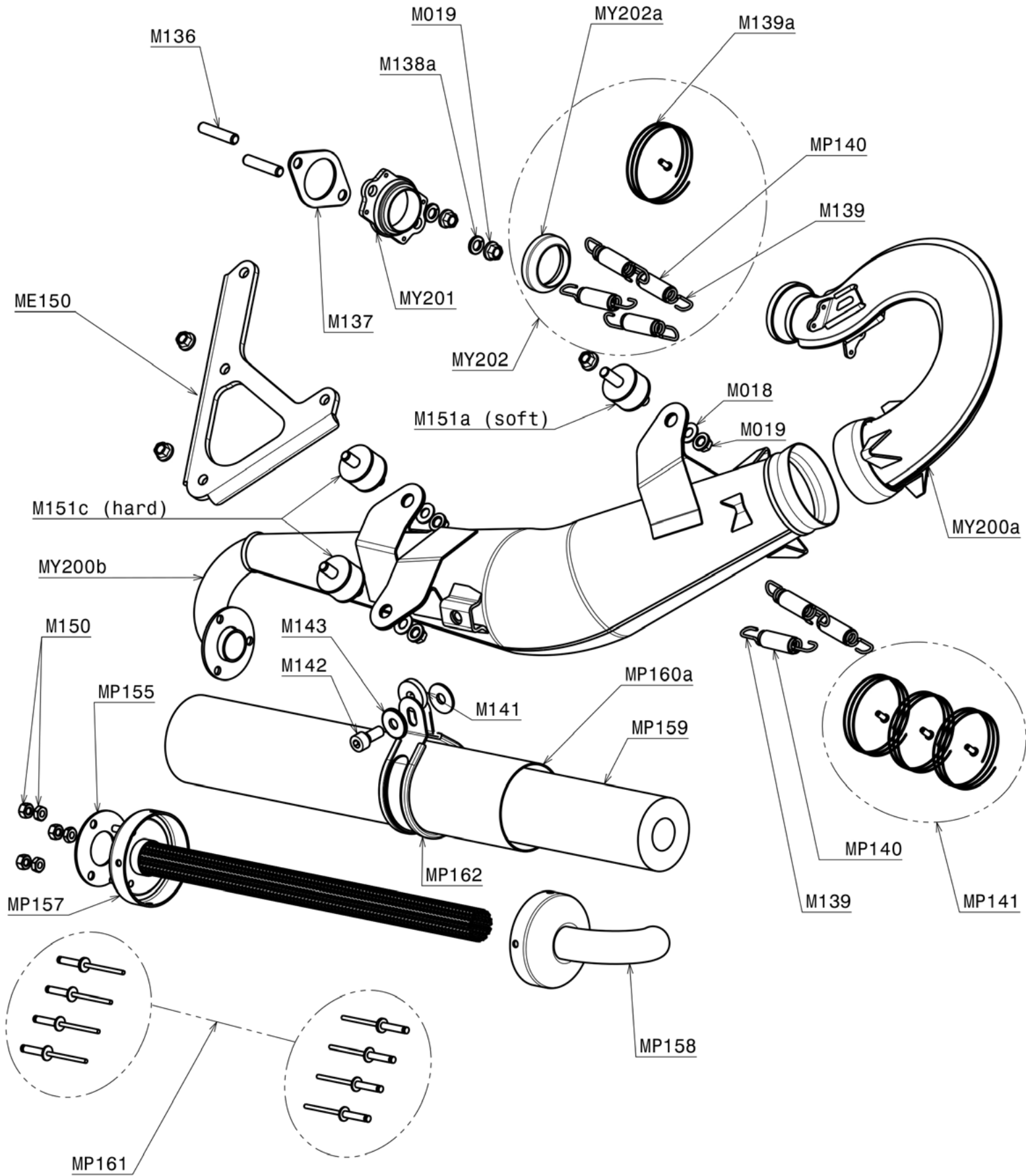



ADMISION
ADMISSION
ADMISSION

MOSTER185 DUAL MY19

ESCAPE
EXHAUST PIPE
ECHAPPEMENT





	VM001	CIGUEÑAL CON VIELA CRANKSHAFT WITH PUSH ROD VILLEBREQUIN AVEC BIELE		218,75 €
	VMP001	CIGUEÑAL CON VIELA CRANKSHAFT WITH PUSH ROD VILLEBREQUIN AVEC BIELE	Includes: M036 - M037	243,75 €
	VM002	BLOQUE CÁRTER MOTOR, NEGRO ENGINE CARTER BLOCK, BLACK BLOC MOTEUR NOIR	Includes: M004 - M007B - M008 - M024 - M085A - ME309	220,00 €
	VM003	SOPORTE CARTER MOTOR ENGINE CARTER SUPPORT WITH OIL SEAL SUPPORT CARTER MOTEUR		101,25 €
	VMP003	SOPORTE CÁRTER MOTOR, NEGRO (VERSION ARRANQUE MANUAL) ENGINE CARTER SUPPORT, BLACK (MANUAL START VERSION) SUPPORT MOTEUR, NOIR (VERSION À DÉMARRAGE MANUEL)	Includes: M004 - M006	103,75 €
	VME003	SOPORTE CÁRTER MOTOR, NEGRO (VERSION ARRANQUE MANUAL) ENGINE CARTER SUPPORT, BLACK (MANUAL START VERSION) SUPPORT MOTEUR, NOIR (VERSION À DÉMARRAGE MANUEL)	Includes: M004 - M006	116,25 €
	VM003a	REFUERZO PARA SOPORTE CÁRTER MOTOR (SET DE 2) REINFORCEMENTS FOR ENGINE CARTER SUPPORT (SET OF 2) RENFORCEMENT POUR LE SUPPORT DE CARTER MOTEUR (SET DE 2)		3,00 €
	VM003b	CABLE DE SEGURIDAD 26CM Y REMACHES (SET DE 2) SAFETY CABLES 26 CM AND STEEL CRIMPS (SET OF 2) CÂBLES DE SÉCURITÉ 26 CM ET SERRE-CÂBLES EN ACIER (SET DE 2)		2,50 €
	VM003c	PLETINA REFUERZO SOPORTE CARTER SAFETY CABLE FIXING PLATE RENFORCEMENT DE SOUTIEN MOTEUR CARTER		1,50 €
	VM004	TORNILLO 8 X 16 MM TSEI DIN 7991 (SET DE 4) BOLT 8 X 16 MM TSEI DIN 7991 (SET OF 4) VIS 8 X 16 MM TSEI DIN 7991 (SET DE 4)		2,50 €
	VM005	RODAMIENTO 47/20/14 MM - C3 (SET DE 2) BEARING 47/20/14 MM - C3 (SET OF 2) ROULMENT 47/20/14 MM - C3 (SET DE 2)		20,00 €
	VM006	RETENES 20/30/7 MM (SET DE 2) OIL SEALS VITON 20/30/7 MM (SET OF 2) JJOINTS SPY 20/30/7 MM (SET OF 2)		10,00 €
	VM007	TORNILLO 6 X 40 MM TCEI DIN912, (SET DE 6) BOLT 6 X 40 MM TCEI DIN912, (SET OF 6) VIS 6 X 40 MM TCEI DIN912, (SET DE 6)		1,88 €
	VM007b	TORNILLO 6 X 35 MM TCEI (SET DE 5) Y TORNILLO 6 X 40 MM TCEI DIN912 (SET DE 2) BOLT 6 X 35 MM TCEI (SET OF 5) AND BOLT 6 X 40 MM TCEI DIN912, (SET OF 2) VIS 6 X 35 MM TCEI (SET DE 5) ET VIS 6 X 40 MM TCEI DIN912, (SET DE 2)		2,19 €
	VM008	ESPÁRRAGOS CILINDRO 8 X 148. 4 Unidades 8 X 148 CYLINDER STUD. 4 Unities AXES CYLINDRE 8 X 148. 4 Unitées		20,00 €
	VM009	COJINETE PISTON PISTON BEARING ROULEMENT PISTON		15,00 €
	VM010	PISTON COMPLETO ø 66 (SEGMENTO Y BULON) A / B / C / D / E COMPLET PISTON ø 66 (SEGMENT & BOULON) A / B / C / D / E PISTON COMPLET ø 66 (SEGMENT ET BOULON) A / B / C / D / E		116,87 €
	VM011	BULON DE PISTON ø 16 ø 16 PISTON PIN AXE DE PISTON ø 16		6,87 €
	VM012	CLIPS DE BOULON (SET DE 2) PIN LOCK RINGS (SET OF 2) CLIPS DE BOULONS (SET DE 2)		2,50 €
	VM013	SEGMENTO DE PISTON GS10 CROMADO (SET OF 2) PISTON RING GS10 CHROMED (SET OF 2) SEGMENT DU PISTON GS10 CHROMED (SET OF 2)		45,00 €
	VM014	KIT JUNTAS CILINDRO. 5 Unidades (x2 - 0,2 mm. / x2 - 0,3 mm / 0,5 mm) CYLINDER GASKET. 5 Unities (x2 - 0,2 mm. / x2 - 0,3 mm / 0,5 mm) JOINT CYLINDRE. 5 Unitées (x2 - 0,2 mm. / x2 - 0,3 mm / 0,5 mm)		5,63 €









	VM015	CILINDRO CROMADO Ø 66 MM A / B / C CYLINDER CHROMED Ø 66 MM A / B / C CILINDRE CHROMÉ Ø 66 MM A / B / C	Includes: M019 - M136 - M137 - M138A	325,00 €
	VM016	JUNTA TORICA DE CULATA Ø 69,57 X 1,78 MM. CYLINDER HEAD GASKET Ø 69,57 X 1,78 MM. JOINT TORRIQUE DE CULASSE Ø 69,57 X 1,78 MM		2,50 €
	VM017	CULATA CYLINDER HEAD CULASSE	Includes: M016	77,50 €
	VM018	ARANDELA Ø 8 X 16 MM DIN 125A (SET DE 4) WASHER Ø 8 X 16 MM DIN 125A (SET OF 4) RONDELLE Ø 8 X 16 MM DIN 125A (SET OF 4)		1,25 €
	VM018a	ARANDELA Ø 8 X 18 MM DIN 125A, NEGRO (SET DE 2) WASHER Ø 8 X 18 MM DIN 125A, BLACK (SET OF 2) RONDELLE Ø 8 X 18 MM DIN 125A, NOIR (SET OF 2)		0,63 €
	VM019	TUERCA DE COBRE AUTOBLOCANTE DE ALTA TEMPERATURA 8 X 1,25 MM (SET DE 4) COPPER LOCK NUT HIGH TEMPERATURE 8 X 1,25 MM (SET OF 4) ECROUS DE CUIVRE AUTO BLOQUANT HAUT TEMPERATURE 8 X 1,25 MM (SET DE 4)		5,00 €
	VM020	BUJIA BR9ES SPARK PLUG BR9wES BOUGIE BR9ES		7,50 €
	VM021	SILENTBLOC 30 X 30 MM - M8 X 20 MM (SET OF 2) ANTIVIBRATION MOUNT 30 X 30 MM - M8 X 20 MM (SET OF 2) SILENTBLOCK 30 X 30 MM - M8 X 20 MM (SET OF 2)	Includes: M018 - M019	11,25 €
	VM021a	SILENTBLOC 30 X 15 MM - M8 X 15 MM (SET OF 2) ANTIVIBRATION MOUNT 30 X 30 MM - M8 X 15 MM (SET OF 2) SILENTBLOCK 30 X 30 MM - M8 X 15 MM (SET OF 2)	Includes: M018a - M019	10,00 €
	VM021b	SILENTBLOC 30 X 15 MM - M8 X 25 MM (SET OF 2) ANTIVIBRATION MOUNT 30 X 30 MM - M8 X 25 MM (SET OF 2) SILENTBLOCK 30 X 30 MM - M8 X 25 MM (SET OF 2)	Includes: M018a - M019	11,25 €
	VM021f	CINTAS DE SEGURIDAD (SET OF 2) SAFETY BANDS (SET OF 2) BANDE DE SECURITY (SET OF 2)		3,75 €
	VM024	TORNILLO 6 X 6 TBEI DIN 7380 Y ARANDELA DE COBRE BRASS JUNCTION, BOLT 6 X 6 MM TBEI DIN 7380 AND COPPER WASHER VIS DE 6 X 6 TBEI DIN 7380 ET RONDELLE DE CUIVRE		3,13 €
	VM031a	PIPA DE BUJIA MARCA SELETTRA SPARK PLUG CAP BRAND SELETTRA CAPUCHON DE BOUGIE MARK SELETTRA		4,40 €
	VM031b	PIPA DE BUJIA MARCA IDM SPARK PLUG CAP BRAND IDM CAPUCHON DE BOUGIE MARK IDM		4,40 €
	VM031i	BOBINA MARCA IDM ELECTRONIC IGNITION BRAND IDM BOBINE MARK IDM	Includes: M031b - M032 - M033	50,00 €
	VM031s	BOBINA MARCA SELETTRA ELECTRONIC IGNITION BRAND SELETTRA BOBINE MARK SELETTRA	Includes: M031a - M032 - M033	50,00 €
	VM032	TORNILLO 5 X 20 MM TCEI DIN912, (SET DE 2) BOLT 5 X 20 MM TCEI DIN912, (SET OF 2) VIS 5 X 20 MM TCEI DIN912, (SET DE 2)		0,63 €
	VM033	ARANDELA DENTADA Ø 5 MM DIN 6798A (SET DE 2) LOCK WASHER TOOTED Ø 5 MM DIN 6798A (SET OF 2) RONDELLE DENTÉE Ø 5 MM DIN 6798A (SET DE 2)		0,63 €
	VM034i	VOLANTE ENCENDIDO MARCA IDM FLYWHEEL BRAND IDM VOLANT MAGNETIQUE MARK IDM		82,50 €
	VM034s	VOLANTE MAGNÉTICO CON POLEA DENTADA INCORPORADA (SELETTRA) FLYWHEEL (SELETTRA) WITH ALUMINUM TOOTHED PULLEY INCORPORATED VOLANT MAGNÉTIQUE AVEC POULIE DENTÉE (SELETTRA)		82,50 €
	VM034n	VOLANTE ENCENDIDO MARCA SELETTRA FLYWHEEL BRAND SELETTRA VOLANT MAGNETIQUE MARK SELETTRA		82,50 €



	VM035	CHAVETA 3 X 3,7 MM DIN 6888 (SET DE 2) KEY-HOLE TANG 3 X 3,7 MM DIN 6888 (SET OF 2) CLAVETTE 3 X 3,7 MM DIN 6888 (SET DE 2)		2,50 €
	VM036	ARANDELA ONDULADA MUELLE Ø 10 EST. 18 MM DIN137B ONDULATED SPRING WASHER Ø 10 EST. 18 MM DIN137B RONDELLE ONDULÉ Ø 10 EST. 18 MM DIN137B		0,63 €
	VM037	TUERCA ESCALONADA 10 X 1.25 MM NUT WITH FLANGE 10 X 1.25 MM ÉCROU 10 X 1,25 MMS		2,50 €
	VM038	CAMPANA ALUMINIO VERSIÓN ARRANQUE MANUAL ALUMINUM TOOTHED PULLEY, MANUAL START VERSION CLOCHE ALUMINIUM VERSION DÉMARRAGE MANUEL	Includes: M039	33,13 €
	VMP038	CAMPANA ALUMINIO VERSIÓN ARRANQUE MANUAL ALUMINUM TOOTHED PULLEY, MANUAL START VERSION CLOCHE ALUMINIUM VERSION DÉMARRAGE MANUEL	Includes: M039	33,13 €
	VME038	POLEA DE ALUMINIO DENTADA, VERSIÓN ARRANQUE ELECTRICO ALUMINUM TOOTHED PULLEY, ELECTRIC STARTER VERSION POULIE EN ALUMINIUM DENTELÉ, VERSION À DÉMARRAGE ÉLECTRIQUE	Includes: M039	38,12 €
	VM039	TORNILLO 5 X 20 MM TCEI 10.9 DIN 7984 (SET DE 3) BOLT 5 X 20 MM TCEI 10.9 DIN 7984 (SET OF 3) VIS 5 X 20 MM TCEI 10.9 DIN 7984 (SET DE 3)		0,94 €
	VM041	ARRANQUE MANUAL COMPLETO PULL STARTER COMPLETE DÉMARREUR MANUEL COMPLETE		86,25 €
	VMP041	ARRANQUE MANUAL COMPLETO PULL STARTER COMPLETE DÉMARREUR MANUEL COMPLETE		225,00 €
	VM042	MUELLE DE ARRANQUE PULL START SPRING RESSORT DE DÉMARREUR		8,75 €
	VMP042	SOPORTE ARRANQUE CON SILENTBLOCKS MONTADOS STARTER STRUCTURE WITH ASSEMBLED ANTIVIBRATION MOUNTS SUPPORT DE DÉMARREUR AVEC LES SILENTBLOCKS MONTÉS	Includes: MP044	61,25 €
	VM042a	SEPARADOR DE PLASTICO DEL ARRANQUE PLASTIC SPACER FOR PULL STARTER PIECE PLASTIQUE DEMARREUR		5,87 €
	VM042b	MUELLES CLIQUET. 1 Ud CLIQUET SPRINGS 1 Ut RESSORTS CLIQUET. 1 Ut		3,75 €
	VM043	CUERDA ARRANQUE 2,2 m. STARTER ROPE 2,2 m. CORDE DÉMARREUR 2,2 m.		3,75 €
	VMP043	SILENTBLOCKS PARA ARRANQUE 20 X 14 MM (SET DE 4) ANTIVIBRATION MOUNT FOR STARTER 20 X 14 MM (SET OF 4) SILENTBLOCKS POR DÉMARREUR 20 X 14 MM (SET DE 4)		15,00 €
	VM044	TORNILLO 6 x 14 mms TCEI . 1 Ud BOLT 6 x 14 mms TCEI 1 Ut VIS 6 x 14 mms TCEI . 1 Ut		0,32 €
	VMP044	PIN CENTRAL DE ARRANQUE STARTER CENTRAL PIN GOUPILLE CENTRALE DE DÉMARREUR	Includes: MP060- MP045	10,63 €
	VM045	ARANDELA ONDULADA Ø 6 MM DIN137B (SET OF 4) WASHER Ø 6 MM CORRUGATED DIN137B (SET OF 4) RONDELLE ONDULÉ Ø 6 MM DIN137B (SET OF 4)		1,25 €
	VMP045	TORNILLO 6 X 20 MM TSEI DIN 7991 BOLT 6 X 20 MM TSEI DIN 7991 VIS 6 X 20 MM TSEI DIN 7991		0,63 €
	VM046	SOPORTE ARRANQUE MANUAL MANUAL STARTER SUPPORT SUPPORT DÉMARREUR MANUEL		12,50 €
	VMP046	SEPARADOR ALUMINIO, NARANJA (SET DE 3) ALUMINUM SPACER, ORANGE (SET OF 3) SÉPARATEUR EN ALUMINIUM, ORANGE (SET DE 3)	Includes: MP047 - MP047A	16,88 €





	VMP046a	SEPARADOR ALUMINIO PARA POLEA, NARANJA ALUMINUM SPACER WITH PULLEY SEAT, ORANGE SÉPARATEUR EN ALUMINIUM POUR POULIE, ORANGE	Includes: MP047 - MP047A	8,13 €
	VMP047	ESPÁRRAGO INOX 6 X 30 MM DIN 913 (SET DE 4) STUDS INOX 6 X 30 MM DIN 913 (SET OF 4) GOUJON INOX 6 X 30 MM DIN 913 (SET DE 4)		2,50 €
	VMP047a	TUERCA AUTOBLOCANTE 6MA DIN 980 (SET DE 4) LOCK NUT 6MA DIN 980 (SET OF 4) ÉCROU AUTOBLOQUANT 6MA DIN 980 (SET DE 4)		1,25 €
	VMP048	POLEA DE ALUMINIO PARA CUERDA, NEGRO ROPE PASSING ALUMINUM PULLEY, BLACK POULIE PASSE-CORDE EN ALUMINIUM, NOIR	Includes: MP049	13,75 €
	VMP049	ARANDELA DE CALADO 14 X 24 MM - 0,3/0,5 MM DIN 988PS (SET DE 2) SHIM WASHER 14 X 24 MM - 0,3/0,5 MM DIN 988PS (SET OF 2) RONDELLE DE CALAGE 14 X 24 MM - 0,3/0,5 MM DIN 988PS (SET DE 2)		2,50 €
	VMP051	MUELLE POLEA ARRANQUE RECOIL SPRING RESSORT POULIE DÉMARREUR		8,75 €
	VMP052	POLEA DE PLÁSTICO CON MUELLE FLASH STARTER PLASTIC PULLEY WITH ASSEMBLED EASY START SPRING POULIE EN PLASTIQUE AVEC RESSORT DE FLASH STARTER		78,13 €
	VMP053	MUELLE FLASH STARTER EASY START SPRING RESSORT FLASH STARTER	Includes: MP053A	25,70 €
	VMP053a	CINTA DE MUELLE FLASH STARTER STRAPING BAND BANDE POUR RESSORT FLASH STARTER		1,87 €
	VMP054	SOPORTE CLIQUET PLASTIC HOOK HOUSING SUPPORT CLIQUET	Includes: MP055- MP056 - MP057	37,50 €
	VMP055	CLIQUET (SET DE 2) PLASTIC HOOKS (SET OF 2) CLIQUETS (SET DE 2)		7,50 €
	VMP056	ARANDELA DE CALADO 12 X 18 MM - 0,2/0,3/0,5/1,0 MM DIN 988PS (SET OF 6) SHIM WASHER 12 X 18 MM - 0,2/0,3/0,5/1,0 MM DIN 988PS (SET OF 6) RONDELLE DE CALASE 12 X 18 MM - 0,2/0,3/0,5/1,0 MM DIN 988PS (SET OF 6)		5,00 €
	VMP057	CLIP DE CLIQUETS ELASTIC RING FOR HOOKS CLIP DE CLIQUETS		3,75 €
	VMP059	ASA ARRANQUE MANUAL MANUAL STARTER HANDLE POIGNÉE DEMARREUR MANUEL		18,75 €
	VMP060	TORNILLO 6 X 25 MM TEF (SET DE 4) BOLT 6 X 25 MM TEF (SET OF 4) VIS 6 X 25 MM TEF (SET DE 4)		2,50 €
	VM081	CAJA DE LAMINAS REED VALVE COMPLETE BOITE A CLAPETS	Includes: M083	37,50 €
	VME081	CAJA DE LAMINAS (CIRCUITO DE PULSO INTERNO) REED VALVE COMPLETE (INTERNAL PULSE CIRCUIT) BOITE A CLAPETS (CIRCUIT D'IMPULSION INTERNE)	Includes: M083 - ME083A	37,50 €
	VM082	LAMINAS (SET DE 2) REED VALVE PETALS (SET OF 2) LAMELLES (SET DE 2)		20,00 €
	VM083	JUNTA CAJA DE LAMINA (SET DE 2) REED VALVE GASKET (SET OF 2) JOINT BOITE A CLAPETS (SET DE 2)		3,75 €
	VME083	LAMINAS (CIRCUITO DE PULSO INTERNO - LADO CARTER) REED VALVE GASKET (INTERNAL PULSE CIRCUIT - CARTER SIDE) LAMELLES (CIRCUIT D'IMPULSION INTERNE - CÔTÉ CARTER)		1,88 €
	VME083a	LAMINAS (CIRCUITO DE PULSO INTERNO - LADO CARBURADOR) REED VALVE GASKET (INTERNAL PULSE CIRCUIT - CARBURETOR SIDE) LAMELLES (CIRCUIT D'IMPULSION INTERNE - CÔTÉ CARBURATEUR)		1,88 €

	VM084	PLACA SUJECCIÓN CARBURADOR, NARANJA CARBURETOR FLANGE, ORANGE PLAQUE CARBURATEUR, ORANGE	25,00 €
	VME084	PLACA SUJECCIÓN CARBURADOR, NARANJA (CIRCUITO DE PULSO INTERNO) CARBURETOR FLANGE, ORANGE (INTERNAL PULSE CIRCUIT) PLAQUE CARBURATEUR, ORANGE (CIRCUIT D'IMPULSION INTERNE)	25,00 €
	VM085	TORNILLO 6 X 20 MM TCEI DIN912 (SET OF 2) BOLT 6 X 20 MM TCEI DIN912 (SET OF 2) VIS 6 X 20 MM TCEI DIN912 (SET OF 2)	0,63 €
	VM085a	TORNILLO 6 X 25 MM TCEI DIN912 (SET OF 4) BOLT 6 X 25 MM TCEI DIN912 (SET OF 4) VIS 6 X 25 MM TCEI DIN912 (SET OF 4)	1,25 €
	VM086	SOPORTE CABLE DE GAS INOX BRACKET FOR THROTTLE CABLE SUPPORT CABLE DE GAS	3,75 €
	VME086a	PASO DOBLADO EN LATÓN PARA EL SOPORTE DE GAS BENDING PASSAGE IN BRASS FOR THROTTLE CABLE PASSAGE PLIAGE EN LAITON POUR CÂBLE D'ACCÉLÉRATEUR	12,50 €
	VM087	REGULADOR DE ACELERADOR Ø 6 MM THROTTLE ADJUSTER Ø 6 MM RÉGULATEUR DU ACCELERATEUR Ø 6MM	1,88 €
	VM088	JUNTA CARBURADOR (SET DE 2) CARBURETOR GASKET (SET OF 2) JOINT CARBURATEUR (SET DE 2)	3,75 €
	VME088	JUNTA CARBURADOR (INT. PULSE CIRCUIT) (SET DE 2) CARBURETOR GASKET (INT. PULSE CIRCUIT) (SET OF 2) JOINT CARBURATEUR (INT. PULSE CIRCUIT) (SET DE 2)	3,75 €
	VM089	JUNTA DE BAQUELITA BAKELITE GASKET JOINT EN BAKÉLITE	10,00 €
	VME089	JUNTA DE BAQUELITA (INT. PULSE CIRCUIT) BAKELITE GASKET (INT. PULSE CIRCUIT) JOINT EN BAKÉLITE (INT. PULSE CIRCUIT)	10,00 €
	VM090	CARBURADOR WALBRO 37 MOSTER WALBRO 37 MOSTER CARBURETTOR CARBURATEUR WALBRO 37 MOSTER	162,50 €
	VMP090	CARBURADOR WALBRO MOSTER185 PLUS/FACTORY CARBURETOR WALBRO FOR MOSTER185 PLUS/FACTORY CARBURATEUR MOSTER185 PLUS/FACTORY	162,50 €
	VMPE090	CARBURADOR WALBRO MOSTER185 PLUS/FACTORY (INT. PULSE CIRCUIT) CARBURETOR WALBRO FOR MOSTER185 PLUS/FACTORY (INT. PULSE CIRCUIT) CARBURATEUR MOSTER185 PLUS/FACTORY (INT. PULSE CIRCUIT)	162,50 €
	VM091	CONECTOR DE PLÁSTICO AIR-BOX PLASTIC AIR-BOX CONNECTOR CONNECTEUR DE BOÎTE À AIR EN PLASTIQUE	Includes: M091A 17,50 €
	VM091a	JUNTA TÓRICA Ø 33,05 X 1,78 MM O-RING VITON Ø 33,05 X 1,78 MM JOINT TORIQUE Ø 33,05 X 1,78 MM	1,88 €
	VM092	TORNILLO 6 X 60 MM TCEI DIN912 (SET OF 2) BOLT 6 X 60 MM TCEI DIN912 (SET OF 2) VIS 6 X 60 MM TCEI DIN912 (SET OF 2)	1,25 €
	VM093	AIR-BOX SILENCER COMPLETE AIRBOX COMPLETO AIRBOX COMPLET	Includes: M093A - M093B - M093C - M094 56,25 €
	VMP093	AIR-BOX SILENCER COMPLETE MY19 AIRBOX COMPLETO MY19 AIRBOX COMPLET MY19	Includes: AT093A - MP093D - M094 70,00 €
	AT093a	GOMA DE UNION AIRBOX CON ESPONJA INCORPORADA AIR-BOX RUBBER MANIFOLD WITH INCORPORATED SPONGE GOMME UNION AIRBOX AVEC ÉPONGE INTÉGRÉE	28,75 €
	VM093a	AIR-BOX RUBBER MANIFOLD GOMA DE UNION AIRBOX GOMME UNION AIRBOX	18,75 €





	VM093b	ESPONJA SILENCIADOR (AIRBOX) AIRBOX SPONGE ÉPONGE AIRBOX	12,50 €
	VMP093b	SNAPLOCK MALE E FEMALE Ø 16 MM, GREY SNAPLOCK MALE E FEMALE Ø 16 MM, GREY SNAPLOCK MALE E FEMALE Ø 16 MM, GREY	8,75 €
	VM093c	ENGANCHE AIRBOX KIT FIXING PLATE (AIRBOX) ACCROCHAGE AIRBOX	3,75 €
	VMP093c	SNAPLOCK FEMALE Ø 18 MM, BLACK SNAPLOCK FEMALE Ø 18 MM, BLACK SNAPLOCK FEMALE Ø 18 MM, BLACK	3,75 €
	VMP093d	SNAPLOCK FEMALE Ø 16 MM, GREY SNAPLOCK FEMALE Ø 16 MM, GREY SNAPLOCK FEMALE Ø 16 MM, GREY	3,75 €
	VMP093k	AIRBOX COMPLETO MY19 (KIT DE ACTUALIZACIÓN) AIR-BOX SILENCER COMPLETE MY19 (COMPLETE UPGRADE KIT) AIRBOX COMPLET MY19 (KIT DE MISE À JOUR)	Includes: AT093A- MP093B-MP093D- TOOL-MP093E-M094 73,75 €
	VMP093e	FUEL JUNCTION, L-SHAPED FUEL JUNCTION, L-SHAPED FUEL JUNCTION, L-SHAPED	6,25 €
	VM094	ABRAZADERA AIRBOX 50-70MM FIXING BAND 50-70 MM COLLIER AIRBOX 50-70MM	2,50 €
	VM095	TUBO CARBURADOR 155mm PIPE PRESSURE 155 mm TUBE CARBURATEUR 155mm	2,50 €
	VM095a	TUBO CARBURADOR 115mm PIPE PRESSURE 115 mm TUBE CARBURATEUR 115mm	2,50 €
	VM096	ABRAZADERA METAL Ø 10,5 mm FIXING CLAMP Ø 10,5 mm COLLIER METALIQUE Ø 10,5 mm	1,25 €
	VM096a	ABRAZADERA DOBLE MUELLE 10,4/11MM DOUBLE WIRE SPRING HOSE CLUMP 10,4/11 MM COLLIER 10,4/11MM	1,25 €
	VMP102	EMBRAGUE COMPLETO COMPLETE CLUTCH EMBAYAGE COMPLET	96,25 €
	VMP103	MUELLE DE EMBRAGUE CLUTCH SPRING RESSORT D'EMBAYAGE	8,75 €
	VMP104	CAMPANA/POLEA PEQUEÑA Ø 44,0 MM CON RODAMIENTOS, NEGRO DRUM/PINION Ø 44,0 MM ASSEMBLED WITH BEARINGS, BLACK CLOCHE D'EMBAYAGE / POULIE PETITE Ø 44,0 MM AVEC ROULEMENTS, NOIR ----- includes: MP105 - MP106 - MP107 - MP107a	97,50 €
	VMP104a	CAMPANA/POLEA PEQUEÑA Ø 46,5 MM CON RODAMIENTOS, NEGRO DRUM/PINION Ø 46,5 MM ASSEMBLED WITH BEARINGS, BLACK CLOCHE D'EMBAYAGE / POULIE PETITE Ø 46,5 MM AVEC ROULEMENTS, NOIR ----- includes: MP105 - MP106 - MP107 - MP107a	97,50 €
	VMP105	ANILLO SEEGER Ø 35 MM DIN 472 (SET DE 2) SEEGER Ø 35 MM DIN 472 (SET OF 2) ANNEAUX SEEGER Ø 35 MM DIN 472 (SET OF 2)	1,25 €
	VM105a	POLEA PEQUEÑA ø44 mms (44 / 130 mms.) LITTLE PULLEY ø44 mms (44 / 130 mms.) POULIE PETITE ø44 mms (44 / 130 mms.)	22,50 €
	VM105c	POLEA PEQUEÑA ø46,5 mms (46,5 / 128 mms.) LITTLE PULLEY ø46,5 mms (46,5 / 128 mms.) POULIE PETITE ø46,5 mms (46,5 / 128 mms.)	22,50 €
	VM106	ARANDELA (PIÑÓN) ø 10 est. 21 mms. WASHER (PINION) ø 10 est. 21 mms. RONDELLE (PIGNON) ø 10 est. 21 mms.	0,32 €

	VMP106	RODAMIENTO 35/15/11 MM - 2Z AND RODAMIENTO 35/15/11 MM - 2HRS BEARING 35/15/11 MM - 2Z AND BEARING 35/15/11 MM - 2HRS ROULEMENT 35/15/11 MM - 2Z AND ROULEMENT 35/15/11 MM - 2HRS	12,00 €
	VM107	TUERCA (PIÑÓN) 10 x 1.25 mms. NUT (PINION) 10 x 1.25 mms. ÉCROU (PIGNON) 10 x 1.25 mms.	1,25 €
	VMP107	ANILLO SEEGER Ø 15 MM DIN 471. SEEGER Ø 15 MM DIN 471. ANNEAUX SEEGER Ø 15 MM DIN 471	0,63 €
	VMP107a	TAPA CAMPANA DRUM / PINION CUP COUVERCLE COCHE	3,75 €
	VM108	EXCENTRICO MONTADO CON RODAMIENTOS ECCENTRIC ASSEMBLED WITH BEARINGS EXCENTRIQUE MONTÉ AVEC DES ROULEMENTS ----- includes: M108a - M109 - M110 - M111 - M114 - M115 - M116	65,00 €
	VM108a	ARANDELA 22 X 32 MM 0,3/0,5 MM DIN 988PS (SET DE 2) SHIM WASHER 22 X 32 MM 0,3/0,5 MM DIN 988PS (SET OF 2) RONDELLE 22 X 32 MM 0,3/0,5 MM DIN 988PS (SET DE 2)	2,50 €
	VM109	ANILLO SEEGER Ø 20 MM DIN 471 SEEGER Ø 20 MM DIN 471 ANNEAUX SEEGER Ø 20 MM DIN 471	0,88 €
	VM110	ARANDELA Ø 8 EXT. 24 X 5 MM, NARANJA WASHER Ø 8 EXT. 24 X 5 MM, ORANGE RONDELLE Ø 8 EXT. 24 X 5 MM, ORANGE	3,13 €
	VM111	TORNILLO 8 X 16 MM TE DIN933 BOLT 8 X 16 MM TE DIN933 VIS 8 X 16 MM TE DIN933	0,63 €
	VM111a	PASO IZQUIERDO 8 X 16 MM TE, NEGRO BOLT 8 X 16 MM TE LEFT THREADED, BLACK PAS GAUCHE 8 X 16 MM TE, NOIR	0,63 €
	VM112	TORNILLO 6 X 25 MM TCEI DIN912 (SET DE 2) BOLT 6 X 25 MM TCEI DIN912 (SET OF 2) VIS 6 X 25 MM TCEI DIN912 (SET DE 2)	1,25 €
	VM112a	TORNILLO 6 X 35 MM TCEI DIN 912 (ROSCADO) BOLT 6 X 35 MM TCEI DIN 912 (ALL THREADED) VIS 6 X 35 MM TCEI DIN 912 (FILETÉ)	0,63 €
	VM113	POLEA GRANDE ø128 mms. (128 / 46,5 mms) BIG PULLEY ø128 mms. (128 / 46,5 mms) POULIE GRANDE ø128 mms. (128 / 46,5 mms)	75,00 €
	VM113a	POLEA GRANDE ø130 mms. (130 / 44 mms) BIG PULLEY ø130 mms. (130 / 44 mms) POULIE GRANDE ø130 mms. (130 / 44 mms)	75,00 €
	VM113b	POLEA GRANDE COMPLETA Ø128 MMS. COMPLETE BIG PULLEY Ø128 MMS. POULIE GRANDE COMPLET Ø128 MMS. ----- includes: VM108+VM115+2X VM114+VM116+VM109+VM113b	125,00 €
	VM113c	POLEA GRANDE COMPLETA ø130 mms. COMPLETE BIG PULLEY ø130 mms. POULIE GRANDE COMPLET ø130 mms. ----- includes: VM108+VM115+2X VM114+VM116+VM109+VM113	125,00 €
	VMP113	POLEA Ø 128 MM 13 RANURAS, NEGRO PULLEY Ø 128 MM 13 GROOVES, BLACK POULIE Ø 128MM 13 FENTES, NOIR	75,00 €
	VMP113a	POLEA Ø 130 MM 13 RANURAS, NEGRO PULLEY Ø 130 MM 13 GROOVES, BLACK POULIE Ø 130 MM 13 FENTES, NOIR	75,00 €

	VMP113b	POLEA Ø 128 MM 13 RANURAS MONTADO CON EXCÉNTRICO, NEGRO PULLEY Ø 128 MM 13 GROOVES ASSEMBLED WITH ECCENTRIC, BLACK POULIE Ø 128 MM 13 FENTES ASSEMBLÉ AVEC EXCENTRIQUE, NOIR	130,00 €
		includes: M108	
	VMP113c	POLEA Ø 130 MM 13 RANURAS MONTADO CON EXCÉNTRICO, NEGRO PULLEY Ø 130 MM 13 GROOVES ASSEMBLED WITH ECCENTRIC, BLACK POULIE Ø 130 MM 13 FENTES ASSEMBLÉ AVEC EXCENTRIQUE, NOIR	130,00 €
		includes: M108	
	VM114	RODAMIENTO 42/20/12 MM (SET DE 2) BEARING 42/20/12 MM (SET OF 2) ROULEMENT 42/20/12 MM (SET DE 2)	20,00 €
	VM115	ANILLO SEEGER Ø 42 MM DIN 472 SEEGER Ø 42 MM DIN 472 ANNEAUX SEEGER Ø 42 MM DIN 472	1,13 €
	VM116	SEPARADOR DE RODAMIENTO EN ACERO STEEL BEARING SPACER ENTRETOISE DE ROULEMENT EN ACIER	3,75 €
	VM117	CORREA POLY-V PJ483 POLY-V PJ483 BELT COURROIE POLY-V PJ483	40,00 €
	VMP117	CORREA POLY V PJ483 13 RANURAS BELT POLY V PJ483 13 GROOVES COURROIE POLY V PJ483 13 FENTES	40,00 €
	VM118	CONTRAPLACA HELICE, NARANJA FLANGE PROPELLER, ORANGE CONTRAPLAQUE D'HELICE, ORANGE	8,75 €
	(VM119) H6650	KIT TORNILLOS HELICE M6 X 50mm. 6 Unidades KIT SCREW M6 X 50 mm. PROPELLER. 6 Unities KIT VIS HELICE M6 X 50 mm. 6 Unitées	3,75 €
	(VM119) H6660	KIT TORNILLOS HELICE M6 X 60mm. 6 Unidades KIT SCREW M6 X 60 mm. PROPELLER. 6 Unities KIT VIS HELICE M6 X 60 mm. 6 Unitées	3,75 €
	VM120	SEPARADOR DE HELICE ALUMINIO, NARANJA ALUMINUM SPACER FOR PROPELLER WITH EXTRA COOLING, ORANGE SÉPARATEUR D'HELICE EN ALUMINIUM, ORANGE	16,25 €
	VM135	ESCAPE SIN SILENCIADOR, INCLUYE SOPORTE VME150 EXHAUST WITHOUT SILENCER, INCLUDING SUPPORT VME150 ÉCHAPPEMENT SANS SILENCIEUX, AVEC SUPPORT VME150	312,50 €
	VM135a	ROTULA ESCAPE MANIFOLD EXHAUST JOINT D'ÉCHAPPEMENT MÉTALLIQUE	22,50 €
	VMP135	ESCAPE COMPLETO NEGRO, SIN SILENCIADOR COMPLETE MUFFLER BLACK, WITHOUT SILENCER ÉCHAPPEMENT COMPLÈTE NOIR, SANS SILENCIEUX	343,75 €
		includes: M137 - M019 - M138a - MP142 - 151a - 151c - MP155 - M141	
	VMP135	ESCAPE COMPLETO NEGRO, SIN SILENCIADOR COMPLETE MUFFLER BLACK, WITHOUT SILENCER ÉCHAPPEMENT COMPLÈTE NOIR, SANS SILENCIEUX	343,75 €
		includes: M137 - M019 - M138a - MP142 - 151a - 151c - MP155 - M141	
	VMY135	ÉCHAPPEMENT COMPLÈTE NOIR MY19 (4 RESSORTS), SANS SILENCIEUX COMPLETE MUFFLER BLACK MY19 (4 SPRINGS), WITHOUT SILENCER ESCAPE COMPLETO NEGRO M19 (4 MUELLES), SIN SILENCIADOR	343,75 €
		includes: M137 - M019 - M138a - MY142 - 151a - 151c - MP155 - ME150 - M018a - M141	

	VM136	EXHAUST STUD Ø 8 X 38 MM (SET OF 2) EXHAUST STUD Ø 8 X 38 MM (SET OF 2) GOUJONS D'ÉCHAPPEMENT Ø 8 X 38 MM (SET DE 2)	6,25 €
	VM137	JUNTA ESCAPE EXHAUST GASKET JOINT D'ÉCHAPPEMENT	3,75 €
	VM138a	ARANDELAS Ø 8 MM DIN 127B (SET DE 2) WASHER GROWER Ø 8 MM DIN 127B (SET OF 2) RONDELLES Ø 8 MM DIN 127B (SET DE 2)	0,63 €
	VM139	MUELLES DE ESCAPE (SET DE 4) EXHAUST SPRING (SET OF 4) RESSORTS D'ÉCHAPPEMENT (SET DE 4)	10,00 €
	VMP139	MUELLES ESCAPE. 3 Unidades EXHAUST SPRING. 3 Unities RESSORT ECHAPPEMENT. 3 Unitées	7,50 €
	VM139a	CABLE DE SEGURIDAD 45CM CON REMACHES DE ALUMINIO SECURITY CABLE 45 CM WITH ALUMINUM CLAMP CÂBLE DE SÉCURITÉ 45CM AVEC RIVETS EN ALUMINIUM	1,25 €
	VM140	ABRAZADERA SILENCIOSO SILENCER STEEL BRACKET COLLIER POUR SILENCIEUX	15,00 €
	VMP140	TUBO TERMORETRACTIL (SET DE 4) HEAT SHRINKABLE TUBING (SET OF 4) TUBE THERMORÉTRACTABLE (SET DE 4)	2,50 €
	VM141	SEPARADOR DE GOMA RUBBER SPACER SEPARATEUR EN CAOUTCHOUC	1,87 €
	VMP141	CABLE DE SEGURIDAD 37CM CON REMACHES DE ALUMINIO (SET DE 3) SECURITY CABLES 37 CM WITH ALUMINUM CLAMPS (SET OF 3) CÂBLE DE SÉCURITÉ 37CM AVEC RIVETS EN ALUMINIUM (SET DE 3)	3,75 €
	VME141	CABLE DE SEGURIDAD MUELLES ESCAPE SECURITY CABLE WITH CLAMP FOR EXHAUST SPRINGS CÂBLE DE SÉCURITÉ DU RESSORT ECHAPPEMENT.	1,25 €
	VM142	TORNILLO 8 X 25 MM TCEI DIN 912 BOLT 8 X 25 MM TCEI DIN 912 VIS 8 X 25 MM TCEI DIN 912	0,62 €
	VMP142	ROTULA DE ESCAPE (3 MUELLES) CON JUNTA DE COBRE 20/25 HORAS Y MUELLES EXHAUST FLANGE (3 SPRINGS) WITH ASSEMBLED BUSHING 20/25 HOURS AND SPRINGS JOINT D'ÉCHAPPEMENT MÉTALLIQUE (3 RESSORTS) AVEC JOINT DE BRONZE 20/25 HUERES ET RESSORTS includes: M019 - M138a	37,50 €
	VME142	ROTULA DE ESCAPE (3 MUELLES) CON JUNTA DE COBRE 40/50 HORAS Y MUELLES EXHAUST FLANGE (3 SPRINGS) WITH ASSEMBLED BUSHING 40/50 HOURS AND SPRINGS JOINT D'ÉCHAPPEMENT MÉTALLIQUE (3 RESSORTS) AVEC JOINT DE BRONZE 40/50 HUERES ET RESSORTS includes: M019 - M138a	37,50 €
	VMY142	ROTULA DE ESCAPE MY19 (4 MUELLES) CON JUNTA DE COBRE 40/50 HORAS Y MUELLES EXHAUST FLANGE MY19 (4 SPRINGS) WITH ASSEMBLED BUSHING 40/50 HOURS AND SPRINGS JOINT D'ÉCHAPPEMENT MÉTALLIQUE MY19 (4 RESSORTS) AVEC JOINT DE BRONZE 40/50 HUERES ET RESSORTS includes: M019 - M138a	40,00 €
	VM143	ARANDELA Ø 8 EST. 24 MM DIN 9021 (SET DE 2) WASHER Ø 8 EST. 24 MM DIN 9021 (SET OF 2) RONDELLE Ø 8 EST. 24 MM DIN 9021 (SET DE 2)	0,62 €
	VMP143	KIT JUNTA DE COBRE 20/25 HORAS CON MUELLES Y CABLE DE SEGURIDAD KIT BRONZE BUSHING 20/25 HOURS WITH SPRINGS AND SAFETY CABLES KIT JOINT DE BRONZE 20/25 HEURES AVEC RESSORTS ET CABLE DE SÉCURITÉ includes: MP143a - M139 - MP140 -MP141	18,75 €
	VME143	KIT JUNTA DE COBRE 40/50 HORAS CON MUELLES Y CABLE DE SEGURIDAD KIT BRONZE BUSHING 40/50 HOURS WITH SPRINGS AND SAFETY CABLES KIT JOINT DE BRONZE 40/50 HEURES AVEC RESSORTS ET CABLE DE SÉCURITÉ includes: MP143a - M139 - MP140 -MP141 - M139a	22,50 €

	VME143a	JUNTA DE COBRE 40/50 HORAS BRONZE BUSHING 40/50 HOURS JOINT DE BRONZE 40/50 HEURES	12,50 €
	VMP143a	JUNTA DE COBRE 20/25 HORAS BRONZE BUSHING 20/25 HOURS JOINT DE BRONZE 20/25 HEURES	10,00 €
	VM144	TUBO DE CARBONO EXTERIOR DEL SILENCIADOR DEL ESCAPE EXTERNAL CARBON SILENCER PIPE 135 MMS TUBE CARBONE EXTERIEUR SILENCIEUX 135 MM	43,75 €
	VM144a	TIRAS METALICAS SILENCIADOR SET OF 2 TIES FOR SILENCER CRAVATES POUR SILENCIEUX	5,00 €
	VM145	TAPA Y FIBRA INTERNA DEL SILENCIADOR DEL ESCAPE INTERNAL STRUCTURE SILENCER AND CAP FIBRE SILENCIEUX AND BOUCHON	38,75 €
	VM146	BOQUILLA SILENCIADOR SILENCER CAP BOUCHON SILENCIEUX	22,50 €
	VM147	FIBRA SILENCIADOR SILENCER FIBER (NOISE ABSORBENT MATERIAL) FIBRE SILENCIEUX	16,25 €
	VM148	REMACHE DE ALUMINIO Ø 4 MMS. NEGRO. 10 UNIDADES ALUMINIUM RIVET Ø 4 MMS. BLACK. 10 UNITIES ROVETS ALUMINIUM Ø 4 MMS. NOIR. 10 UNITÉES	3,90 €
	VM149	JUNTA SILENCIADOR SILENCER GASKET JOINT SILENCIEUX	3,75 €
	VM150	TUERCA AUTOBLOCANTE 6MA DIN 980 (SET DE 3) Y TUERCA 6MA DIN 934 (SET DE 3) LOCK NUT 6MA DIN 980 (SET OF 3) AND NUT 6MA DIN 934 (SET OF 3) ÉCROU AUTOBLOQUANT 6MA DIN 980 (SET DE 3) Y ÉCROU 6MA DIN 934 (SET DE 3)	1,88 €
	VMP150	PLACA SOPORTE ESCAPE EXHAUST SUPPORT PLATE PLAQUE DE SUPPORT D'ÉCHAPPEMENT	30,00 €
	VME150	PLACA SOPORTE ESCAPE EXHAUST SUPPORT PLATE PLAQUE DE SUPPORT D'ÉCHAPPEMENT	30,00 €
	VM150a	TUERCA M6 (SILENCIADOR). 1 UD NUT M6 (SILENCER). 1 UT ÉCROU M6 (SILENCIEUX). 1 UT	0,32 €
	VMP150a	PLACA SOPORTE ESCAPE EXHAUST SUPPORT PLATE PLAQUE DE SUPPORT D'ÉCHAPPEMENT	30,00 €
	VM151a	SILENTBLOCK 30 X 20 MM MOU (IZQUIERDO) 14/20 MM ANTIVIBRATION MOUNT 30 X 20 MM SOFT (LEFT) 14/20 MM SILENTBLOCK 30 X 20 MM MOU (GAUCHE) 14/20 MM	5,63 €
		INCLUDES: M018 - M019)	
	VM151b	SILENTBLOCK 30 X 20 DURO (DERECHO) 14/20 MM SILENTBLOCK 30 X 20 HARD (RIGHT) 14/20 MM SILENTBLOCK 30 X 20 DUR (DROITE) 14/20 MM	4,37 €
	VM151c	SILENTBLOCK 30 X 20 MM DURO (DERECHO) 14/14 MM ANTIVIBRATION MOUNT 30 X 20 MM HARD (RIGHT) 14/14 MM (SET OF 2) SILENTBLOCK 30 X 20 MM DUR (DROITE) 14/20 MM	11,25 €
		INCLUDES: M018 - M019)	
	VMP155	JUNTA DEL SILENCIADOR SILENCER GASKET JOINT SILENCIEUX	3,75 €
	VMP157	ESTRUCTURA INTERNA SILENCIADOR 350MM INTERNAL SILENCER STRUCTURE 350 MM STRUCTURE DE SILENCIEUX INTERNE 350MM	56,25 €
	VMP158	TAPA DE SILENCIADOR SILENCER CAP COUVERCLE DE SILENCIEUX	37,50 €







	VMP159	FIBRE DE SILENCIEUX NOISE ABSORBENT MATERIAL FIBRA DEL SILENCIADOR	INCLUDES: MP161	16,25 €
	VMP160a	TUBO DE SILENCIADOR EN CARBONO 350 CARBON FIBER PIPE SILENCER 350 MM TUBE SILENCIEUX EN CARBONE 350MM		56,25 €
	VMP161	REMACHES INOX Ø 5 MM (SET DE 10) INOX RIVET Ø 5 MM (SET OF 10) RIVETS INOX Ø 5 MM (SET DE 10)		6,25 €
	VMP162	ABRAZADERA DEL SILENCIADOR PARA TUBO DE CARBONO SILENCER STEEL BRACKET FOR CARBON PIPE COLLIER POUR SILENCIEUX POUR TUBE DE CARBONE	INCLUDES: MP141	18,75 €
	VMP162a	ABRAZADERA DEL SILENCIADOR PARA TUBO DE ALUMINIO SILENCER STEEL BRACKET FOR ALUMINUM PIPE COLLIER POUR SILENCIEUX POUR TUBE EN ALUMINIUM	INCLUDES: MP141	18,75 €
	VMP164	TORNILLO 8 X 20 MM TCEI DIN 912 BOLT 8 X 20 MM TCEI DIN 912 VIS 8 X 20 MM TCEI DIN 912		0,62 €
	VMP166	ESCAPE COMPLETO NEGRO, MONTADO CON SILENCIADOR Y PLACA COMPLETE MUFFLER BLACK, ASSEMBLED WITH SILENCER AND PLATE ÉCHAPPEMENT NOIR COMPLÈTE, MONTÉ AVEC SILENCIEUX ET PLAQUE ----- INCLUDES: MP135 - MP167 - MP162 - MP150		481,25 €
	VME166	ESCAPE COMPLETO NEGRO, MONTADO CON SILENCIADOR Y PLACA COMPLETE MUFFLER BLACK, ASSEMBLED WITH SILENCER AND PLATE ÉCHAPPEMENT NOIR COMPLÈTE, MONTÉ AVEC SILENCIEUX ET PLAQUE ----- INCLUDES: ME135 - MP167 - MP162 - ME150		481,25 €
	VMY166	ESCAPE COMPLETO NEGROMY19 (4 MUELLES), MONTADO CON SILENCIADOR Y PLACA COMPLETE MUFFLER BLACK MY19 (4 SPRINGS), ASSEMBLED WITH SILENCER AND PLATE ----- INCLUDES: MY135 - MP167 - MP162 - ME150		481,25 €
	VMP167	SILENCIADOR COMPLETO 350MM MONTADO COMPLETE SILENCER 350 MM ASSEMBLED SILENCIEUX COMPLET 350 MM MONTÉ ----- INCLUDES: MP155 - M150		125,00 €
	VM180	PIPE RETAINING CLIP 08/12 MM, BOLT 4 X 20 MM TSEI AND NUT WITH FLANGE M4		2,50 €
	VM181	ABRAZADERA PRESIÓN SUJECCIÓN BOBINA PIPE RETAINING CLIP 08/12 MM COLLIER POUR BOBINE		1,25 €
	VM182	TUERCA M4 NUT M4 ÉCROU M4		0,32 €
	VM200	ARANDELA Ø 6 X 12 MM DIN125A (SET DE 2) WASHER Ø 6 X 12 MM DIN125A (SET OF 2) RONDELLE Ø 6 X 12 MM DIN125A (SET DE 2)		0,63 €
	VMY200	ESCAPE COMPLETO NEGRO MY20, CON SILENCIADOR, SIN PLACA COMPLETE MUFFLER BLACK MY20, WITH SILENCER, WITHOUT PLATE ÉCHAPPEMENT NOIR COMPLÈTE MY20, AVEC SILENCIEUX, SANS PLAQUE ----- INCLUDES: MY201 - MY151a - MY151c - MP155 - M141		412,50 €
	VMY200a	ESCAPE NEGRO MY20, PARTE INICIAL EXHAUST BLACK MY20, INITIAL PART ÉCHAPPEMENT NOIR MY20, PARTIE INITIALE		150,00 €
	VMY200b	ESCAPE NEGRO MY20, PARTE FINAL EXHAUST BLACK MY20, FINAL PART ÉCHAPPEMENT NOIR MY20, PARTIE FINAL		212,50 €
	VMY200c	ESCAPE COMPLETO NEGRO MY20, MONTADO CON SILENCIADOR, PLACA Y SILENTBLOCKS COMPLETE MUFFLER BLACK MY19 (4 SPRINGS), ASSEMBLED WITH SILENCER, PLATE AND ANTI-VIB. MOUNTS ÉCHAPPEMENT NOIR COMPLÈTE MY19 (4 RESSORTS), MONTÉ AVEC SILENCIEUX, PLAQUE AND SILENTBLOCKS		543,75 €

MOSTER 185

PVP

VMY201	ROTULA DE ESCAPE MY19 (4 MUELLES) CON JUNTA DE COBRE 40/50 HORAS Y MUELLES EXHAUST FLANGE MY19 (4 SPRINGS) WITH ASSEMBLED BUSHING 40/50 HOURS AND SPRINGS JOINT D'ÉCHAPPEMENT MÉTALLIQUE MY19 (4 RESSORTS) AVEC JOINT DE BRONZE 40/50 HEURES ET RESSORTS INCLUDES: M127 – M019 – M138A	48,75 €
VMY202	KIT JUNTA DE COBRE 40/50 HORAS MY20 CON MUELLES Y CABLE DE SEGURIDAD KIT BRONZE BUSHING 40/50 HOURS MY20 WITH SPRINGS AND SAFETY CABLES KIT JOINT DE BRONZE 40/50 HEURES MY20 AVEC RESSORTS ET CABLE DE SÉCURITÉ	31,25 €
VMY202a	JUNTA DE COBRE 40/50 HORAS MY20 BRONZE BUSHING 40/50 HOURS MY20 JOINT DE BRONZE 40/50 HEURES MY20	21,25 €
VME300	SOPORTE PARA MOTOR DE ARRANQUE, NEGRO SUPPORT PLATE FOR ELECTRIC STARTER, BLACK SUPPORT DE DÉMARREUR, NOIR INCLUDES: MP060	20,00 €
VME301	MOTOR DE ARRANQUE, 14 DIENTES ELECTRIC STARTER, 14 TEETH DÉMARREUR ÉLECTRIQUE, 14 DENTS	223,75 €
VME303	BOBINA DE CARGA CHARGING COIL BOBINE DE CHARGE INCLUDES: M032 - M033	61,25 €
VME303a	REGULADOR DE VOLTAJE VOLTAGE REGULATOR RÉGULATEUR DE TENSION	48,75 €
VME304	TORNILLO 4 X 16 MM TSEI DIN7991 (SET OF 4) BOLT 4 X 16 MM TSEI DIN7991 (SET OF 4) VIS 4 X 16 MM TSEI DIN7991 (SET OF 4)	1,25 €
VME305	ENGRANAJE DE ARRANQUE STARTER GEAR ENGRENAGE DE DÉMARRAGE	48,75 €
VME307	TUERCA AUTOBLOCANTE ALTA TEMPERATURA M4 DIN 980, BLACK (SET DE 4) LOCK NUT HIGH TEMPERATURE M4 DIN 980, BLACK (SET OF 4) ECROU AUTOBLOQUANT HAUTE TEMPÉRATURE M4 DIN 980, BLACK (SET DE 4)	1,25 €
VME308	TORNILLO 6 X 6 MMS TBEI BOLT 6 X 6 MMS TBEI VIS 6 X 6 MMS TBEI	0,62 €
VME309	TORNILLO 6 X 6 MMS TBEI PLASTIC CAP (SET OF 3) VIS 6 X 6 MMS TBEI	1,88 €

FUERA DE LOS DESPIECES · OUT OF EXPLODED VIEWS · HORS VUES ÉCLATÉES

	ACC13	TAPA CILINDRO MOSTER CON KIT DE FIJACIÓN SUPERIOR MOSTER CYLINDER SHROUD WITH TOP FIXING KIT COUVERCLE CYLINDRE MOSTER AVEC FIXATION KIT SUPERIUR	156,25 €
	ACC13K	KIT DE FIJACIÓN SUPERIOR TAPA CILINDRO MOSTER TOP FIXING KIT FOR MOSTER CYLINDER SHROUD KIT FIXATION SUPERIUR DE COUVERCLE CYLINDRE MOSTER	7,80 €
	ACC15	TAPA CILINDRO MOSTER CON KIT DE FIJACIÓN LATERAL MOSTER CYLINDER SHROUD WITH LATERAL FIXING KIT COUVERCLE CYLINDRE MOSTER AVEC KIT FIXATION LATERAL	140,60 €
	ACC15K	KIT DE FIJACIÓN LATERAL TAPA CILINDRO MOSTER LATERAL FIXING KIT FOR MOSTER CYLINDER SHROUD KIT FIXATION LATERAL DE COUVERCLE CYLINDRE MOSTER	7,80 €
	VM021K	KIT SEPARADORES MOTOR Moster y Safari ALUMINIO 30 X 42 (INCLUYE TORNILLOS M8X55 + ARANDELAS) 4 Unidades ALUMINIUM Moster & Safari MOTOR SEPARATOR 30 X 42 KIT (SCREWS M8X55 + WASHERS INCLUDE) 4 Unities KIT ENTRETOISE moteur Moster et Safari ALUMINIUM NOIR 30 X 42 (INCLUS VIS M8X55 + RONDELLE) 4 Unitées	38,00 €
	VM025	JUEGO DE JUNTAS COMPLETO Y JUNTA CULATA COMPLETE SERIES OF GASKETS AND O-RING JEU DE JOINTS COMPLET ET JOINT CULASSE	25,00 €
	VMP052K	KIT DE POLEA FLASH STARTER (CLIQUETS Y MUELLES) KIT PULLEY EASY START (PLASTICS AND SPRINGS) KIT DE POLEA FLASH STARTER (CLIQUETS Y MUELLES)	Includes: MP044 - MP052 - MP054 111,25 €
	VM097	KIT REPARACION CARBURADOR WALBRO WB SERIES MEMBRANES AND GASKETS WALBRO WB KIT REPARATION CARBURATEUR WALBRO WB	18,75 €
	VM156	ESCAPE COMPLETO COMPLETE EXHAUST POT D'ÉCHAPPEMENT COMPLET	412,50 €
	VM157	SILENCIADOR DEL ESCAPE COMPLETO COMPLETE EXHAUST SILENCER SILENCIEUX ECHAPPEMENT COMPLET	112,50 €
	H_BOX	HANDY BOX MOSTER185 (SOLO PARA LAS VERSIONES MY19) HANDY BOX MOSTER185 (ONLY FOR VERSIONS MY19) HANDY BOX MOSTER185 (SEULEMENT POUR LES VERSIONS MY19)	144,00 €
		INCLUDES: M021A+M021B+M020+M031A+MP055+MP057+M043+ME143+M151A+M-151C+MP093B+ACC005+AC011+M097+M025+M018+M019+M138A+MP107A	
	BAT01	CAJA ARRANQUE ELÉCTRICO ELECTRIC STARTER BOX BOÎTE DÉMARREUR ÉLECTRIQUE	350,00 €

PAP

F200

BLOQUE MOTOR
MOTOR BLOCK
BLOQUE MOTEUR







PVP

	F020	COJINETE CIGÜEÑAL CRANKSHAFT BEARING ROULEMENT VILEBREQUIN	14,06 €
	F306	SEGMENTOS (2 Unidades) SEGMENTS (2 Unities) SEGMENTS (2 Unités)	24,12 €
	F406	JUNTA DE CULATA HEAD CYLINDER GASKET JOINT DE CULASSE	2,75 €

F200

REDUCTORA
REDUCTOR
RÉDUCTEUR





PVP

	F022	COJINETE DE REDUCTORA 6004 REDUCTION BEARING 6004 ROULEMENT REDUCTEUR 6004	9,50 €
	F023	COJINETE DE REDUCTORA 6204 REDUCTION BEARING 6204 ROULEMENT REDUCTEUR 6204	9,50 €
	F488	CLIP POLEA GRANDE PROPELLER BIG PULLEY RING SEGMENT POULIE GRANDE	3,00 €
	F290	CORREA PK POLY-V 560 K (NUEVO MODELO) PK POLY-V 560 K BELT (NEW TYPE) COURROIE PK POLY-V 560 K (NOUVEAU MODELLE)	42,97 €
	F290A	CORREA PJ 559 / 220 J ANTIGUA BELT PJ 559 / 220 (OLD TYPE) COURROIE PJ 559 / 220 (ANCIEN MODELLE)	42,97 €
	F100	EJE DE POLEA PINION STUD AXE DE POULIE	62,50 €
	F090	POLEA PEQUEÑA (REDUCTORA) NUEVO MODELO REDUCTION LITTLE PINION (NEW TYPE) PETIT PIGNON REDUCTEUR (NOUVEAU MODÈLE)	33,20 €
	F090A	POLEA PEQUEÑA (REDUCTORA) ANTIGUA REDUCTION LITTLE PINION (OLD TYPE) PETIT PIGNON REDUCTEUR (ANCIEN MODÈLE)	33,20 €
	F489	CLIP EJE POLEA PEQUEÑA PROPELLER SMALL PULLEY RING SEGMENT PETIE POULIE	3,00 €

F200

TUBO ESCAPE
EXHAUST PIPE
TUBE D'ÉCHAPPEMENT

PVP







	F284	MUELLE DE ESCAPE EXHAUST SPRING RESSORT D'ÉCHAPPEMENT	3,50 €
	F201	GOMA DEL SILENCIADOR RUBBER HOSING OF SILENCER GOMME UNION SILENCIEUX	8,59 €
	F182	SILENTBLOCK C30/20 (SILENCIADOR) SILENTBLOCK C30/20 (SILENCER) SILENTBLOCK C30/20 (SILENCIEUX)	4,50 €
	F500	ARANDELA TEFLON SILENTBLOCK TEFLON PAD OF SILENCER SILENTBLOCK JOINT TEFLON SILENTBLOCK SILENCIEUX	2,00 €

PAP

F200**ADMISION
ADMISSION
ADMISSION****PVP**

	F504	JUNTA CARBURADOR CARBURETTOR GASKET JOINT CARBURATEUR	1,95 €
	F311	GOMA DE UNION SILENCIADOR DE ADMISION (AIRBOX) AIRBOX RUBBER MANIFOLD GOMME UNION AIRBOX	16,60 €

F200**ENCENDIDO Y ARRANQUE
IGNITION & STARTER
ALLUMAGE ET DEMARREUR****PVP**

	F160	BOBINA COIL BOBINE	58,60 €
	F162	REGULADOR DE BATERIA Pb CHARGING COTROLLER Pb CHARGEUR DE BATTERIE Pb	33,20 €
	F155	VOLANTE ENCENDIDO SIN CORONA FLYWHEEL WITHOUT STARTER GEARING VOLANT MAGNETIQUE SANS COURONNE DE DÉMARREUR	244,14 €
	F154	CORONA - ANTIGUO MODELO - (DIAMETRO EXTERIOR 134 mm.) STARTER GEARING - OLD MODEL - (EXTERNAL DIAMETER 134 mm.) COURONNE DE DÉMARREUR - ANCIENE MODELE - (DIAMÈTRE EXTÉRIEUR 134 mm.)	48,82 €
	F150	ENCENDIDO STATOR STATOR	127,98 €
	W065	CONECTOR CARGADOR CONNECTOR CHARGER CONNECTEUR CHARGEUR	12,70 €
	W021	CONECTOR CAJA NEGRA NL4FX BLACK BOX NL4FX CONNECTOR CONNECTEUR NOIR BOÎTE NL4FX	12,70 €

POLINI THOR80

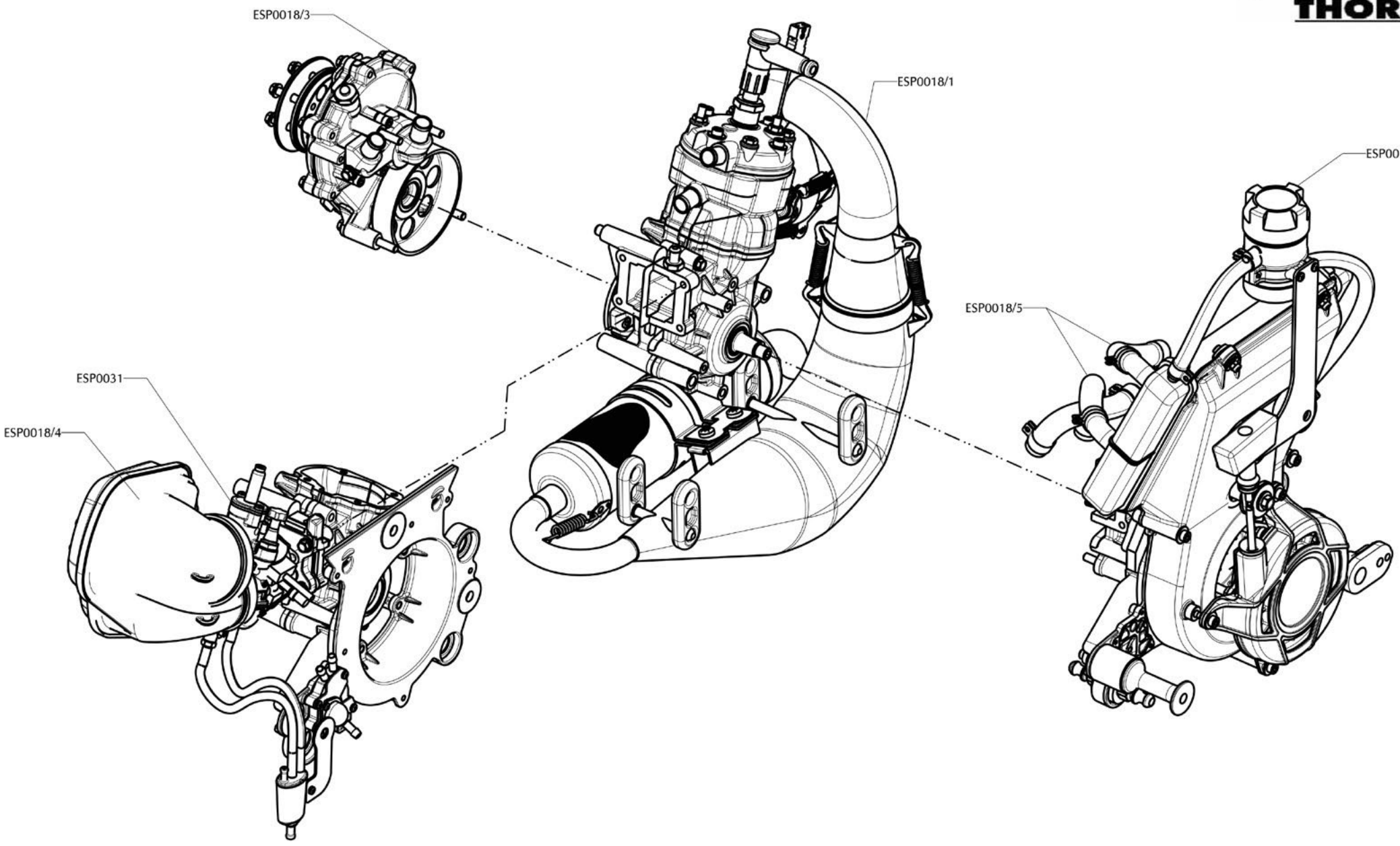

POLINI THOR80

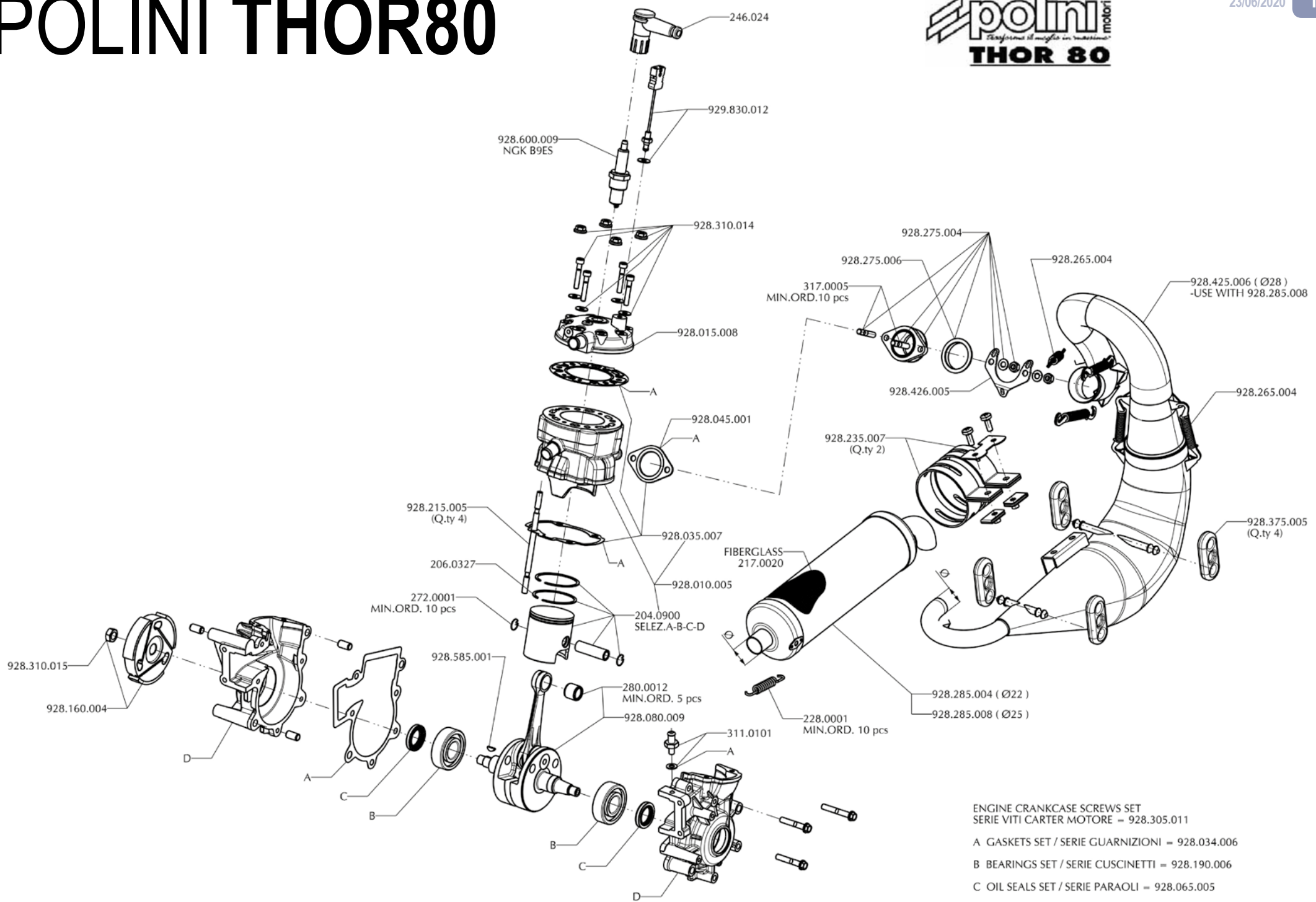

- ENGINE CRANKCASE SCREWS SET
SERIE VITI CARTER MOTORE = 928.305.011
- A GASKETS SET / SERIE GUARNIZIONI = 928.034.006
- B BEARINGS SET / SERIE CUSCINETTI = 928.190.006
- C OIL SEALS SET / SERIE PARAOLI = 928.065.005
- D CRANKCASE WITH OILSEALS & BEARINGS
CARTER CON PARAOLI E CUSCINETTI = 928.070.006

POLINI THOR80

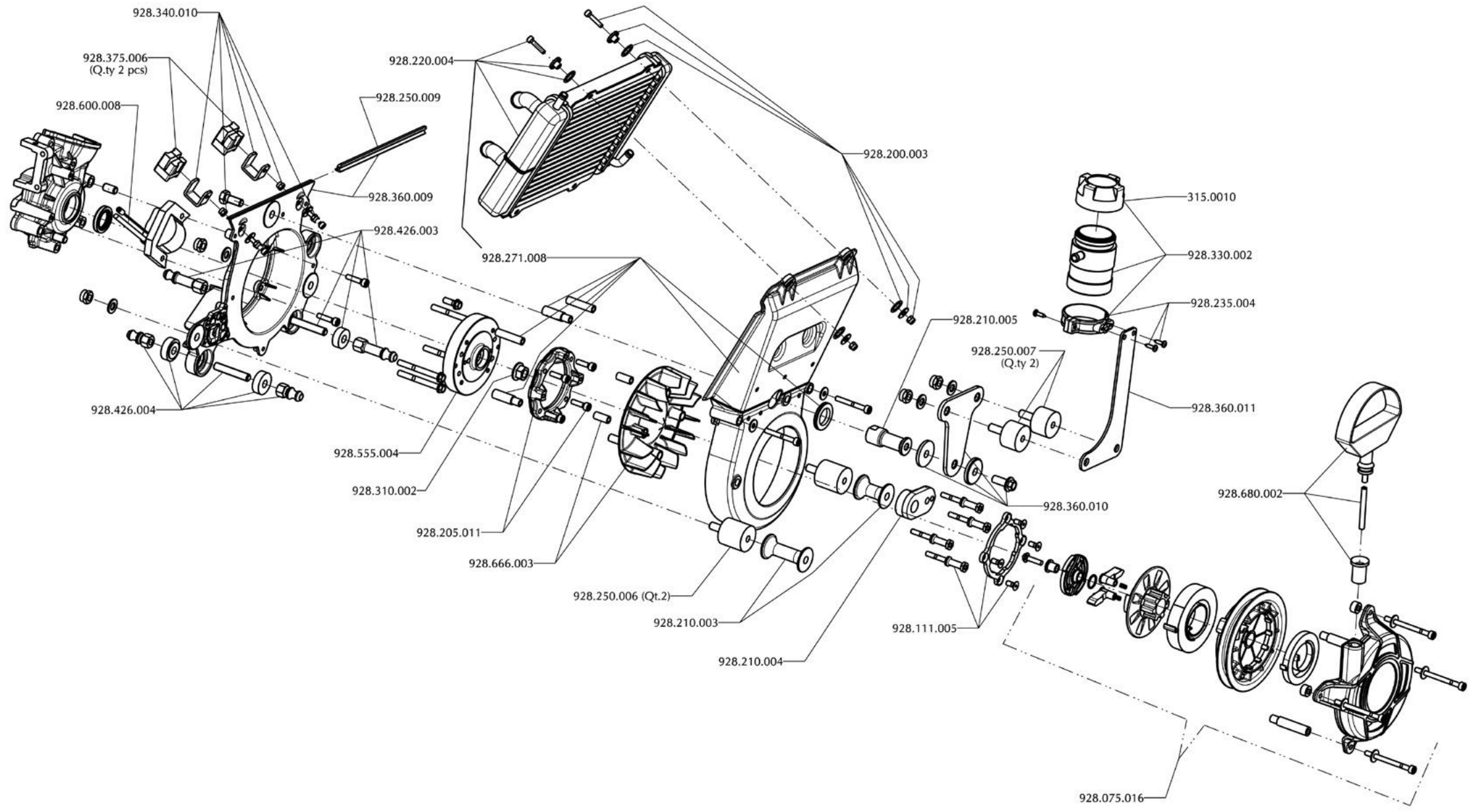

POLINI THOR80

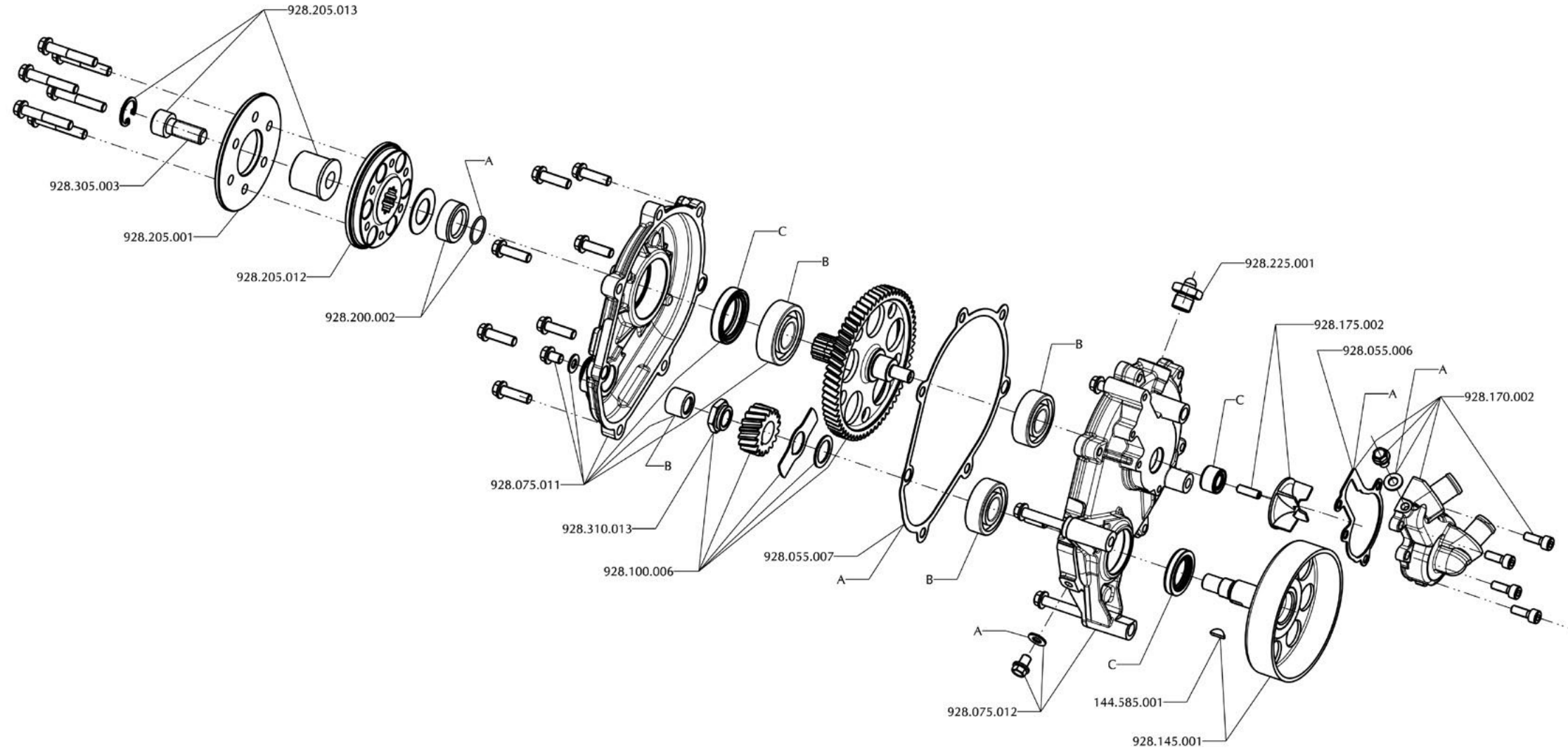

ENGINE CRANKCASE SCREWS SET
 SERIE VITI CARTER MOTORE = 928.305.011

A GASKETS SET / SERIE GUARNIZIONI = 928.034.006

B BEARINGS SET / SERIE CUSCINETTI = 928.190.006

C OIL SEALS SET / SERIE PARAOLII = 928.065.005

D CRANKCASE WITH OILSEALS & BEARINGS
 CARTER CON PARAOLI E CUSCINETTI = 928.070.006

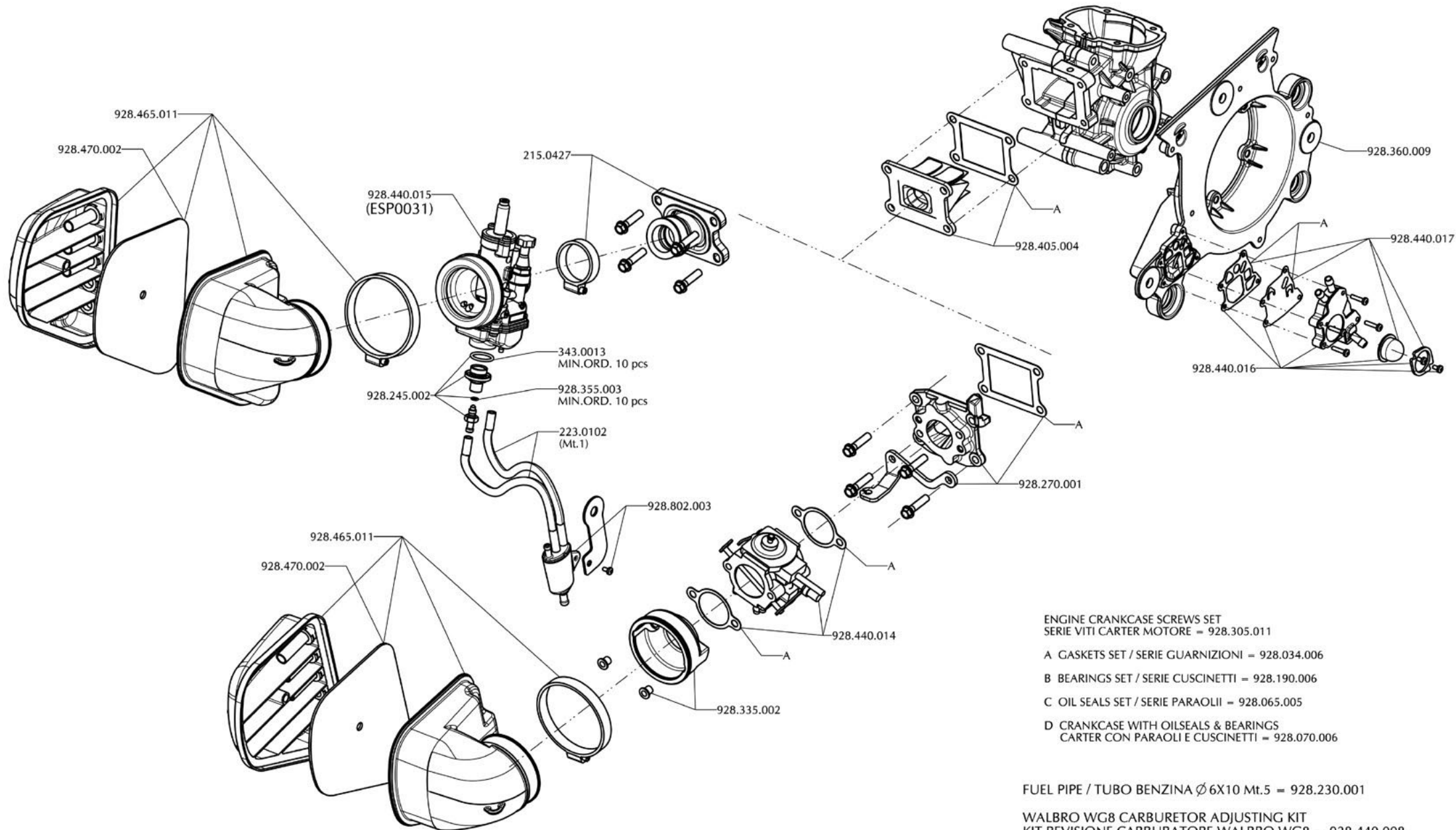

- ENGINE CRANKCASE SCREWS SET
 SERIE VITI CARTER MOTORE = 928.305.011
- A GASKETS SET / SERIE GUARNIZIONI = 928.034.006
- B BEARINGS SET / SERIE CUSCINETTI = 928.190.006
- C OIL SEALS SET / SERIE PARAOLII = 928.065.005
- D CRANKCASE WITH OILSEALS & BEARINGS
 CARTER CON PARAOLI E CUSCINETTI = 928.070.006

- FUEL PIPE / TUBO BENZINA Ø6X10 Mt.5 = 928.230.001
- WALBRO WG8 CARBURETOR ADJUSTING KIT
 KIT REVISIONE CARBURATORE WALBRO WG8 = 928.440.008
- MAIN JET / GETTO MASSIMO WG8 0,70 = 928.445.004

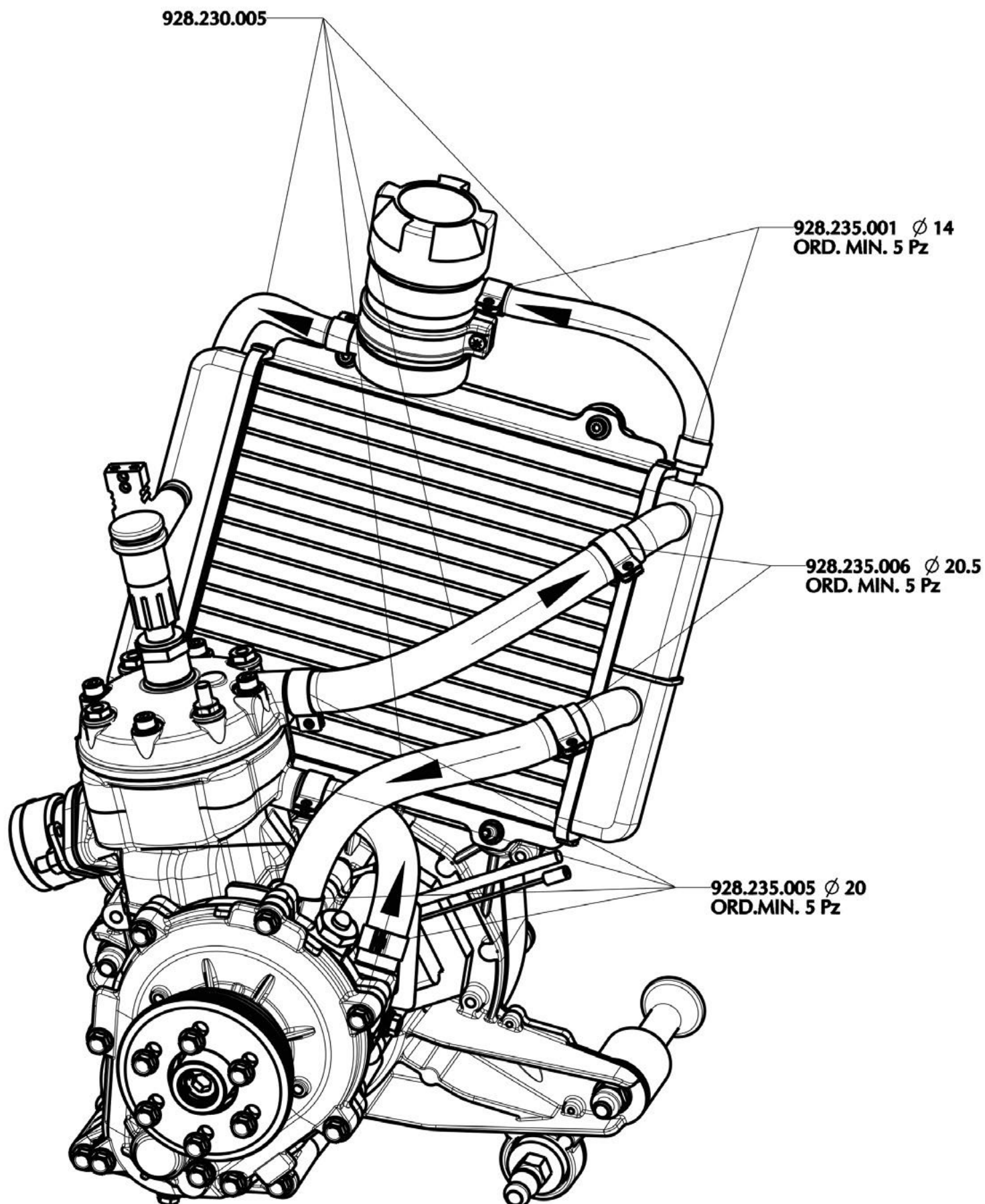

POLINI THOR80

CARBURETOR ADJUSTED WITH NEW AIR BOX ITEM 928.465.011

CARBURATORE TARATO CON NUOVA SCATOLA
FILTRO ARIA COD. 928.465.011

MINIMUM ORDER 5 pcs
ORDINE MINIMO 5 PEZZI

polini motori®
trasforma il meglio in massimo
THOR 80

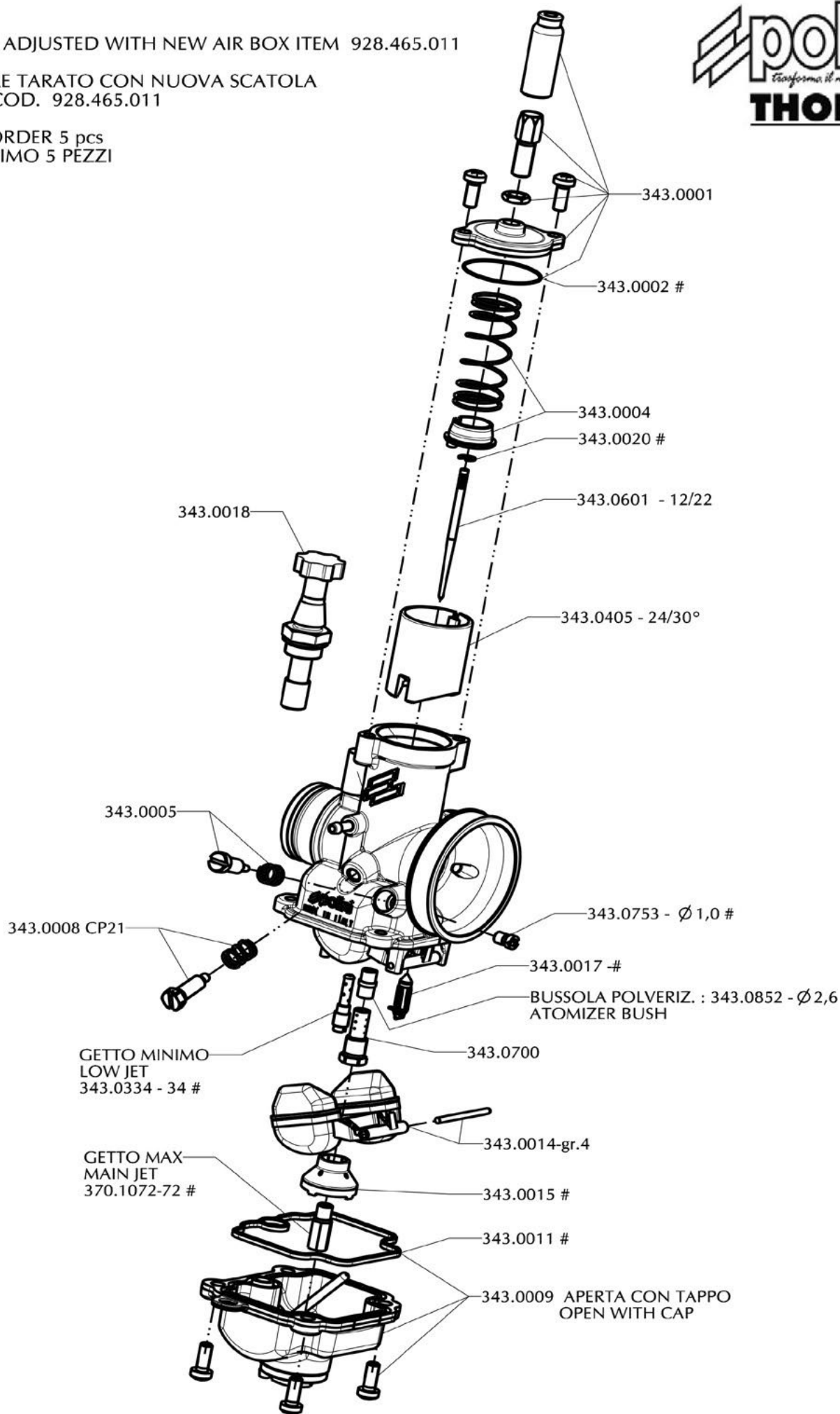

POLINI THOR130

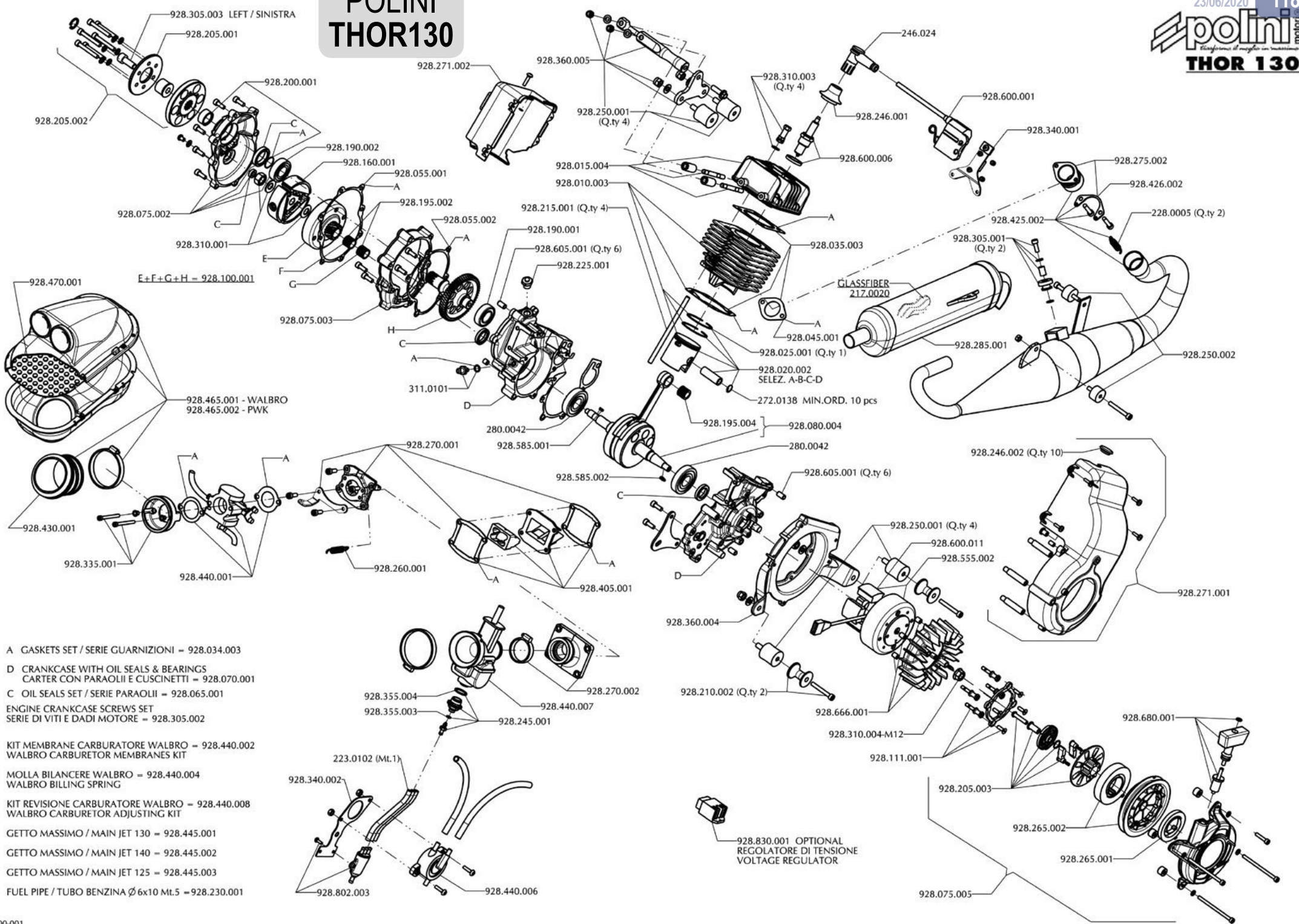

- A GASKETS SET / SERIE GUARNIZIONI = 928.034.003
- D CRANKCASE WITH OIL SEALS & BEARINGS
CARTER CON PARAOLII E CUSCINETTI = 928.070.001
- C OIL SEALS SET / SERIE PARAOLII = 928.065.001
- ENGINE CRANKCASE SCREWS SET
SERIE DI VITI E DADI MOTORE = 928.305.002
- KIT MEMBRANE CARBURATORE WALBRO = 928.440.002
WALBRO CARBURETOR MEMBRANES KIT
- MOLLA BILANCERE WALBRO = 928.440.004
WALBRO BILLING SPRING
- KIT REVISIONE CARBURATORE WALBRO = 928.440.008
WALBRO CARBURETOR ADJUSTING KIT
- GETTO MASSIMO / MAIN JET 130 = 928.445.001
- GETTO MASSIMO / MAIN JET 140 = 928.445.002
- GETTO MASSIMO / MAIN JET 125 = 928.445.003
- FUEL PIPE / TUBO BENZINA Ø6x10 Mt.5 = 928.230.001

POLINI THOR130 EVO

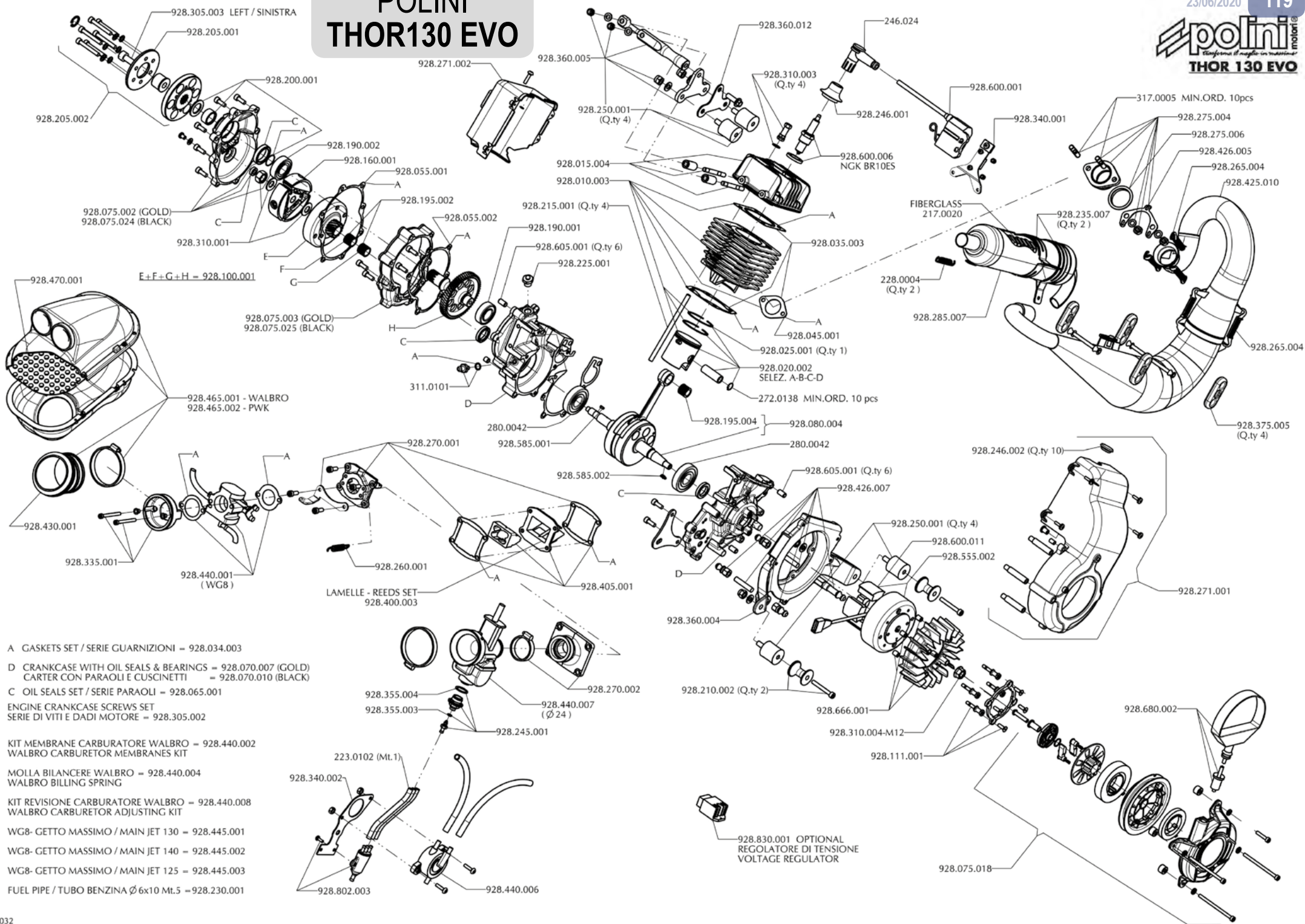

- A GASKETS SET / SERIE GUARNIZIONI = 928.034.003
- D CRANKCASE WITH OIL SEALS & BEARINGS = 928.070.007 (GOLD)
 CARTER CON PARAOLI E CUSCINETTI = 928.070.010 (BLACK)
- C OIL SEALS SET / SERIE PARAOLI = 928.065.001
- ENGINE CRANKCASE SCREWS SET
 SERIE DI VITI E DADI MOTORE = 928.305.002
- KIT MEMBRANE CARBURATORE WALBRO = 928.440.002
 WALBRO CARBURETOR MEMBRANES KIT
- MOLLA BILANCERE WALBRO = 928.440.004
 WALBRO BILLING SPRING
- KIT REVISIONE CARBURATORE WALBRO = 928.440.008
 WALBRO CARBURETOR ADJUSTING KIT
- WG8- GETTO MASSIMO / MAIN JET 130 = 928.445.001
- WG8- GETTO MASSIMO / MAIN JET 140 = 928.445.002
- WG8- GETTO MASSIMO / MAIN JET 125 = 928.445.003
- FUEL PIPE / TUBO BENZINA Ø 6x10 Mt.5 = 928.230.001

POLINI THOR190 LIGHT CLUTCH

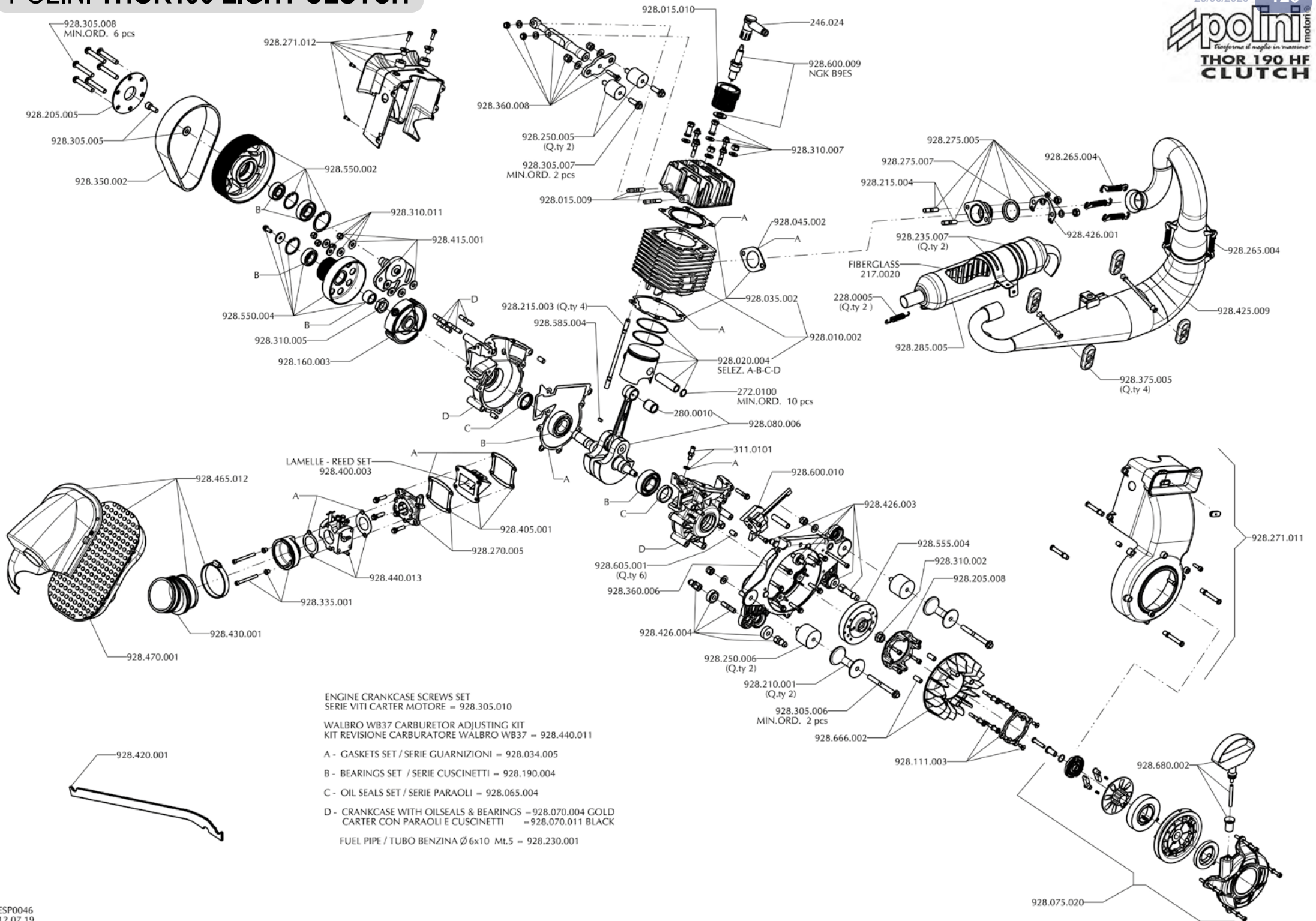

- ENGINE CRANKCASE SCREWS SET
SERIE VITI CARTER MOTORE = 928.305.010
- WALBRO WB37 CARBURETOR ADJUSTING KIT
KIT REVISIONE CARBURATORE WALBRO WB37 = 928.440.011
- A - GASKETS SET / SERIE GUARNIZIONI = 928.034.005
- B - BEARINGS SET / SERIE CUSCINETTI = 928.190.004
- C - OIL SEALS SET / SERIE PARAOLI = 928.065.004
- D - CRANKCASE WITH OILSEALS & BEARINGS = 928.070.004 GOLD
CARTER CON PARAOLI E CUSCINETTI = 928.070.011 BLACK
- FUEL PIPE / TUBO BENZINA Ø6x10 Mt.5 = 928.230.001

FROM ENGINE N° 4019
DAL MOTORE N° 4019

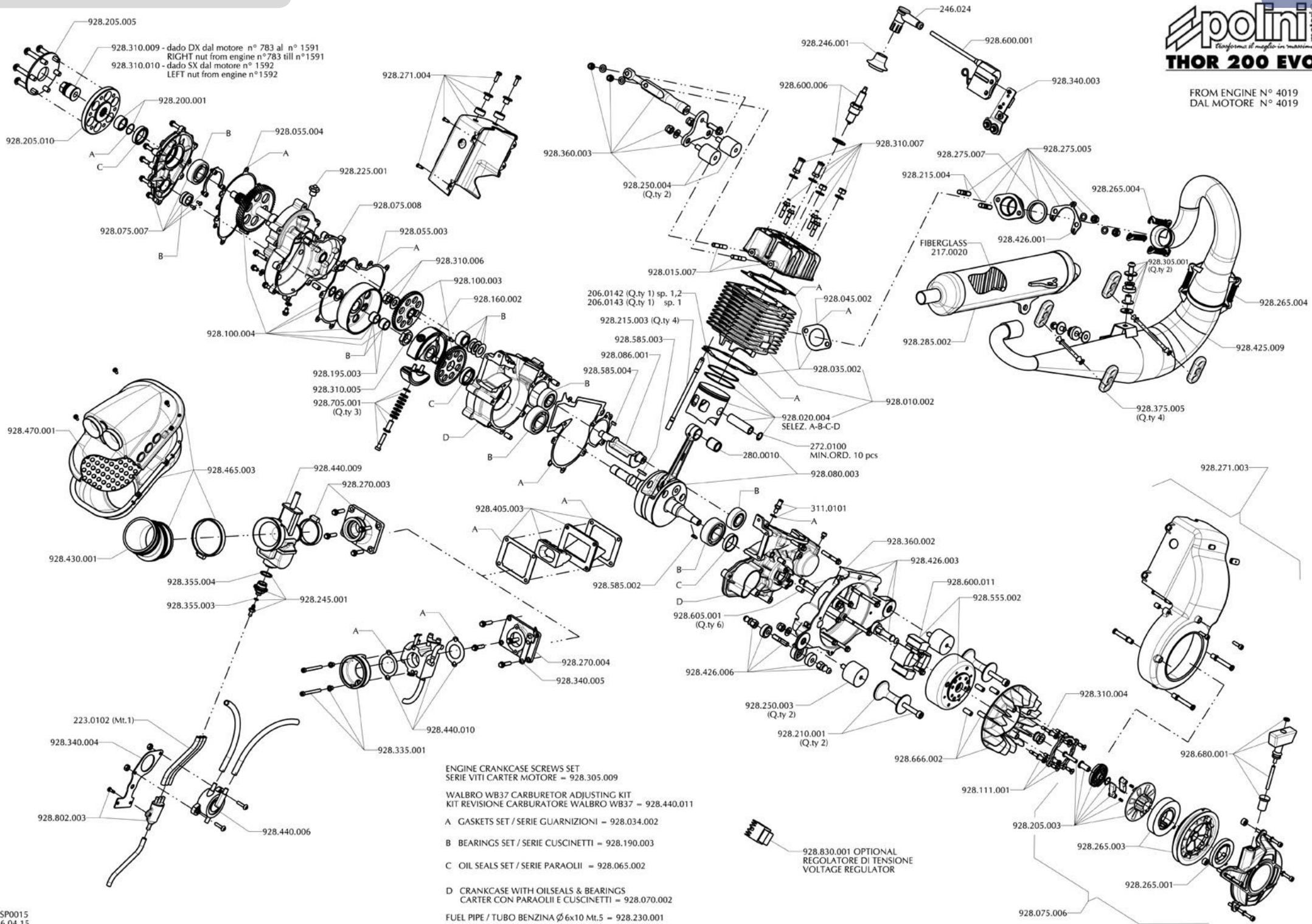

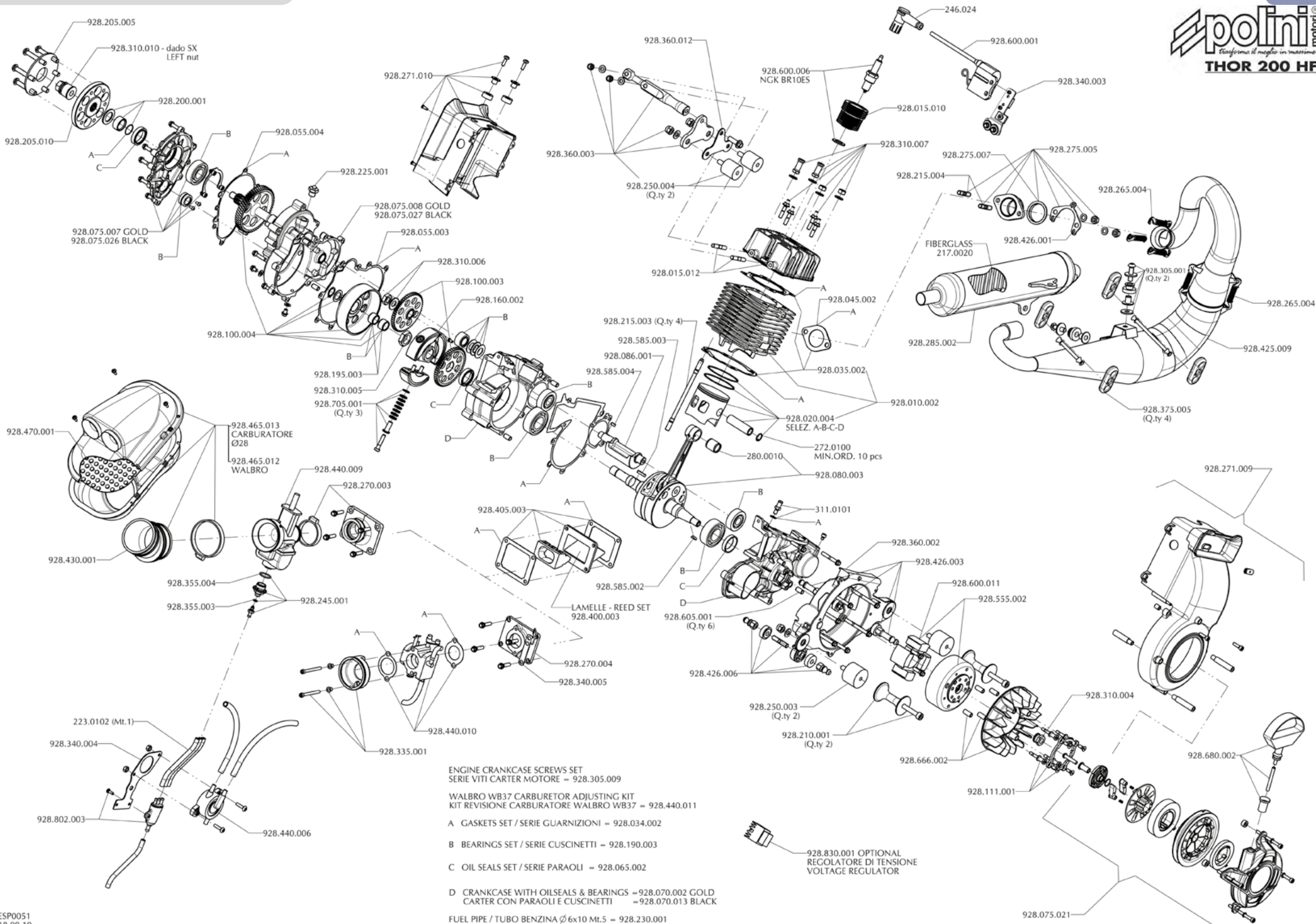

POLINI THOR250

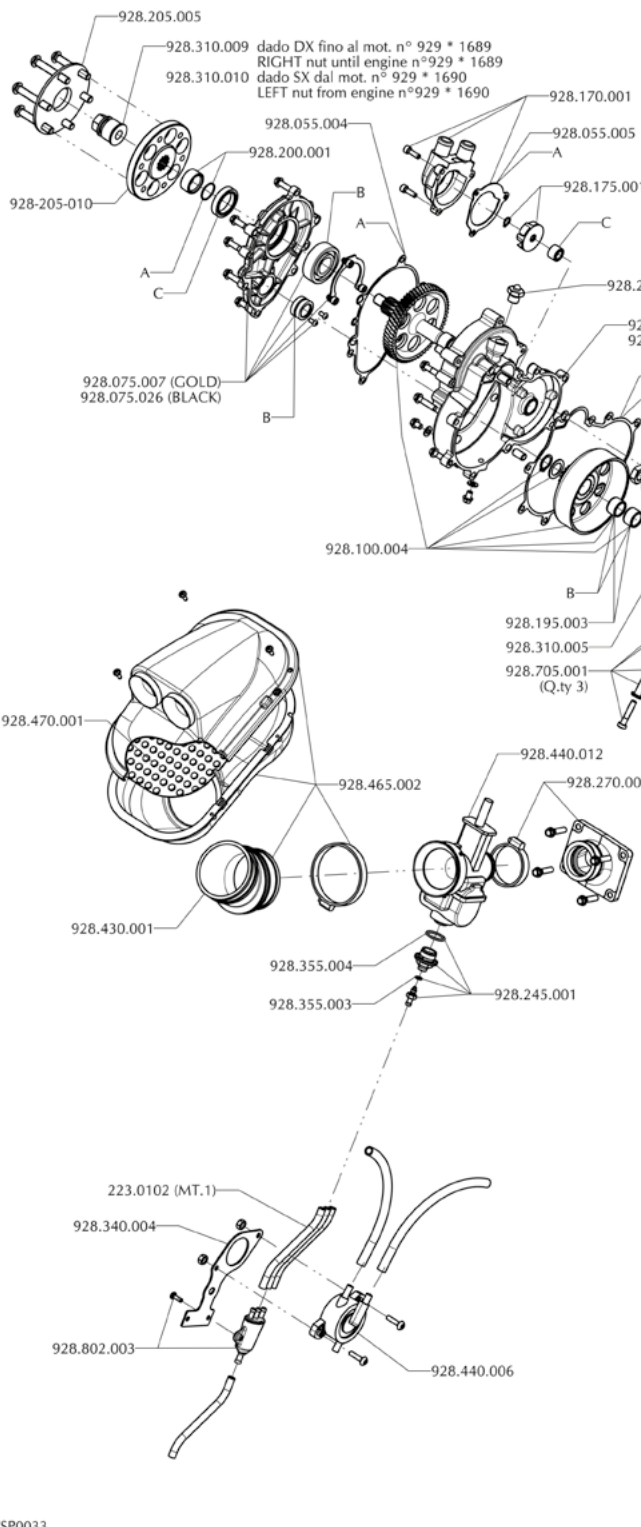
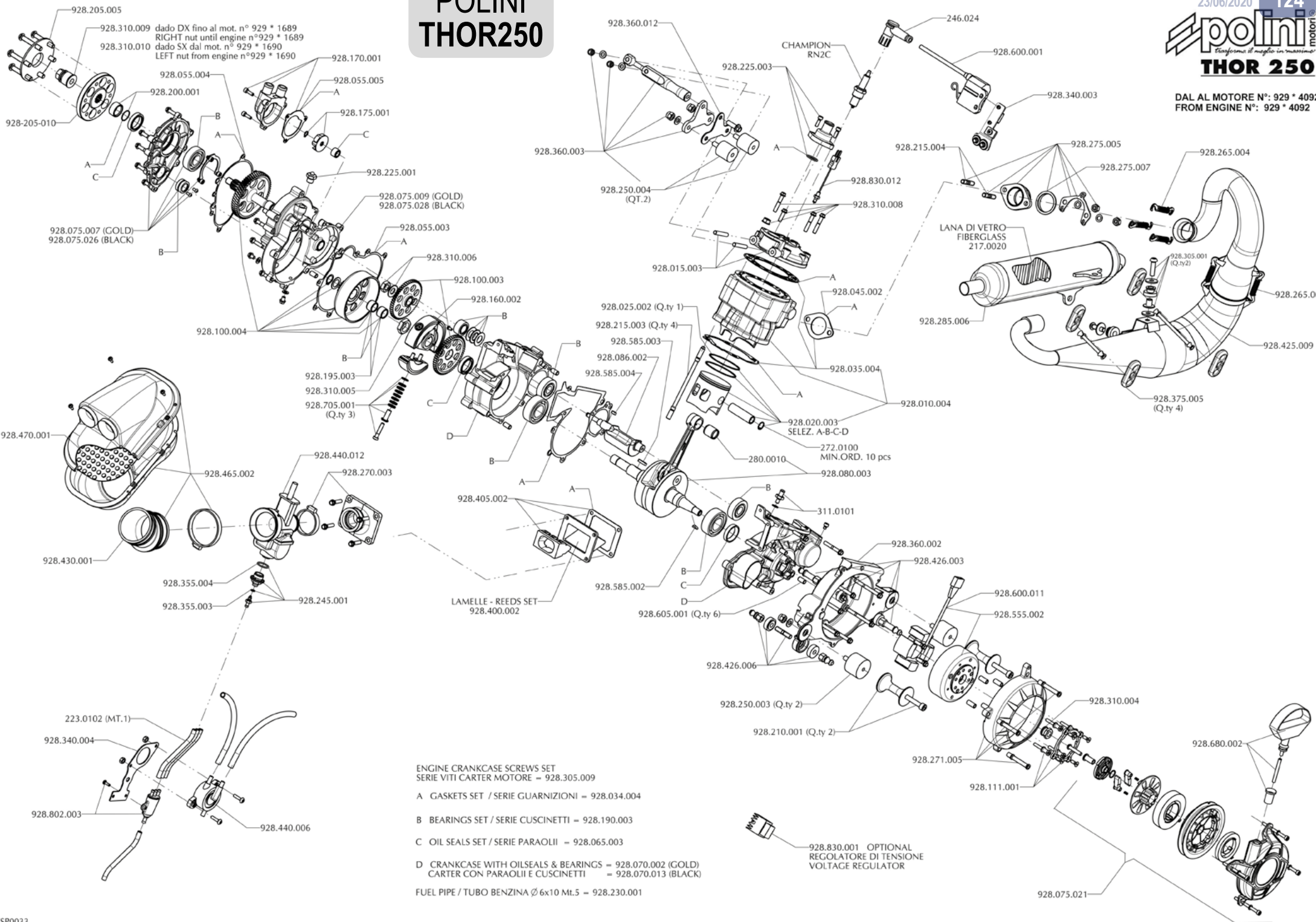

- ENGINE CRANKCASE SCREWS SET
SERIE VITI CARTER MOTORE = 928.305.009
- A GASKETS SET / SERIE GUARNIZIONI = 928.034.004
- B BEARINGS SET / SERIE CUSCINETTI = 928.190.003
- C OIL SEALS SET / SERIE PARAOLII = 928.065.003
- D CRANKCASE WITH OILSEALS & BEARINGS = 928.070.002 (GOLD)
CARTER CON PARAOLII E CUSCINETTI = 928.070.013 (BLACK)
- FUEL PIPE / TUBO BENZINA \varnothing 6x10 Mt.5 = 928.230.001

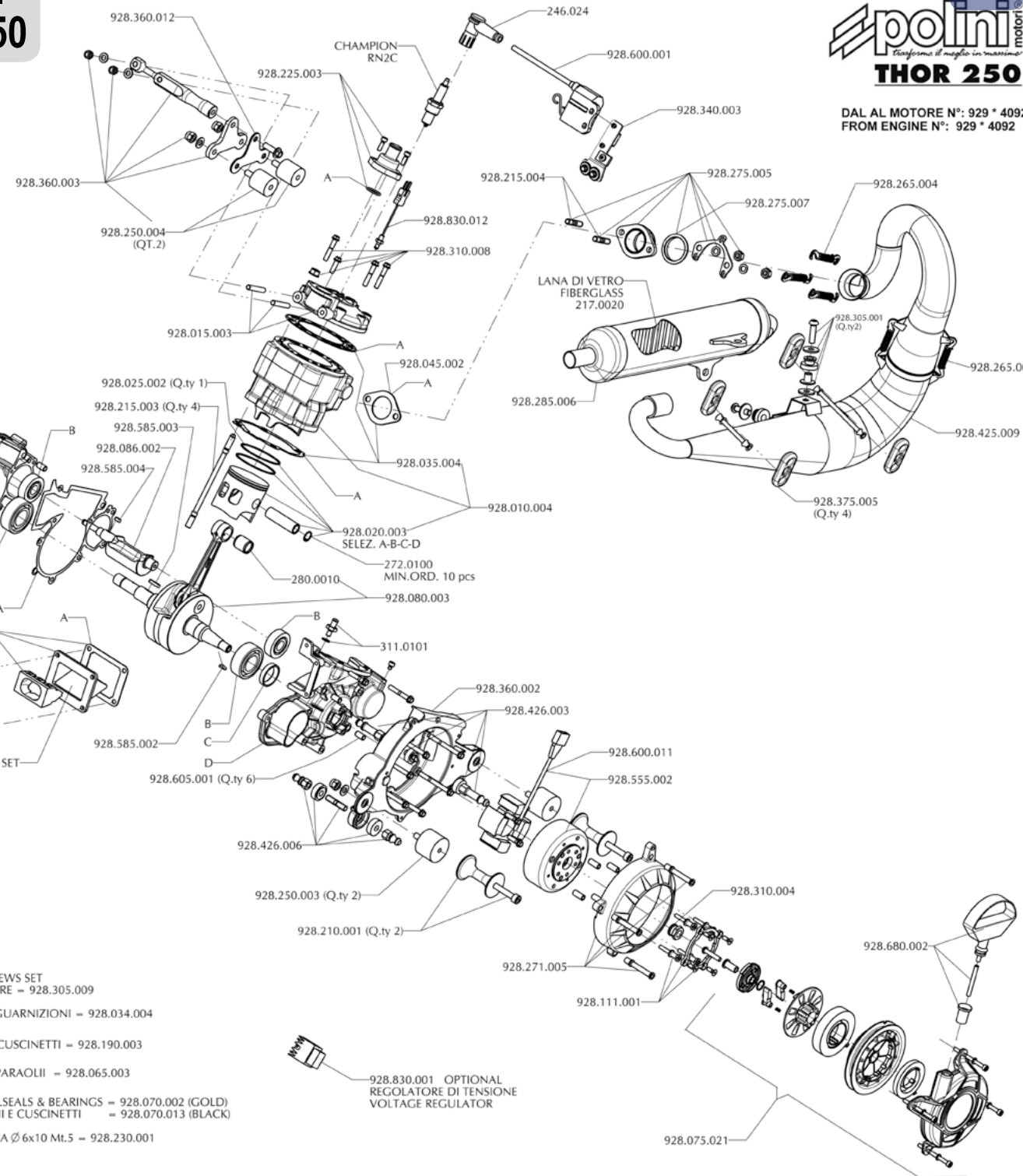

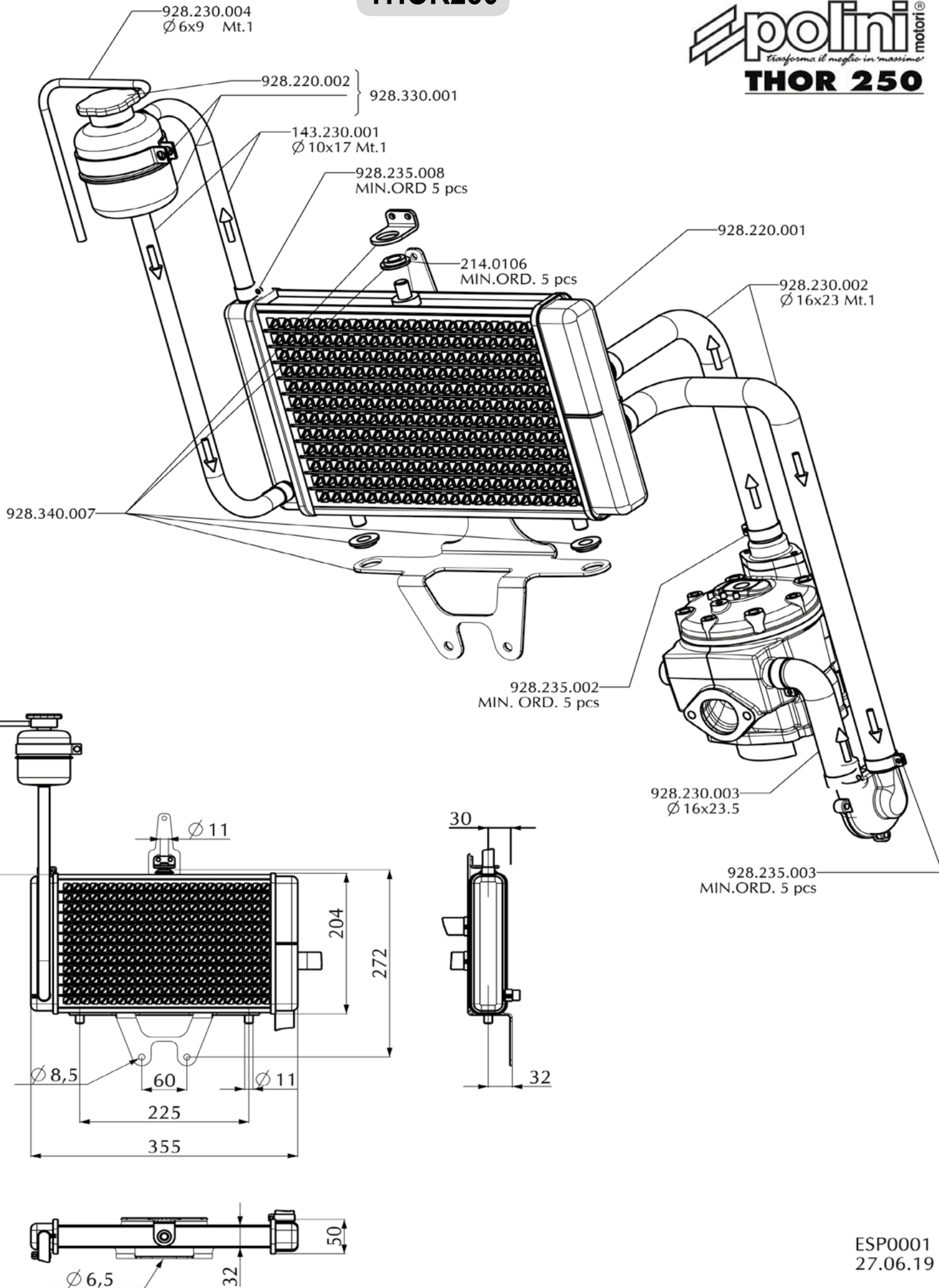

CARBURETORS Ø 24-26-28-30-32-34 | CARBURATORI



342.0106 Ø24-26-28-30
342.0120 Ø32-34



342.0108



343.0020



342.0111 Ø 24-26
342.0119 Ø 28
342.0118 Ø 30
342.0125 N68E Ø 32-34

343.0019



343.0018



342.0105 Ø24-26-28-30
342.0124 Ø32
342.0126 Ø34



342.0109 Ø24-26-28-30
342.0121 Ø32-34



342.0110 Ø 28-30 h10
342.0117 Ø 24-26 h11,2
342.0140 Ø 34 h11
342.0128 Ø 32 h12



342.0115 - 8 fori - holes
342.0112 - 20 fori - holes
342.0113 - 40 fori - holes
342.0127 - 30 fori - holes

MAIN JET - SLOW JET pag.277

342.0107 Ø24-26-28-30
342.0122 Ø32-34



342.0101



342.0102 Ø24-26-28-30
342.0123 Ø32-34



342.0103











343.0017



















144.480.001 Ø36



			80	130	190	200	250	PVP
	011.1095	PIEZA TRIANGULAR (KIT SOPORTE CULATA) PIÈCE RECTANGULAIRE (KIT SUPPORT CULASSE) TRIANGULAR PART (CYLINDER HEAD SUPPORT)						21,88 €
	011.2899	BULON DE PISTON PISTON BOULON AXE DE PISTON			X	X	X	6,25 €
	143.230.001	MANGUITO H2O D10X15 10 BAR RADIATOR HOSE D.10X15 DURITE H2O D.10X15 10BAR ISO 1307/83					X	10,41 €
	144.585.001	CHAVETA DE DISCO EMBRAGUE CLUTCH KEY WAY CLAVETTE D' EMBRAYAGE	X					1,25 €
	204.0900/A	PISTON MINARELLI AM6 D.50 A PISTON MINARELLI AM6 D.50 (A) PISTON MINARELLI AM6 D.50/A	X					87,92 €
	204.0900/B	PISTON MINARELLI AM6 D.50 B PISTON MINARELLI AM6 D.50 (B) PISTON MINARELLI AM6 D.50/B	X					87,92 €
	204.0900/C	PISTON MINARELLI AM6 D.50 C PISTON MINARELLI AM6 D.50 (C) PISTON MINARELLI AM6 D.50/C	X					87,92 €
	204.0900/D	PISTON MINARELLI AM6 D.50 D PISTON MINARELLI AM6 D.50 (D) PISTON MINARELLI AM6 D.50/D	X					87,92 €
	206.0142	SEGMENTO - THOR 200 - 1,2 mm. (1 ud.) PISTON RING - THOR 200 - 1,2 mm. (1 ud.) SEGMENT - THOR 200 - 1,2 mm.(1 ud.)					X	19,00 €
	206.0143	SEGMENTO - THOR 200 - 1 mm. (1 ud.) PISTON RING - THOR 200 - 1 mm. (1 ud.) SEGMENT - THOR 200 - 1 mm.(1 ud.)					X	19,72 €
	206.0327	SEGMENTO - THOR 80 (1 ud.) PISTON RING - THOR 80 (1 ud.) SEGMENT - THOR 80 (1 ud.)	X					18,89 €
	214.0106	GOMA ANTIVIBRATORIA PARA RADIADOR SILENT BLOCK ENTRETOISE PLAST.SUPP.RADIATEUR					X	1,26 €
	215.0427	COLECTOR ADM. THOR 80 CARB. PWK D.21 INTAKE MANIFOLD THOR 80 CARB. PWK D.21 PIPE ADMIS. THOR 80 CARB.PWK D.21	X					50,50 €
	217.0020	FIBRA SILENCIADOR SILENCER FIBER FIBRE SILENCIEUX	X	X	X	X	X	20,56 €
	223.0102	TUBO PARA VACIO 4X8 TUBE 4X8 (AT METER) DURITE 4X8 (AU METRE)	X	X		X	X	5,00 €
	228.0001	MUELLE LARGO TUBO DESCARGA EXHAUST PIPE SPRING LONG RESSORT POT LONG	X					1,39 €
	228.0004	MUELLE DE TRACCION INOX L= 53 TRACTION SPRING INOX L=53 RESSORT DE TRACTION INOX L=53			X			7,21 €
	228.0005	MUELLE DE TRACCION INOX L= 67 TRACTION SPRING INOX L=67 RESSORT DE TRACTION INOX L=67			X			7,67 €
	228.0007	MUELLE DE TRACCION INOX f.2 (1 ud.) TRACTION SPRING INOX f.2 (1 unit) RESSORT DE TRACTION INOX f.2 (1 un.)			X	X	X	3,12 €
	246.024	PIPETA SPARK PLUG CAP PIPETTE	X	X	X	X	X	15,87 €

	272.0001	CLIPS DEL BOULON - THOR 80 (2 UNIDADES) BOULON CLIPS - THOR 80 (2 UNITIES) CLIPS DE BOULONS - THOR 80 (2 UNITÉES)	X						4,00 €
	280.0010	COJINETE PISTON PISTON BEARING ROULEMENT PISTON			X	X	X		18,10 €
	280.0012	COJINETE PISTON THOR 80 PISTON BEARING THOR 80 ROULEMENT PISTON THOR 80	X						8,45 €
	280.0042	COJINETE CARTER MOTOR PIAGGIO ENGINE CRANKCASE BEARING ROULEMENT CARTER PIAGGIO		X					26,55 €
	311.0101	UNION 6X1 INLET 6X1 RACCORD D.6X1	X	X	X	X	X		1,05 €
	317.0005	ESPARRAGO DESCARGA M6 X 32 EXHAUST STUD 6X32 GOUJON ECHAPPEMENT M6X32	X						3,00 €
	928.004.003	KIT THOR 200 CARB.28 "HF" (Culata, Carburador, Airbox, Spark Cooler, Carcasa "HF") KIT THOR 200 CARB.28 "HF" (Head cylinder, Carburetor, Air Box, Spark cooler, "HF Cover") KIT THOR 200 CARB.28 "HF" (Culasse, Carburateur, boîte à air, Spark cooler, "HF" Cover)					X		315,44 €
	928.004.004	KIT THOR 190 "HF" (Culata, Spark Cooler, Carcasa "HF") KIT THOR 190 "HF" (Head cylinder, Spark cooler, "HF Cover") KIT THOR 190 "HF" (Culasse, Spark cooler, "HF" Cover)				X			101,39 €
	928.004.010	THOR SERVICE KIT 190 THOR SERVICE KIT 190 THOR SERVICE KIT 190							184,84 €
	928.004.011	THOR SERVICE KIT 200 THOR SERVICE KIT 200 THOR SERVICE KIT 200							152,03 €
	928.004.012	THOR SERVICE KIT 202-250 THOR SERVICE KIT 202-250 THOR SERVICE KIT 202-250							152,03 €
	928.010.002	CILINDRO COMPLETO D.64 THOR 190/200 COMPLETE CYLINDER D.64 THOR 190/200 CYLINDRE COMPLET D.64 THOR 190/200			X	X			352,58 €
	928.010.003	CILINDRO COMPLETO D.54 THOR 130 COMPLETE CYLINDER D.54 THOR 130 CYLINDRE COMPLETE D.54 THOR 130		X					346,62 €
	928.010.004	CILINDRO COMPLETO D.72 THOR 250 LC COMPLETE CYLINDER D.72 THOR 250 LC CYLINDRE COMPLET D.72 THOR 250 LC					X		382,46 €
	928.010.005	CILINDRO COMPLETO D.50 THOR 80 COMPLETE CYLINDER D.50 THOR 80 CYLINDRE COMPLET D.50 THOR 80	X						301,92 €
	928.010.007	CILINDRO COMPLETO D.64 THOR 202 COMPLETE CYLINDER D.64 THOR 202 CYLINDRE COMPLET D.64 THOR 202							359,84 €
	928.015.003	CULATA THOR 250 LC HEAD THOR 250 LC CULASSE THOR 250 LC					X		101,60 €
	928.015.004	CULATA AIRE THOR 130 A/C HEAD THOR 130 CULASSE AIR THOR 130		X					50,20 €
	928.015.006	KIT MODIFICA CULATA AIRE THOR 200 A/C HEAD MODIFICATION KIT THOR 200 MODIFICATION CULASSE AIR THOR 200							105,19 €
	928.015.007	CULATA AIRE THOR 190/200 HEAD A/C THOR 190/200 CULASSE AIR THOR 190/200			X	X			53,80 €







	928.015.008	CULATA AIRE THOR 80 HEAD A/C THOR 80 CULASSE AIR THOR 80	X						73,23 €
	928.015.009	CULATA THOR 190 HF HEAD THOR 190 HF CULASSE THOR 190 HF							54,08 €
	928.015.011	CULATA THOR 202 HEAD THOR 202 CULATA THOR 202							103,91 €
	928.015.012	CULATA THOR 200 HF HEAD THOR 200 HF CULASSE THOR 200 HF							54,08 €
	928.020.001/A	PISTON D.52 - A PISTON D.52 - A PISTON D.52 - A							141,95 €
	928.020.001/B	PISTON D.52 - B PISTON D.52 - B PISTON D.52 - B							141,95 €
	928.020.001/C	PISTON D.52 - C PISTON D.52 - C PISTON D.52 - C							141,95 €
	928.020.001/D	PISTON D.52 - D PISTON D.52 - D PISTON D.52 - D							141,95 €
	928.020.002/A	PISTON D.54 LETRA A (53,97) PISTON D.54 SELECTION A (53,97) PISTON D.54 SELECTION A (53,97)		X					117,13 €
	928.020.002/B	PISTON D.54 LETRA B (53,98) PISTON D.54 SELECTION B (53,98) PISTON D.54 SELECTION B (53,98)		X					117,13 €
	928.020.002/C	PISTON D.54 LETRA C (53,99) PISTON D.54 SELECTION C (53,99) PISTON D.54 SELECTION C (53,99)		X					117,13 €
	928.020.002/D	PISTON D.54 LETRA D (54,00) PISTON D.54 SELECTION D (54,00) PISTON D.54 SELECTION D (54,00)		X					117,13 €
	928.020.003/A	PISTON D.72 LETRA A (71,94) PISTON D.72 SELECTION A (71,94) PISTON D.72 SELECTION A (71,94)						X	150,61 €
	928.020.003/B	PISTON D.72 LETRA B (71,95) PISTON D.72 SELECTION B (71,95) PISTON D.72 SELECTION B (71,95)						X	150,61 €
	928.020.003/C	PISTON D.72 LETRA C (71,96) PISTON D.72 SELECTION C (71,96) PISTON D.72 SELECTION C (71,96)						X	150,61 €
	928.020.003/D	PISTON D.72 LETRA D (71,97) PISTON D.72 SELECTION D (71,97) PISTON D.72 SELECTION D (71,97)						X	150,61 €
	928.020.004/A	PIST.CAGIVA-GILERA D.64 LETRA A PISTON CAGIVA-GILERA D.64 (A) PISTON CAGIVA-GILERA D.64/A				X	X		118,29 €
	928.020.004/B	PIST.CAGIVA-GILERA D.64 LETRA B PISTON CAGIVA-GILERA D.64 (B) PISTON CAGIVA-GILERA D.64/B				X	X		118,29 €
	928.020.004/C	PIST.CAGIVA-GILERA D.64 LETRA C PISTON CAGIVA-GILERA D.64 (C) PISTON CAGIVA-GILERA D.64/C				X	X		118,29 €
	928.020.004/D	PIST.CAGIVA-GILERA D.64 LETRA D PISTON CAGIVA-GILERA D.64 (D) PISTON CAGIVA-GILERA D.64/D				X	X		118,29 €

			80	130	190	200	250	PVP
	928.020.005/A	PISTON D.66 SEL.A (65,94) THOR 202 PISTON D.66 SEL.A (65,94) THOR 202 PISTON D.66 SEL.A (65,94) THOR 202						137,81 €
	928.020.005/B	PISTON D.66 SEL.B (65,94) THOR 202 PISTON D.66 SEL.B (65,94) THOR 202 PISTON D.66 SEL.B (65,94) THOR 202						137,81 €
	928.020.005/C	PISTON D.66 SEL.C (65,94) THOR 202 PISTON D.66 SEL.C (65,94) THOR 202 PISTON D.66 SEL.C (65,94) THOR 202						137,81 €
	928.020.005/D	PISTON D.66 SEL.D (65,94) THOR 202 PISTON D.66 SEL.D (65,94) THOR 202 PISTON D.66 SEL.D (65,94) THOR 202						137,81 €
	928.025.001	SEGMENTO - THOR 130 (1 ud.) PISTON RING - THOR 130 (1 ud.) SEGMENT - THOR 130 (1 ud.)		X				15,77 €
	928.025.002	SEGMENTO - THOR 250 (1 ud.) PISTON RING - THOR 250 (1 ud.) SEGMENT - THOR 250 (1 ud.)					X	21,40 €
	928.034.002	JUNTAS (JUEGO) MOTOR A/C THOR 200 GASKET SET A/C THOR 200 ENGINE JOINT (POCH) MOTEUR A AIR THOR 200				X		19,15 €
	928.034.003	JUNTAS (JUEGO) MOTOR A/C THOR 130 GASKET SET A/C THOR 130 ENGINE JOINTS (JEU) MOTEUR A/C THOR 130		X				20,28 €
	928.034.004	JUNTAS (JUEGO) MOTOR L/C THOR 250 GASKET SET L/C THOR 250 ENGINE JOINT (POCH) MOTEUR A EAU THOR 250 LC					X	23,33 €
	928.034.005	JUNTAS MOTOR THOR 190 GASKET SET THOR 190 ENGINE JOINTS MOTEUR THOR 190			X			18,57 €
	928.034.006	JUEGO DE JUNTAS MOTOR THOR 80 GASKET SET THOR 80 JOINTS (POCH.) MOTEUR THOR 80						22,53 €
	928.035.002	JUNTAS (JUEGO) CILINDRO A/C CYLINDER GASKETS A/C JOINT (POCH) CYLINDRE A/C			X	X		8,62 €
	928.035.003	JUNTAS (JUEGO) CILINDRO A/C THOR 130 CYLINDER GASKETS THOR 130 A/C JOINTS (JEU) CILINDRE A/C THOR 130		X				9,01 €
	928.035.004	JUNTAS (JUEGO) CILINDRO L/C THOR 250 CYLINDER GASKETS THOR 250 L/C JOINT (POCH) CYLINDRE L/C THOR 250					X	10,76 €
	928.035.006	JUNTA EMBASE CILINDRO THOR 200 S.0,5 AL. BASE GASKET FOR CYLINDER THOR 200 JOINT D'EMBASE CYLINDRE THOR 200					X	3,12 €
	928.035.007	JUNTAS (JUEGO) CILINDRO L/C THOR 80 CYLINDER GASKETS THOR 80 JOINT (POCH) CYLINDRE L/C THOR 80	X					9,01 €
	928.035.008	JUNTAS CILINDRO THOR 202 GASKETS FOR CYLINDER THOR 202 JOINTS (POCH) CYLINDRE THOR 202						10,94 €
	928.045.001	JUNTA DESCARGA ESCAPE EXHAUST GASKET JOINT D'ÉCHAPPEMENT	X	X				4,29 €
	928.045.002	JUNTA DESCARGA ESCAPE EXHAUST GASKET JOINT D'ÉCHAPPEMENT			X	X	X	2,17 €
	928.055.001	JUNTA CARTER EMBRAGUE CLUTCH CASE GASKET JOINT CARTER D'EMBRAYAGE		X				1,80 €
	928.055.002	JUNTA CARTER REDUCTORA GEAR CASE REDUCTION GASKET JOINT CARTER REDUCTION ENGRENAGE		X				1,21 €





	928.055.003	JUNTA CARTER GASKET FOR MIDDLE CASE JOINT CARTER				X	X	3,36 €
	928.055.004	JUNTA CARTER TRANSM. GASKET FOR TRANSM. CASE JOINT CARTER TRANSM.				X	X	3,13 €
	928.055.005	JUNTA TAPA BOMBA THOR 250 LC PUMP COVER GASKET THOR 250 LC JOINT COUVERCLE POMPE THOR 250 LC					X	1,44 €
	928.055.006	JUNTA TAPA BOMBA THOR 80 PUMP COVER GASKET THOR 80 JOINT COUVERCLE POMPE THOR 80	X					2,03 €
	928.055.007	JUNTA CARTER TRANSM. THOR 80 GASKET FOR TRANSM. CASE THOR 80 JOINT CARTER TRANSM. THOR 80	X					3,38 €
	928.065.001	RETENES MOTOR ENGINE OILSEALS SET JOINTS SPY MOTEUR		X				37,18 €
	928.065.002	RETENES MOTOR THOR 200 OIL SEALS FOR THOR ENGINE 200 JOINTS SPY MOTEUR THOR 200				X		13,76 €
	928.065.003	CONJUNTO RETENES MOTOR THOR 250 LC OIL SEALS THOR 250 LC ENGINE JOINTS MOTEUR THOR 250 LC					X	19,13 €
	928.065.004	CONJUNTO RETENES MOTOR THOR 190 OIL SEAL SET THOR 190 ENGINE JOINT SPY MOTEUR THOR 190			X			13,35 €
	928.065.005	JUEGO RETENES MOTOR THOR 80 LC ENGINE OIL SEAL THOR 80 LC JOINTS SPY MOTEUR THOR 80 LC						18,03 €
	928.070.001	PAREJA CARTER CENTRAL CENTRAL CASES PAIRE CARTER CENTRALE		X				327,97 €
	928.070.002	CARTER CENTRAL THOR 200-250 CENTRAL CASE THOR 200-250 PAIRE CARTER CENTRALE THOR 200-250				X	X	339,43 €
	928.070.005	PAREJA CARTER CENTRAL THOR 190 CENTRAL CASES THOR 190 PAIRE CARTER CENTRALE THOR 190			X			278,49 €
	928.070.006	PAREJA CARTER CENTRAL THOR 80 LC CENTRAL CASES THOR 80 LC PAIRE CARTER CENTRALES THOR 80 LC						214,05 €
	928.070.007	PAREJA CARTER CENTRALES THOR 130 EVO PAIR OF CENTRAL CRANKCASES THOR 130 EVO COUPLE CARTER CENTRAUX THOR 130 EVO						328,96 €
	928.075.002	CARTER EMBRAGUE CLUTCH CASE CARTER D'EMBRAYAGE		X				92,28 €
	928.075.003	CARTER TRANSMISION TRANSMISSION CASE CARTER TRANSMISSION						59,77 €
	928.075.004	CARTER ARRANQUE EN ALUMINIO MANUAL STARTER - ALUMINIUM CARTER DEMARRAGE EN ALUMINIUM	X	X	X	X	X	104,60 €
	928.075.005	CARTER ENCENDIDO THOR 100/130 (FLASH STARTER) STARTER CASE THOR 80 (FLASH STAR) CARTER DEMARRAGE THOR 100/130 (FLASH STARTER)		X				155,38 €
	928.075.007	CARTER EMBRAGUE CLUTCH CASE CARTER ALLUMAGE				X	X	103,98 €
	928.075.008	CARTER TRANSMISION THOR 200 TRANSMISSION CASE THOR 200 CARTER TRANSMISSION THOR 200				X		69,33 €

928.075.009	CARTER TRANSMISION THOR 250 LC TRANSMISSION CASE THOR 250 LC CARTER TRANSMISSION THOR 250 LC								X	70,53 €
928.075.010	CARTER MOTOR ARRANQUE THOR 190 IGNITION ENGINE CASE THOR 190 CARTER SUPPORT MOTEUR ALLUMAGE									65,34 €
928.075.011	CARTER TRANSMISION THOR 80 TRANSMISSION CASE THOR 80 CARTER TRANSMISSION THOR 80	X								78,86 €
928.075.012	CARTER MEDIO THOR 80 MIDDLE CASE THOR 80 CARTER MOYEN THOR 80	X								73,23 €
928.075.014	CARTER ARRANQUE THOR 190 STARTER CASE THOR 190 CARTER ALLUMAGE THOR 130 EVO	X								104,60 €
928.075.016	CARTER ENCENDIDO THOR 80 FLASH STARTER STARTER CASE THOR 80 FLASH STARTER CARTER DEMARRAGE THOR 80 (FLASH STARTER)									155,38 €
928.075.017	CARTER ARRANQUE EN ALUMINIO MANUAL STARTER - ALUMINIUM CARTER DEMARRAGE EN ALUMINIUM									104,60 €
928.075.018	ARRANQUE THOR 100/130 (FLASH STARTER) FLASH STARTER CASE THOR 100/130 CARTER DEMARRAGE THOR 100/130 (FLASH STARTER)									160,17 €
928.075.019	CARTER ARRANQUE THOR 190 STARTER CASE THOR 190 CARTER ALLUMAGE THOR 130 EVO									104,60 €
928.075.020	CARTER ARRANQUE THOR 190 EMBRAGUE (FLASH STARTER) FLASH STARTER CASE THOR 190 CLUTCH CARTER DEMARREUR THOR 190 EMBRAYAGE (FLASH STARTER)									160,17 €
928.075.021	CARTER ARRANQUE THOR 200 STARTER CASE THOR 200 CARTER DEMARRAGE THOR 200/250									160,17 €
928.075.022	CARTER TRANSMISION THOR 80 LC TRANSMISSION BOX THOR 80 LC CARTER TRANSMISSION THOR 80 LC									78,86 €
928.075.023	CARTER MEDIO THOR 80 LC MIDDLE CASE THOR 80 LC CARTER MOYEN THOR 80 LC									73,23 €
928.075.024	CARTER EMBRAGUE CLUTCH CASE CARTER EMBRAYAGE									92,28 €
928.075.025	CARTER TRANSMISION TRANSMISSION CASE CARTER TRANSMISSION									59,77 €
928.075.026	CARTER EMBRAGUE THOR 200 CLUTCH CASE THOR 200 CARTER ALLUMAGE THOR 200									103,98 €
928.075.027	CARTER TRANSMISION THOR 200 TRANSMISSION CASE THOR 200 CARTER TRANSMISSION THOR 200									69,33 €
928.075.028	CARTER TRANSMISION THOR 250 LC CARTER TRANSMISION THOR 250 LC CARTER TRANSMISION THOR 250 LC									70,53 €
928.080.003	CIGUEÑAL CRANKSHAFT VILEBREQUIN							X	X	365,73 €
928.080.004	CIGUENAL THOR 130 CRANKSHAFT THOR 130 VILEBREQUIN THOR 130			X						337,05 €
928.080.006	CIGUENAL THOR 190 - EMBRAGUE CRANKSHAFT THOR 190 - CLUTCH EMBIELLAGE THOR 190 - EMBRAYAGE					X				336,51 €







			80	130	190	200	250	PVP
	928.080.008	CIGUENAL THOR 190 ARR.ELECT./EMBRAGUE CRANKSHAFT THOR 190 ELE.STARTER/CLUTCH EMBIELLAGE THOR 190 ALL.ELECT./EMBRAYAGE						336,51 €
	928.080.009	CIGUENAL THOR 80 CRANKSHAFT THOR 80 VILEBREQUIN THOR 80	X					279,39 €
	928.080.010	CIGUENAL THOR 202 CRANKSHAFT THOR 202 EMBIELLAGE THOR 202						352,19 €
	928.086.001	ARBOL DE EQUILIBRIO THOR 200 BALANCING SHAFT THOR 200 ARBRE DE BALANCEMENT THOR 200				X		77,69 €
	928.086.002	ARBOL DE EQUILIBRIO THOR 250 LC BALANCING SHAFT THOR 250 LC ARBRE DE BALANCEMENT THOR 250 LC					X	89,64 €
	928.100.001	EJE DE TRANSMISION CON CAMPANA EMB. TRANSMISSION SHAFT WITH CLUTCH BELL ARBRE DE TRANSM. AVEC CLOCHE EMBR.		X				186,46 €
	928.100.003	ENGRANAJES ARBOL DE EQUI. BAL. SHAFT GEARS ENGRENAGES ARBRE DE BAL.				X	X	110,57 €
	928.100.004	ARBOL DE TRANSM. CON CAMPANA TRANSMISSION SHAFT WITH BELL ARBRE DE TRANSM. AVEC CLOCHE				X	X	218,73 €
	928.100.005	ENGRANAJES ARBOL DE BALANCEO THOR 250 DUAL SPA GEARS FOR BAL. SHAFT THOR 250 DUAL SPARK ENGRENAGES ARBRE DE BAL. THOR 250 DUAL				X		128,80 €
	928.100.006	ENGRANAJE PRIMARIO THOR 80 PRIMARY GEAR THOR 80 ENGRENAGE PRIMAIRE THOR 80	X					150,51 €
	928.111.001	PLANCHAS ARRANQUE CON TORNILLOS STARTER BITE PLATE WITH SCREWS PLAQUE EMBRAYAGE DEMARRAGE AVEC VIS		X		X	X	22,49 €
	928.111.002	PLANCHAS ARRANQUE CON TORNILLOS THOR 190 STARTER BITE PLATE WITH SCREWS THOR 190 STARTER BITE PLATE WITH SCREWS THOR 190						22,49 €
	928.111.003	PLANCHAS ARRANQUE CON TORNILLOS - EMBRAGUE STARTER BITE PLATE WITH SCREWS - CLUTCH PLAQUE EMBRAYAGE DEMARRAGE AVEC VIS - EMBRAY.			X			22,49 €
	928.111.004	PLANCHAS ARRANQUE CON TORNILLOS THOR 190 - A.E STARTER BITE PLATE WITH SCREWS THOR 190 - E.S. PLAQUE EMBRAYAGE DEMARRAGE AVEC VIS THOR 190						22,49 €
	928.111.005	PLANCHAS ARRANQUE CON TORNILLOS THOR 80 STARTER BITE PLATE WITH SCREWS THOR 80 PLAQUE EMBRAYAGE DEMARRAGE AVEC VIS THOR 80	X					22,49 €
	928.145.001	CAMPANA EMBRAGUE THOR 80 CLUTCH BELL THOR 80 CLOCHE EMBRAYAGE THOR 80	X					95,76 €
	928.160.001	EMBRAGUE COMPLETO COMPLETE CLUTCH EMBRAYAGE COMPLETE		X				83,08 €
	928.160.002	EMBRAGUE COMPLETO COMPLETE CLUTCH EMBRAYAGE COMPLET				X	X	101,60 €
	928.160.003	EMBRAGUE COMPLETO THOR 190 COMPLETE CLUTCH THOR 190 EMBRAYAGE COMPLET THOR 190			X			101,39 €
	928.160.004	EMBRAGUE COMPLETO THOR 80 COMPLETE CLUTCH THOR 80 EMBRAYAGE COMPLET THOR 80	X					81,11 €
	928.170.001	TAPA BOMBA DE AGUA THOR 250 LC WATER PUMP COVER THOR 250 LC COUVERCLE POMPE A EAU THOR 250 LC					X	14,95 €





	928.205.008	BRIDA PARA VENTILADOR THOR 190 FLANGE FOR COOLING FAN THOR 190 PIPE SUPPORT VENTILATEUR THOR 190			X				16,25 €
	928.205.009	BRIDA PARA MOTOR ARRANQUE THOR 190 FLANGE FOR INJECTION ENGINE THOR 190 PIPE SUPPORT MOTEUR DEMARRAGE THOR 190							28,79 €
	928.205.010	BRIDA HELICE THOR 200/250 PROPELLER'S FLANGE THOR 200/250 PIPE HELICE THOR 200/250				X	X		36,67 €
	928.205.011	BRIDA SOPORTE VENTILADOR THOR 80 FLANGE FOR COOLING FAN THOR 80 BRIDE SUPPORT VENTILATEUR THOR 80	X						13,52 €
	928.205.012	BRIDA HELICE THOR 80 PROPELLER'S FLANGE THOR 80 PIPE HELICE THOR 80	X						45,06 €
	928.205.013	CENTRADOR HELICE THOR 80 PROPELLER NUT THOR 80 ECROU CENTRAGE HELICE THOR 80	X						11,50 €
	928.205.015	PIEZAS ENCENDIDO STARTER SPARE PARTS PIECES DEMARRAGE							9,57 €
	928.210.001	SEPARADORES MOTOR THOR 190/200/250 SPACER FOR THOR ENGINE 190/200/250 ENTRETOISE MOTEUR THOR 190/200/250			X	X	X		23,91 €
	928.210.002	SEPARADOR MOTOR THOR130 THOR130 ENGINE SPACERS ENTRETOISE MOTEUR THOR 130		X					17,23 €
	928.210.003	SEPARADOR MOTOR THOR80 THOR80 ENGINE SPACERS ENTRETOISE MOTEUR THOR 80	X						20,28 €
	928.210.004	SEPARADOR MOTOR THOR80 THOR80 ENGINE SPACERS ENTRETOISE MOTEUR THOR 80	X						16,90 €
	928.210.005	SEPARADOR ESTRIBO MOTOR THOR80 SPACER FOR BRACKER THOR 80 ENGINE ENTRETOISE ETRIER MOTEUR THOR 80	X						7,89 €
	928.215.001	ESPARRAGOS CILINDRO 7X135 CYLINDER STUDS 7X135 GOUJON FIXAGE CYLINDRE 7X135		X					11,95 €
	928.215.002	ESPARRAGOS MONTAJE ESCAPE 6X28 (Qty.2) THOR 100 MUFFLER FIXING STUDS 6X28 (Qty.2) THOR 100 MUFFLER FIXING STUDS 6X28 (Qty.2) THOR 100							7,19 €
	928.215.003	ESPARRAGOS MONTAJE CILINDRO 8X155 CYLINDER FIXING STUDS 8X155 GOUJON FIXAGE CYLINDRE 8X155			X	X	X		14,36 €
	928.215.004	ESPARRAGOS MONTAJE ESCAPE 8X37 MUFFLER FIXING STUDS 8X37 GOUJON FIXAGE POT 8X37			X	X	X		5,98 €
	928.215.005	ESPARRAGOS (CILINDRO-CULATA-CARTER) (4 Uds.) STUDS (CILINDER-HEAD CILINDER-CARTER) (4 Uds.) AXES (CYLINDRE-CULASSE-CARTER) (4 Uds.)	X						9,01 €
	928.220.001	RADIADOR DE AGUA THOR 250 LC WATER RADIATOR THOR 250 LC RADIATEUR EAU THOR 250 LC					X		329,88 €
	928.220.002	TAPA BOTELLA AGUA THOR 250LC WATER BOTTLE CAP THOR 250 LC BOUCHON BOUTEILLE EAU THOR 250	X				X		14,12 €
	928.220.004	RADIADOR DE AGUA THOR 80 WATER RADIATOR THOR 80 RADIATEUR EAU THOR 80	X						247,84 €
	928.225.001	TAPA SALIDA ACEITE OIL BREATHER PLUG BOUCHON DE VIDANGE HUILE	X	X	X	X	X		7,19 €

	928.225.003	UNION PARA CULATA THOR 250 LC WATER INLET THOR 250 LC RACCORD CULASSE THOR 250 LC					X	28,70 €
	928.225.004	UNION CULATA 90° THOR 250 LC 90° WATER INLET THOR 250 LC RACCORD CULASSE 90° THOR 250						20,93 €
	928.225.005	BRIDA PARA ENTRADA DE AGUA 90° THOR 250 DUAL S FLANGE FOR WATER CONNECTION 90° THOR 250 DUAL FLANGE FOR WATER CONNECTION 90° THOR 250 DUAL						29,02 €
	928.225.006	UNION VACIO AIRE PARA TUBO AGUA THOR 250 AIR INLET JOINT FOR WATER HOSE THOR 250 RACCORD VINDAGE AIR DURITE EAU THOR 250						30,42 €
	928.230.001	TUBO TRANSPARENTE 6X10 MT.5 TRANSPARENT PIPE 6X10 MT.5 ROULEAU TRANSPARENT 6X10 MT.5						44,83 €
	928.230.002	MANGUITO AGUA 16X23 MT.1 WATER HOSE 16X23 MT.1 DURITE EAU 16X23 MT.1					X	10,05 €
	928.230.003	MANGUITO 90 GRADOS BOMBA CILINDRO 90 DEGREE WATER HOSE FOR CYLINDER PUMP DURITE EAU 90 DEGREES POMPE CYLINDRE					X	7,19 €
	928.230.004	TUBO AGUA 6x9 MT.1 THOR 250 LC WATER HOSE 6x9 MT.1 DURITE EAU 6x9 MT.1					X	1,80 €
	928.230.005	TUBOS AGUA THOR 80 THOR80 WATER HOSES DURITES EAU THOR80	X					24,78 €
	928.235.001	ABRAZADERA PARA TUBO AGUA D.14 CLAMP FOR WATER HOSE D.14 COLLIER POUR DURITE EAU D.14	X				X	0,97 €
	928.235.002	ABRAZADERA PARA TUBO AGUA D.23 CLAMP FOR WATER HOSE D.23 COLLIER POUR DURITE EAU D.23					X	1,08 €
	928.235.003	ABRAZADERA PARA TUBO AGUA D.23,5 CLAMP FOR WATER HOSE D.23,5 COLLIER POUR DURITE EAU D.23,5					X	1,33 €
	928.235.004	ABRAZADERA BLOQUEO BOTELLA THOR 80 LOCKING CLAMP FOR THOR 80 BOTTLE COLLIER BLOQUAGE BOUTEILLE THOR 80	X					5,63 €
	928.235.005	ABRAZADERA PARA TUBO AGUA D.20 CLAMP FOR WATER HOSE D.20 COLLIER POUR DURITE EAU D.20	X					1,53 €
	928.235.006	ABRAZADERA PARA TUBO AGUA D.20,5 CLAMP FOR WATER HOSE D.20,5 COLLIER POUR DURITE EAU D.20,5	X					1,53 €
	928.235.007	ABRAZADERA PARA SILENCIOSO THOR 80/190 D.70 (2 piezas) SILENCER CLAMPS THOR 80/190 D.70 (2 pcs) COLLIER POUR SILENCIEUX THOR 80/190 D.70 (2 pieces)	X					24,78 €
	928.235.008	ABRAZADERA PARA TUBO AGUA D. 17 (5 POR 5 PIEZA) CLAMP FOR WATER HOSE F.17 (5 BY 5 PIECES) COLLIER POUR DURITE EAU D.17 (5 PAR 5 PIECES)						1,02 €
	928.245.001	TAPA CARBURADOR PWK PWK CARBURETOR BOWL CAP CAPOUCHON CUVE CARBURATEUR PWK		X		X	X	11,74 €
	928.246.001	TAPA BUJIA SPARK PLUG COVER PROTECTEUR BOUGIE		X	X	X		9,57 €
	928.246.002	TAPA CANALIZADOR AIRE AIR GRILL CAPS (qty 10) BOUCHON AIR CANALISEUR		X				4,68 €
	928.250.001	SOPORTES ANTIVIBRACION MOTOR (4 PC) ENGINE SILENT BLOCK (4 PCS) SILENT-BLOC FIXAGE MOTEUR		X				15,43 €



	928.271.001	CANALIZADOR AIRE DERECHO LADO ENCENDIDO AIR GRILL (RIGHT) IGNITION SIDE COUVERCLE VENTILATEUR AIR DROIT COTE ALLUM		X					41,25 €
	928.271.002	CANALIZADOR AIRE IZQUIERDO LADO HELICE AIR GRILL (LEFT) PROPELLER SIDE COUVERCLE VENTILATEUR AIR GAUCHE COTE HELICE		X					19,73 €
	928.271.003	CANALIZADOR AIRE DERECHO - LADO ENCENDIDO AIR GRILL (RIGHT) - IGNITION SIDE COUVERCLE VENTILATEUR AIRE DROIT - COTE ALLUMAGE					X		43,64 €
	928.271.004	CANALIZADOR AIRE IZQUIERDO - LADO HELICE AIR GRILL (LEFT) - PROPELLER SIDE COUVERCLE VENTILATEUR AIR GAUCHE - COTE HELICE					X		23,33 €
	928.271.005	TAPA VOLANTE THOR 250 LC FLYWHEEL COVER THOR 250 LC PROTECTEUR VOLANT THOR 250 LC						X	19,13 €
	928.271.006	CANALIZADOR AIRE DERECHO THOR 200 LADO ENCENDIDO AIR GRILL (RIGHT) THOR 200 IGNITION SIDE COUVERCLE VENTILATEUR AIRE DROIT COTE ALLUMAGE					X		43,64 €
	928.271.007	CANALIZADOR AIRE IZQUIERDO THOR 190 LADO HELICE AIR GRILL LEFT THOR 190 PROPELLER SIDE COUVERCLE VENTILATEUR AIR GAUCHE COTE HELICE					X		23,33 €
	928.271.008	CANALIZADOR AIRE THOR 80 AIR GRILL THOR 80 COUVERCLE VENTILATEUR AIRE THOR 80	X						39,38 €
	928.271.009	CANALIZADOR AIRE DERECH THOR 200 HF RIGHT AIR GRILL THOR 200 HF VENTILATEUR DROIT THOR 200 HF							49,57 €
	928.271.010	CANALIZADOR AIRE IZQUIERDO THOR 200 HF LEFT AIR GRILL THOR 200 HF VENTILATEUR GAUCHE THOR 200 HF							28,16 €
	928.271.011	CANALIZADOR AIRE DERECHO THOR 190 HF RIGHT AIR GRILL THOR 190 HF VENTILATEUR DROIT THOR 190 HF							49,57 €
	928.271.012	CANALIZADOR AIRE IZQUIERDO THOR 190 HF LEFT AIR GRILL THOR 190 HF VENTILATEUR GAUCHE THOR 190 HF							28,16 €
	928.275.002	COLECTOR DESCARGA ESCAPE (ROTULA ESCAPE) ALUMINIUM EXHAUST FLANGE BRIDE POT (ROTULE D'ECHAPPEMENT)		X					47,82 €
	928.275.003	COLECTOR DESCARGA ESCAPE EXHAUST FLANGE BRIDE POT				X	X	X	56,43 €
	928.275.004	COLECTOR DESCARGA ESCAPE THOR 80 EXHAUST FLANGE THOR 80 BRIDE POT THOR 80	X						60,83 €
	928.275.005	COLECTOR DESCARGA ESCAPE THOR 190 EXHAUST MANIFOLD FOR THOR 190 MUFFL PIPE ECHAPPEMENT POT THOR 190							60,83 €
	928.275.006	JUNTA COLECTOR DESCARGA ESCAPE THOR 80 OGIVE FOR EXHAUST PIPE THOR 80 OGIVE POUR PIPE ECHAPPEMENT THOR 80	X						5,63 €
	928.285.001	SILENCIOSO SILENCER SILENCIEUX		X					143,42 €
	928.285.002	SILENCIOSO SILENCER SILENCIEUX					X	X	167,09 €
	928.285.003	SILENCIOSO THOR 190 SILENCER THOR 190 SILENCIEUX THOR 190					X		157,82 €
	928.285.004	SILENCIOSO THOR 80 SILENCER THOR 80 SILENCIEUX THOR 80	X						123,92 €

	928.285.005	SILENCIOSO THOR 190 NEGRO SILENCER THOR 190 BLACK SILENCIEUX THOR 190 NOIR							135,19 €
	928.285.006	SILENCIOSO THOR 250 SILENCER THOR 250 SILENCER THOR 250							167,09 €
	928.285.007	SILENCIOSO THOR 130 SILENCER THOR 130 SILENCIEUX THOR 130		X					123,92 €
	928.285.008	SILENCIOSO THOR 80 LC D.70 NEGRO (D. 25 EXTERI SILENCER THOR 80 LC D.70 BLACK (EXTERNAL D. 25 SILENCIEUX THOR 80 LC D.70 NOIR (D.25 EXTERIEU							123,92 €
	928.305.001	TORNILLOS FIJACION ESCAPE SILENCER FIXING SCREWS VIS FIXAGE SILENCIEUX		X	X	X	X		8,15 €
	928.305.002	KIT TORNILLOS Y TUERCAS MOTOR ENGINE SCREWS AND NUTS SET KIT VIS ET ECROU MOTEUR		X					20,33 €
	928.305.003	TORNILLOS HELICE THOR 130 M.10X25 IZQUIERDA SCREW FOR PROPELLER THOR 130 M.10X25 (LEFT) VIS HELICE THOR 130 M.10X25 (GAUCHE)	X	X					6,97 €
	928.305.004	TORNILLOS PARA ESCAPE THOR 190 SCREW SET FOR THOR 190 MUFFLER VIS POUR POT THOR 190			X				10,45 €
	928.305.005	TORNILLO PARA POLEA THOR 190 IZQUIERDA SCREW FOR THOR 190 PULLEY LEFT VIS POULIE THOR 190 GAUCHE			X				6,40 €
	928.305.006	TORNILLO MOTOR THOR 190 M.8X80 (2 PIEZAS) SCREW FOR THOR 190 ENGINE M.8X80 (2 PIECES) VIS MOTEUR THOR 190 M.8X80 (2 PIECES)			X				5,23 €
	928.305.007	TORNILLO MOTOR THOR 190 M.8X80 (2 PIEZAS) SCREW FOR THOR 190 ENGINE M.8X80 (2 PIECES) VIS MOTEUR THOR 190 M.8X80 (2 PIECES)			X				3,96 €
	928.305.008	TORNILLO PARA HELICE THOR 190 M.8X35 (6 PIEZAS) SCREW FOR PROPELLER THOR 190 M.8X35 (6 PIECES) VIS HELICE THOR 190 M.8X35 (6 PIECES)			X				4,54 €
	928.305.009	KIT TORNILLOS MOTOR ENGINE SCREWS SET KIT VIS MOTEUR				X			17,41 €
	928.305.010	TORNILLOS CARTER MOTOR THOR 190 CRANK CASE SCREWS THOR 190 VIS CARTER MOTEUR THOR 190							13,93 €
	928.305.011	TORNILLOS CARTER MOTOR THOR 80 CRANK CASE SCREWS THOR 80 VIS CARTER MOTEUR THOR 80							9,01 €
	928.310.001	TUERCA EMBRAGUE CON MUELLE CLUTCH NUT WITH SPRING ECROU ET RESSORT D' EMBRAYAGE		X					6,23 €
	928.310.002	TUERCA VOLANTE D.10X1,25 FLYWHEEL NUT ECROU VOLANT	X		X				0,72 €
	928.310.003	TUERCAS FIJACION CULATA FIXING NUTS FOR CYLINDER HEAD ECROU FIXATION CULASSE		X					3,48 €
	928.310.004	TUERCA VOLANTE D.12X1,25 FLYWHEEL NUT D.12X1,25 ECROU FIXATION VOLANT D.12X1,25		X		X	X		2,65 €
	928.310.005	TUERCA EMBRAGUE CLUTCH NUT ECROU D'EMBRAYAGE			X	X	X		7,67 €
	928.310.006	TUERCA ENGRAN. ARBOL EQUIL. THOR200 GEAR NUT FOR BALANC.SHAFT THOR200 ECROU ENGREN. ARBRE DE BALANCEMENT				X	X		1,44 €

	928.310.007	TUERCAS FIJACION CULATA HEAD FIXING NUTS ECROUS FIXATION CULASSE			X	X			7,19 €
	928.310.008	TUERCAS FIJACION CULATA THOR 250 LC HEAD FIXING NUTS THOR 250 LC ECROUS FIXATION CULASSE THOR 250 LC					X		2,41 €
	928.310.009	CENTRADORES HELICE THOR 250 LC DERECHO PROPELLER NUT THOR 250 LC RIGHT ECROU CENTRAGE HELICE THOR 250 LC DROIT				X	X		14,95 €
	928.310.010	CENTRADOR HELICE THOR 200/250 IZQUIERDOS PROPELLER NUT THOR 200/250 LEFT ECROU CENTRAGE HELICE THOR 200/250 GAUCHE				X	X		15,09 €
	928.310.011	TUERCAS FIJACION PLACA POLEA THOR 190 FIXING NUTS FOR PULLEY'S PLATE THOR 190 ECROUS FIXATION PLAQUE POULIE THOR 190			X				12,76 €
	928.310.012	TUERCA POLEA MOTRIZ THOR 190 DRIVE PULLEY NUT THOR 190 ECROU POULIE D'ENTRAINEMENT THOR 190							1,17 €
	928.310.013	TUERCA ENGRANAJE PRIMARIO THOR 80 PRIMARY GEAR NUT THOR 80 ECROU ENGRENAGE PRIMAIRE THOR 80	X						3,95 €
	928.310.014	TUERCAS Y TORNILLOS CULATA THOR 80 NUTS AND SCREWS FOR THOR 80 HEAD SERIE ECROUS ET VIS CULASSE THOR 80	X						10,14 €
	928.310.015	TUERCA EMBRAGUE THOR 80 CLUTCH NUT THOR 80 ECROU D'EMBRAYAGE THOR 80	X						2,82 €
	928.322.001	ARANDELA DE FIBRA 6,5X22X1,8 (8 PIEZAS) FIBER WASHER 6,5X22X1,8 (8 PIECES) RONDELLE EN FIBRE 6,5X22X1,8 (8 PIECES)			X				7,56 €
	928.330.001	BOTELLA DE CARGA AGUA THOR 250 LC WATER EXPANSION BOTTLE THOR 250 LC VASE EXPANSION EAU THOR 250 LC					X		93,24 €
	928.330.002	BOTELLA DE CARGA AGUA THOR 80 WATER EXPANSION BOTTLE THOR 80 VASE EXPANSION EAU THOR 80	X						65,34 €
	928.335.001	REDUCCION CARBURADOR WALBRO WALBRO CARBURETOR REDUCTION REDUCTION CARBURATEUR WALBRO		X	X	X			15,55 €
	928.335.002	REDUCCION CARBURADOR WALBRO THOR80 THOR80 WALBRO CARBURETOR REDUCTION REDUCTION CARBURATEUR WALBRO THOR80	X						15,55 €
	928.340.001	ESTRIBO DE SOPORTE BOBINA ENGINE COIL BRACKET PATTE SUPPORT BOBINE		X					20,93 €
	928.340.002	ESTRIBO DE SOPORTE BOMBA CARBURANTE FUEL PUMP BRACKET PATTE SUPPORT POMPE ESSENCE		X					8,38 €
	928.340.003	ESTRIBO DE SOPORTE BOBINA ENGINE COIL BRACKET PATTE SUPPORT BOBINE				X	X		22,97 €
	928.340.004	ESTRIBO BOMBA CARBURANTE FUEL PUMP BRACKET PATTE SUPPORT POMPE ESSENCE				X	X		8,98 €
	928.340.005	ESTRIBO CABLE ACCELERADOR THOR 200 GAS CABLE BRACKET THOR 200 PATTE CABLE ACCELERATEUR THOR 200				X			9,57 €
	928.340.006	ESTRIBO DE SOPORTE RELE THOR 200 RELAIS BRACKET THOR 200 RELAIS BRACKET THOR 200							9,57 €
	928.340.007	ESTRIBOS RADIADOR THOR 250 LC RADIATOR BRACKETS THOR 250 LC PATTE SUPPORT RADIATEUR THOR 250 LC					X		32,67 €

	928.340.008	ESTRIBO SOP. MOTOR ARRANQUE THOR 250 IGNITION ENGINE BRACKET THOR 250 ETRIERS SUPPORT MOTEUR DEMARRAGE TH 250							35,86 €	
	928.340.009	ESTRIBO SOPORTE HILO GAS THOR 190 GAS CABLE SUPPORT LEVER THOR 190 ETRIER SUPPORT CABLE GAS THOR 190							10,14 €	
	928.340.010	ESTRIBO SOPORTE RADIADOR THOR 80 (2 PIEZAS) RADIATOR SUPPORT LEVER THOR 80 (2 PIECES) ETRIER SUPPOR RADIATEUR THOR 80 (2 PIECES)							13,52 €	
	928.350.002	CORREA 15 GRABADOS THOR 190 15-ENGRAVING BELT THOR 190 COURROIE 15 CRAIDRES THOR 190				X			44,10 €	
	928.355.001	JUEGO OR PARA COLECTOR ESCAPE OR SET FOR EXHAUST MANFOLD SERIE OR COLLECTEUR POT							2,41 €	
	928.355.002	SERIE OR COLECTOR DESCARGA ALU. ALUM. OR SET FOR EXHAUST MANIFOLD SERIE OR COLLECTEUR POT ALUMINIUM							2,41 €	
	928.355.003	OR PARA TAPA SALIDA GASOLINA OR FOR FUEL BREATHER PLUG OR POUR BOUCHON DE VIDANGE ESSENCE	X	X			X	X	0,97 €	
	928.355.004	OR PARA TAPA SALIDA GASOLINA PWK OR FOR FUEL BREATHER PLUS PWK OR BOUCHON DE VINDAGE ESSENCE PWK	X	X			X	X	0,61 €	
	928.360.002	SOPORTE MOTOR ENGINE SUPPORT SUPPORT MOTEUR					X	X	70,53 €	
	928.360.003	KIT SOPORTE CULATA MOTOR HEAD SUPPORT KIT ENGINE KIT SUPPORT CULASSE MOTEUR					X	X	58,82 €	
	928.360.004	SOPORTE MOTOR THOR 130 THOR 130 ENGINE SUPPORT SUPPORT MOTEUR THOR 130				X			69,33 €	
	928.360.005	KIT SOPORTE CULATA MOTOR THOR 130 HEAD SUPPORT KIT THOR130 ENGINE KIT SUPPORT CULASSE MOTEUR THOR130				X			58,82 €	
	928.360.006	SOPORTE MOTOR THOR 190 ENGINE SUPPORT THOR 190 SUPPORT MOTEUR THOR 190					X		68,47 €	
	928.360.007	SOPORTE MOTOR THOR 190 A.E. ENGINE SUPPORT THOR 190 E.S. SUPPORT MOTEUR THOR 190 A.E.							69,63 €	
	928.360.008	KIT SOPORTE CULATA MOTOR THOR 190 HEAD SUPPORT THOR 190 ENGINE SUPPORT CULASSE MOTEUR THOR 190					X		50,14 €	
	928.360.009	SOPORTE MOTOR THOR 80 ENGINE SUPPORT THOR 80 SUPPORT MOTEUR THOR 80	X						73,23 €	
	928.360.010	ESTRIBO DE SOPORTE MOTOR THOR 80 ENGINE SUPPORT BRACKET THOR 80 ETRIER SUPPORT MOTEUR THOR 80	X						14,65 €	
	928.360.011	SOPORTE BOTELLA DE AGUA THOR 80 WATER BOTTLE SUPPORT LEVER THOR 80 ETRIER SUPPORT BOUTEILLE EAU THOR 80	X						22,53 €	
	928.360.012	ESTRIBO DE SOPORTE MOTOR THOR 130/200/250 ENGINE SUPPORT BRACKET THOR 130/200/250 ETRIER SUPPORT MOTEUR THOR 130/200/250							5,63 €	
	928.375.002	GOMA ANTIVIBRACION ESCAPE ANTIVIBRATION MUFFLER RUBBER RONDELLE ANTIVIBRATION POT					X	X	X	7,79 €
	928.375.003	GOMA ANTIVIBRACION ESCAPE THOR 190 MUFFLER ANTIVIB. RUBBERS THOR 190 ENGINE RONDELLE ANTIVIBRATION POT THOR 190					X		6,74 €	

			80	130	190	200	250	PVP
	928.375.004	GOMAS SOPORTE MOTOR PUJANTE THOR 80/190 (4) RUBBER FOR TRACTOR ENGINE THOR 80/190 (4) CAOUTCHOUC SUPPORT POT THOR 80/190 (4)						77,73 €
	928.375.005	GOMAS DE SOPORTE ESCAPE (4) RUBBERS FOR MUFFLER (4) CAOUTCHOUC SUPPORT POT (4)	X	X		X	X	15,77 €
	928.400.002	LÁMINAS (2 PIEZAS) REED VALVE SHEETS (2 PIECES) CLAPETS (2 PIECES)					X	28,16 €
	928.400.003	LAMINAS PARA VALVULA LAMINAR MOTOR THOR 130/190 REEDS FOR REED VALVE ENGINE THOR 130/190/200 CLAPETS POUR BOITE A CLAPETS THOR 130/190/200						25,91 €
	928.405.001	CAJA DE LÁMINAS REED VALVE BOÎTE À CLAPPETS		X	X			78,41 €
	928.405.002	CAJA DE LÁMINAS THOR 250 REED VALVE THOR 250 BOÎTE À CLAPPETS THOR 250					X	82,48 €
	928.405.003	CAJA DE LÁMINAS THOR 200 REED VALVE THOR 200 BOÎTE À CLAPPETS THOR 200				X		109,08 €
	928.405.004	CAJA DE LÁMINAS THOR 80 REED VALVE THOR 80 BOÎTE À CLAPPETS THOR 80	X					54,08 €
	928.415.001	PLANCHA POLEA THOR 190 PULLEY PLATE THOR 190 PLAQUE POULIE THOR 190			X			90,52 €
	928.420.001	ESTRIBO DE REGULACION CORREA THOR 190 BELT ADJUSTING LEVER THOR 190 LEVIER REGLAGE COURROIE THOR 190			X			7,56 €
	928.425.002	ESCAPE (SIN SILENCIOSO) CON ROTULA MUFFLER WITHOUT SILENC.WITH MANIFOLD POT D'ÉCHAPPEMENT SANS SILENCIEUX AVEC BRIDE		X				305,98 €
	928.425.003	ESCAPE SIN SILENCIOSO MUFFLER WITHOUT SILENCER POT SANS SILENCIEUX				X	X	348,10 €
	928.425.007	ESCAPE THOR 190 BLOQUEO ELASTICO NAKED MUFFLER THOR 190 ELASTIC FIXING POT NU THOR 190 FIXATION ELASTIQUE						416,83 €
	928.425.009	ESCAPE SIN SILENCIOSO THOR 190 MUFFLER WITHOUT SILENCER THOR 190 POT SANS SILENCIEUX THOR 190			X			416,83 €
	928.425.010	ESCAPE SIN SILENCIOSO THOR 130 MUFFLER WITHOUT SILENCER THOR 130 POT SANS SILENCIEUX THOR 130		X				405,56 €
	928.425.011	ESCAPE COMPLETO DE TITANIUM THOR 190/200 COMPLETE TITANIUM MUFFLER THOR 190/200 POT COMPLET EN TITANIUM THOR 190/200						1.033,59 €
	928.425.012	ESCAPE COMPLETO DE TITANIUM THOR 250 COMPLETE TITANIUM MUFFLER THOR 250 POT COMPLET EN TITANIUM THOR 250						1.033,59 €
	928.426.001	PLACA RESORTE ESCAPE THOR 200 MUFFLER SPRING PLATE THOR 200 PLAQUE RESSORT POT THOR 200			X	X	X	8,26 €
	928.426.002	PLANCHA PARA RESORTES ESCAPE THOR 130 SPRING PLATE FOR THOR 130 MUFFLER PLAQUE RESSORTS POT THOR 130		X				8,26 €
	928.426.003	BLOQUEADORES ESCAPE DEL. THOR 80/190 FIXING PINS FOR FRONT MUFFLER THOR 80/190 PLOTS FIXATION POT AVANT THOR 80/190	X		X			10,14 €
	928.426.004	BLOQUEADORES ESCAPE TRASERO THOR 80 FIXING PINS REAR MUFFLER THOR 80 PLOTS DE FIXATION POT ARRIERE THOR 80	X					9,01 €

			80	130	190	200	250	PVP
	928.426.005	PLACA RESORTE ESCAPE THOR 80 SPRING PLATE FOR THOR 80 MUFFLER PLAQUE RESSORTS POT THOR 80	X	X				8,35 €
	928.426.006	BLOQUEDORES ESCAPE TRASERO THOR 200/250 FIXING PINS FOR REAR MUFFLER THOR 200/250 PLOTS FIXATION POT ARRIERE THOR 200/250						9,01 €
	928.426.007	BLOQUEDORES ESCAPE THOR 130 EVO FIXING PINS FOR MUFFLER THOR 130 EVO PLOTS FIXATION POT THOR 130 EVO						13,52 €
	928.430.001	MANGUITO CARBURADOR CAJA FILTRO AIR BOX CARBURETOR COUPLING MANCHON CARBURATEUR BOITIER FILTRE		X	X	X	X	13,16 €
	928.440.001	CARBURADOR WALBRO WG8 CARBURETOR WALBRO WG8 CARBURATEUR WALBRO WG8		X				230,68 €
	928.440.002	KIT MEMBRANAS CARBURADOR WALBRO WG8 CARBURETOR DIAPHRAGM SET WALBRO WG8 KIT MEMBRANE WALBRO WG8		X				15,31 €
	928.440.004	MUELLE BALANCIN CARBURADOR WALBRO FLY PRESS SPRING FOR WALBRO CARB. RESSORT DE FOURCHETTE CARBURATEUR WALBRO		X				2,17 €
	928.440.006	BOMBA CARBURANTE (MIKUNI) PARA CARBURADOR FUEL PUMP (MIKUNI) FOR CARBURETOR POMPE ESSENCE (MIKUNI) POUR CARBURATEUR		X		X	X	60,83 €
	928.440.007	CARBURADOR D.24 THOR 100/130 CARBURETOR D.24 THOR 100/130 CARBURATEUR D.24 THOR 100/130		X				105,19 €
	928.440.008	KIT REPARACION CARBURADOR WALBRO WG8 WALBRO WG8 CARBURETTOR REPAIR KIT KIT REPARATION CARBURATEUR WALBRO WG8		X				21,53 €
	928.440.009	CARBURADOR THOR 200 D. 28 CARBURETTOR THOR 200 D.28 CARBURATEUR THOR 200 D.28				X		112,36 €
	928.440.010	CARBURADOR WALBRO WB37 CARBURETTOR WALBRO WB37 CARBURATEUR WALBRO WB37				X		211,44 €
	928.440.011	KIT REPARACION CARBURADOR WALBRO WB37 WALBRO WB37 CARBURETTOR REPAIR KIT KIT REPARATION WALBRO WB37 CARBURATEUR			X	X		23,33 €
	928.440.012	CARBURADOR D.28 THOR 250 CARBURETOR D.28 THOR 250 CARBURATEUR D.28 THOR 250					X	112,36 €
	928.440.013	CARBURADOR WALBRO WB37 CARBURETTOR WALBRO WB37 CARBURATEUR WALBRO WB37			X			211,44 €
	928.440.014	CARBURADOR WALBRO WG8 THOR 80 LC CARBURETOR WALBRO WG8 THOR 80 LC CARBURATEUR WALBRO WG8 THOR 80 LC						230,68 €
	928.440.015	CARBURADOR CP D.21 THOR 80 LC CARBURETOR CP D.21 THOR 80 LC CARBURATEUR CP D.21 THOR 80 LC	X					101,39 €
	928.440.016	BOMBA DE GASOLINA PARA CARBURADOR THOR 80 FUEL PUMP FOR CARBURETOR THOR 80 POMPE A ESSENCE POUR CARBURATERUR THOR 80	X					28,16 €
	928.440.017	KIT BOMBA DE GASOLINA THOR 80 KIT FOR FUEL PUMP THOR 80 KIT POUR POMPE A ESSENCE THOR 80	X					12,39 €
	928.440.018	CARBURADOR D.28 THOR 200 MOTOR HF CARBURETOR D.28 THOR 200 HF ENGINE CARBURATEUR D.28 THOR 200 MOTEUR HF						112,36 €
	928.445.001	CHICLE DE ALTA 130 CARB.WALBRO WG8 MAIN JET 130 CARB.WALBRO WG8 GICLEUR 130 CARB.WALBRO WG8		X				5,39 €



	928.445.002	CHICLE DE ALTA 140 CARB.WALBRO WG8 MAIN JET 140 CARB.WALBRO WG8 GICLEUR 140 CARB.WALBRO WG8		X					5,39 €
	928.445.003	CHICLE DE ALTA 125 CARB.WALBRO WG8 CHICLE DE ALTA 125 CARB.WALBRO WG8 GICLEUR MAXIMUM 125 CARB.WALBRO WG8							5,39 €
	928.445.004	CHICLE DE ALTA 070 CARBURADOR WALBRO WG8 MAIN JET 070 WALBRO WG8 CARBURETOR GICLEUR MAXIMUM 070 CARBURATEUR WALBRO WG8							5,39 €
	928.465.001	SILENCIADOR DE ADMISION (AIRBOX) AIR FILTER BOX AIRBOX		X					98,01 €
	928.465.002	CAJA FILTRO DE AIRE THOR 130/250 AIR FILTER CARBURETOR THOR 130/250 FILTRE A AIR CARBURATEUR THOR 130/250							98,01 €
	928.465.003	CAJA FILTRO DE AIRE D.28 AIR FILTER CASE D.28 BOITE FILTRE A AIR D.28			X	X	X		98,01 €
	928.465.011	CAJA FILTRO DE AIRE THOR 80 AIR FILTER CASE THOR 80 BOITE FILTRE A AIR THOR 80	X						31,54 €
	928.465.012	CAJA FILTRO DE AIRE THOR 190/200 WALBRO HF AIR FILTER BOX THOR 190/200 WALBRO HF FILTRE A AIR THOR 190/200 WALBRO HF							98,01 €
	928.465.013	CAJA FILTRO DE AIRE THOR 200 HF CARB.28 AIR BOX THOR 200 HF CARB.28 BOITE FILTRE A AIR THOR 200 HF CARB.28							98,01 €
	928.465.014	CAJA FILTRO DE AIRE THOR CARBURADOR PWK GIRADO TURNED AIR FILTER BOX THOR PWK CARBURETOR FILTRE A AIR THOR CARBURATEUR PWK TOURNE							39,43 €
	928.470.001	FILTRO DE AIRE AIR FILTER FILTRE A AIR		X	X	X	X		6,95 €
	928.470.002	FILTRO DE AIRE THOR 80 AIR FILTER THOR 80 FILTRE A AIR THOR 80							6,76 €
	928.550.002	POLEA CONDUCIDA THOR 190 DRIVEN PULLEY THOR 190 POULIE ENTRAINEE THOR 190			X				113,72 €
	928.550.003	POLEA DE ACCIONAMIENTO THOR 190 DRIVE PULLEY THOR 190 DRIVE PULLEY THOR 190							33,65 €
	928.550.004	POLEA DE ACCIONAMIENTO CON CAMPANA THOR 190 DRIVE PULLEY W/BELL THOR 190 POULIE D'ENTRAINEMENT AVEC CLOCHE THOR 190			X				103,28 €
	928.555.001	VOLANTE COMPLETO COMPLETE FLYWHEEL VOLANT COMPLET							157,77 €
	928.555.002	VOLANTE COMPLETO D.12 COMPLETE FLYWHEEL D.12 VOLANT COMPLET D.12		X		X	X		180,25 €
	928.555.003	VOLANTE CON CORONA ENCENDIDO FLYWHEEL WITH IGN. SPROCKET VOLANT COMPLET AVEC COURONNE ALL.							236,58 €
	928.555.004	VOLANTE THOR 190/190 EMBRAGUE FLYWHEEL THOR 190/190 CLUTCH VOLANT THOR 190/190 EMBRAYAGE		X					91,68 €
	928.585.001	CHAVETA DE DISCO EMBRAGUE CLUTCH KEY WAY CLAVETTE D' EMBRAYAGE		X					0,50 €
	928.585.002	CHAVETA DE DISCO VOLANTE FLYWHEEL KEY WAY LANGUETTE DISQUE VOLANT		X		X	X		0,62 €

	928.585.003	CHAVETA DE DISCO EMBRAGUE CLUTCH KEY WAY LANGUETTE DISQUE EMB928.600.007				X	X	0,97 €
	928.585.004	CHAVETA DE DISCO ARBOL DE EQUILIBRIO BALANCING SHAFT KEY WAY LANGUETTE DISQUE ARBRE DE BALANCEMENT				X	X	0,97 €
	928.600.001	BOBINA COIL BOBINE		X		X	X	52,39 €
	928.600.003	ENGRANAJE ARRANQUE THOR 200 STARTER BITE GEAR THOR 200 ENGRENAGE EMBRAY. ALLUMAGE THOR 200						117,13 €
	928.600.004	MOTOR ARRANQUE THOR 200 ELECTRIC STARTER THOR 190/200 MOTEUR ALLUMAGE THOR 200						143,42 €
	928.600.005	CDI THOR 250 LC DUAL SPARK CDI THOR 250 LC DUAL SPARK CDI THOR 250 LC DUAL SPARK						110,40 €
	928.600.006	BUJIA NGK BR10ES SPARK PLUG NGK BR10ES BOUGIE NGK BR10ES		X		X		6,23 €
	928.600.007	MOTOR ARRANQUE THOR 250 ELECTRIC STARTER THOR 250 MOTEUR DEMARRAGE THOR 250						167,33 €
	928.600.006SS	BUJIA NGK BR10ES SIN JUNTA SPARK PLUG NGK BR10ES WITHOUT GASKET BOUGIE NGK BR10ES SANS JOINT		X		X		4,00 €
	928.600.008	BOBINA THOR 80 COIL THOR 80 BOBINE THOR 80	X		X			60,34 €
	928.600.009	BUJIA NGK B9ES SPARK PLUG NGK B9ES BOUGIE NGK B9ES				X		5,81 €
	928.600.009SS	BUJIA NGK BR9ES SIN JUNTA SPARK PLUG NGK BR9ES WITHOUT GASKET BOUGIE NGK BR9ES SANS JOINT				X		4,00 €
	928.600.010	BOBINA THOR190 COIL THOR190 BOBINE THOR190				X		72,10 €
	928.600.011	ENCENDIDO STATOR ALLUMAGE		X		X	X	95,76 €
	928.605.001	CENTRADORES (6 PZ) HEAD PINS (Q.TY 6) CENTREUSER (6 PC)		X	X	X	X	3,60 €
	928.666.001	VENTILADOR REFRIGERACION COOLING FAN VENTILATEUR DE RÉFRIGÉRATION		X				14,95 €
	928.666.002	VENTILADOR REFRIGERACION COOLING FAN VENTILATEUR POUR REFRROIDIR			X	X		14,95 €
	928.666.003	VENTILADOR REFRIGERACION THOR 80 COOLING FAN THOR 80 VENTILATEUR POUR REFRROIDIR THOR 80	X					18,03 €
	928.680.002	CUERDA ARRANQUE COMPLETE COMPLETE START ROPE CORDE DÉMARREUR	X	X	X	X	X	13,52 €
	928.705.001	TORNILLOS/MUELLES EMBRAGUE CLUTCH SCREWS AND SPRINGS VIS ET RESSORTS EMBRAYAGE				X	X	22,72 €
	928.765.008	ACELERADOR THOR 200/250 CARB.PWK CON INTERRUPTOR THROTTLE THOR 200/250 CARB.PWK W/SWITHC ON/OFF ACCELERATEUR THOR THOR 200/250 CARB.PWK AVEC ALL/COUP				X	X	117,13 €



PAP

POLINI











80 130 190 200 250 PVP

	928.802.003	DEPOSITO DESAGUE DE GASOLINA FUEL OVERFLOW TANK RESERVOIR TROP PLEIN ESSENCE	X	X		X	X	9,57 €
	928.830.001	REGULADOR TENSION VOLTAGE REGULATOR REGULATEUR DE TENSION		X		X	X	54,08 €
	928.830.004	CHT DE BUJIA SPARK PLUG CHT THERMOCOUPLE BOUGIE						50,20 €
	928.830.005	BATERIA 12V THOR 190/200/250 (MBTX4U) 12V BATTERY THOR 190/200/250 (MBTX4U) BATTERIE 12V THOR 190/200/250 (MBTX4U)						66,95 €
	928.830.012	SENSOR DE TEMPERATURA DE AGUA LC M.8 WATER TEMPERATURE SENSOR LC M.8 SENSEUR TEMPERATURE EAU LC M.8	X				X	52,95 €
	CHAMPION N2C / NGK BR9ES	BUJIA CHAMPION RN2C / NGK BR9ES SPARK PLUG CHAMPION RN2C / NGK BR9ES BOUGIE CHAMPION RN2C / NGK BR9ES	X				X	5,00 €





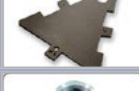

FUERA DE LOS DESPIECES · OUT OF EXPLODED VIEWS · HORS VUES ÉCLATÉES

	144.230.003	MANGUERA DEL RADIADOR RADIATOR HOSE TUYAU DU RADIATEUR					X	8,19 €
	928.015.006	KIT MODIFICACION CULATA AIRE THOR 200 (KIT EVO) A/C HEAD MODIFICATION KIT THOR 200 (KIT EVO) MODIFICATION CULASSE AIR THOR 200 (KIT EVO)					X	105,19 €
	928.830.002	TACOMETRO/ORAS DIGITAL + SENSOR CHT DIGITAL RPM-HOURMETER + CHT SENSOR COMPTE-TOURS DIGITAL AVEC THERMOCOUPLE BOUGIE ET COMPTE		X	X	X	X	197,21 €
	928.830.009	TERMOSTATO DE AGUA WATER THERMOSTAT THERMOSTAT D'EAU					X	44,10 €
	KWb-Pw- TH200	KIT CONVERSION WALBRO A PWK (223.0102 / 928.440.009 / 928.270.003 / 928.440.006 / 928.340.004 / 928.802.003) WALBRO TO PWK CONVERSION KIT (223.0102 / 928.440.009 / 928.270.003 / 928.440.006 / 928.340.004 / 928.802.003) KIT CONVERSION WALBRO A PWK (223.0102 / 928.440.009 / 928.270.003 / 928.440.006 / 928.340.004 / 928.802.003)					X	256,25 €
	KP928.340.007	KIT FIJACION PAP RADIADOR TH250 (144.230.002) RADIATOR THOR 250 PAP FIXING KIT (144.230.002) KIT FIXATION PAP RADIATEUR THOR 250 (144.230.002)					X	93,75 €
	JP928.830.009	JUNTAS PAP PARA TERMOSTATO DE AGUA (ANTES FEBRERO 2016) PAP WATER THERMOSTAT JOINTS (BEFORE FEBRUARY 2016) JOINTS PAP THERMOSTAT D'EAU (AVANT 2016 FÉVRIER)					X	6,25 €



















HERRAMIENTAS POLINI · POLINI TOOLS · OUTILS POLINI

	143.695.001	EXTRACTOR VOLANTE M22X1,5 TOOL FLYWHEEL PULLER M22X1,5 EXTRACTEUR VOLANT M22X1,5		X	X	X	X	11,05 €
	144.695.004	EXTRACTOR GRUPO EMBRAGUE 3G TOOL 3G CLUTCH PULLER EXTRACTEUR EMBRAYAGE 3G		X				19,87 €
	144.695.005	LLAVE AJUSTE MUELLE EMBRAGUE 3G CLUTCH SPRING ADJUSTING KEY 3G CLÉ RÉGLAGE RESSORT EMBRAYAGE 3G		X				4,65 €
	144.695.006	LLAVE DE BLOQUEO PARA EMBRAGUE 3G BLOCK KEY FOR CLUTCH 3G CLÉ POUR FERMER L'EMBRAYAGE 3G		X				45,80 €
	173.0002	CONJUNTO PARA CONTROLAR EL AVANCE DEL ENCENDIDO CHECKING TOOL FOR IGNITION ADVANCE OUTIL CONTROLE AVANCE ALLUMAGE			X			56,88 €
	928.695.001	EXTRACTOR PARA DESMONTAR CARTER CRANKCASE TOOL PULLER EXTRACTEUR OUVERTURE CARTER MOTEUR		X	X	X	X	26,30 €
	928.695.003	CASQUILLO MONTAJE RETÉN OILSEAL FITTING BUSH COQUILLE ASSEMBLAGE JOINT SPY		X				7,55 €
	928.695.004	SOPORTE MOTOR TALLER ENGINE SUPPORT FOR WORKSHOP SUPPORT MOTEUR POUR USINE		X	X	X	X	54,55 €
	928.695.005	CALIBRE DE CONTROL DEL CARB. WALBRO MEASURES THE CONTROL OF CARB. WALBRO MEASURES THE CONTROL OF CARB. WALBRO		X	X	X	X	8,95 €
	928.695.007	BUJE PARA MONTAR RETEN THOR OIL SEAL FITTING BUSHING THOR BAGUE MONTAGE JOINT SPY THOR		X	X	X		7,55 €

CARBURADOR PWK Ø28 · PWK Ø28 CARBURATOR · CARBURATEUR PWK Ø28

	050.0034	JUNTA PAPEL (342.0106) PAPER GASKET (342.0106) JOINT (342.0106)				X	X	4,00 €
	342.0101	OR CARBURADOR PWK OR FOR PWK CARBURETOR JOINTS CUVE CARBURATEUR PWK				X	X	3,37 €
	342.0102	FLOTADOR PARA CARBURADOR PWK FLOAT FOR PWK CARBURETOR FLOTTEUR POUR CARBURATEUR PWK				X	X	10,12 €
	342.0108	MUELLE VALVULA CARB. PWK VALVE SPRING PWK CARBURETOR RESSORT RAPPEL SOUPEPE CARB. PWK				X	X	3,37 €
	342.0119	AGUJA CONICA PARA CARB. PWK 28 CONICAL NEEDLE FOR PWK CARB. 28 POINTEAU CONIQUE POUR CARB. PWK 28				X	X	7,95 €
	343.0017	AGUJA CIERRE GASOLINA CARB. CP-PWK FUEL LOCKING NEEDLE PWK-CARB. POINTEAU FERMETURE ESSENCE CARB. CP-PWK				X	X	3,78 €

CARBURADOR PWK Ø28 · PWK Ø28 CARBURATOR · CARBURATEUR PWK Ø28

	370.1118	CHICLE DE ALTA KEIHIN/PWK 118 MAIN JET 118 KEIHIN/PWK GICLEUR HAUT 118 KEIHIN/PWK					X	X	4,80 €
	370.1120	CHICLE DE ALTA KEIHIN/PWK 120 MAIN JET 120 KEIHIN/PWK GICLEUR HAUT 120 KEIHIN/PWK					X	X	4,80 €
	370.1126	CHICLE DE ALTA KEIHIN/PWK 126 MAIN JET 126 KEIHIN/PWK GICLEUR HAUT 126 KEIHIN/PWK					X	X	4,80 €
	370.1128	CHICLE DE ALTA KEIHIN/PWK 128 MAIN JET 128 KEIHIN/PWK GICLEUR HAUT 128 KEIHIN/PWK					X	X	4,80 €
	370.1130	CHICLE DE ALTA KEIHIN/PWK 130 MAIN JET 130 KEIHIN/PWK GICLEUR HAUT 130 KEIHIN/PWK					X	X	4,80 €
	370.1136	CHICLE DE ALTA KEIHIN/PWK 136 MAIN JET 136 KEIHIN/PWK GICLEUR HAUT 136 KEIHIN/PWK					X	X	4,80 €
	370.1138	CHICLE DE ALTA KEIHIN/PWK 138 MAIN JET 138 KEIHIN/PWK GICLEUR HAUT 138 KEIHIN/PWK					X	X	4,80 €
	370.1140	CHICLE DE ALTA KEIHIN/PWK 140 MAIN JET 140 KEIHIN/PWK GICLEUR HAUT 140 KEIHIN/PWK					X	X	4,80 €
	370.1142	CHICLE DE ALTA KEIHIN/PWK 142 MAIN JET 142 KEIHIN/PWK GICLEUR HAUT 142 KEIHIN/PWK					X	X	4,80 €
	370.1144	CHICLE DE ALTA KEIHIN/PWK 144 MAIN JET 144 KEIHIN/PWK GICLEUR HAUT 144 KEIHIN/PWK					X	X	4,80 €
	370.1146	CHICLE DE ALTA KEIHIN/PWK 146 MAIN JET 146 KEIHIN/PWK GICLEUR HAUT 146 KEIHIN/PWK					X	X	4,80 €
	370.1148	CHICLE DE ALTA KEIHIN/PWK 148 MAIN JET 148 KEIHIN/PWK GICLEUR HAUT 148 KEIHIN/PWK					X	X	4,80 €
	372.1035	CHICLE MIN. KEIHIN/PWK 35 LOW JET 35 KEIHIN/PWK GICLEUR BASE 35 KEIHIN/PWK					X	X	3,80 €
	372.1038	CHICLE MIN. KEIHIN/PWK 38 LOW JET 38 KEIHIN/PWK GICLEUR BASE 38 KEIHIN/PWK					X	X	3,80 €
	372.1040	CHICLE MIN. KEIHIN/PWK 40 LOW JET 40 KEIHIN/PWK GICLEUR BASE 40 KEIHIN/PWK					X	X	3,80 €
	372.1042	CHICLE MIN. KEIHIN/PWK 42 LOW JET 42 KEIHIN/PWK GICLEUR BASE 42 KEIHIN/PWK					X	X	3,80 €
	372.1045	CHICLE MIN. KEIHIN/PWK 45 LOW JET 45 KEIHIN/PWK GICLEUR BASE 45 KEIHIN/PWK					X	X	3,80 €
	372.1048	CHICLE MIN. KEIHIN/PWK 48 LOW JET 48 KEIHIN/PWK GICLEUR BASE 48 KEIHIN/PWK					X	X	3,80 €
	372.1052	CHICLE MIN. KEIHIN/PWK 52 LOW JET 52 KEIHIN/PWK GICLEUR BASE 52 KEIHIN/PWK					X	X	3,80 €

SUDADERA RACING	Color negro contrastada con capucha roja. Cordones anchos y planos, bolsillo canguro. 80% Algodón, 20% Poliéster.		
RACING SWEATSHIRT	Contrasted black and red hoodie. Wide and flat laces. Kangaroo pocket. 80% cotton, 20% polyester.		
SWEAT-SHIRT RACING	Contrasté noir avec capuche rouge. Lacets larges et plats, Poche kangourou. 80% coton, 20% polyester		
	X03S	SUDADERA RACING - TALLA S RACING SWEATSHIRT - SIZE S SWEAT-SHIRT RACING - TAILLE S	35,00 €
	X03M	SUDADERA RACING - TALLA M RACING SWEATSHIRT - SIZE M SWEAT-SHIRT RACING - TAILLE M	35,00 €
	X03L	SUDADERA RACING - TALLA L RACING SWEATSHIRT - SIZE L SWEAT-SHIRT RACING - TAILLE L	35,00 €
	X03XL	SUDADERA RACING - TALLA XL RACING SWEATSHIRT - SIZE XL SWEAT-SHIRT RACING - TAILLE XL	35,00 €
	X03XXL	SUDADERA RACING - TALLA XXL RACING SWEATSHIRT - SIZE XXL SWEAT-SHIRT RACING - TAILLE XXL	35,00 €

CAMISETA RACING	Color negro, 100% Algodón. Punto liso, 165g/m.		
RACING T-SHIRT	Black color, 100% cotton. Plaine 165g/m.		
T-SHIRT RACING	Couleur noir, 100% coton. Lisse 165g/m.		
	X01M	CAMISETA RACING - TALLA M RACING T-SHIRT - SIZE M T-SHIRT RACING - TAILLE M	15,00 €
	X01L	CAMISETA RACING - TALLA L RACING T-SHIRT - SIZE L T-SHIRT RACING - TAILLE L	15,00 €
	X01XL	CAMISETA RACING - TALLA XL RACING T-SHIRT - SIZE XL T-SHIRT RACING - TAILLE XL	15,00 €
	X01XXL	CAMISETA RACING - TALLA XXL RACING T-SHIRT - SIZE XXL T-SHIRT RACING - TAILLE XXL	15,00 €

CAMISETA MUJER 1989/BLANCO	Color blanco vigoré, 85% Algodón, 15% Viscosa		
1989/WHITE WOMEN'S T-SHIRT	Color white, 85% cotton, 15% viscose		
T-SHIRT FEMME 1989/BLANC	Couleur blanc. 85% coton, 15% viscose		
	X07M	CAMISETA MUJER 1989/BLANCA - TALLA M 1989/WHITE WOMEN'S T-SHIRT - SIZE M T-SHIRT FEMME 1989/BLANC - TAILLE M	15,00 €
	X07L	CAMISETA MUJER 1989/BLANCA - TALLA L 1989/WHITE WOMEN'S T-SHIRT - SIZE L T-SHIRT FEMME 1989/BLANC - TAILLE L	15,00 €
	X07XL	CAMISETA MUJER 1989/BLANCA - TALLA XL 1989/WHITE WOMEN'S T-SHIRT - SIZE XL T-SHIRT FEMME 1989/BLANC - TAILLE XL	15,00 €
	X07XXL	CAMISETA MUJER 1989/BLANCA - TALLA XXL 1989/WHITE WOMEN'S T-SHIRT - SIZE XXL T-SHIRT FEMME 1989/BLANC - TAILLE XXL	15,00 €

CAMISETA 1989/NEGRA		Color negro vigoré, 85% Algodón, 15% Viscosa	
1989/BLACK T-SHIRT		Color black, 85% cotton, 15% viscose	
T-SHIRT 1989/NOIR		Couleur noir. 85% coton, 15% viscose	
	X08M	CAMISETA 1989/NEGRA - TALLA M 1989/BLACK T-SHIRT - SIZE M T-SHIRT 1989/NOIR - TAILLE M	15,00 €
	X08L	CAMISETA 1989/NEGRA - TALLA L 1989/BLACK T-SHIRT - SIZE L T-SHIRT 1989/NOIR - TAILLE L	15,00 €
	X08XL	CAMISETA 1989/NEGRA - TALLA XL 1989/BLACK T-SHIRT - SIZE XL T-SHIRT 1989/NOIR - TAILLE XL	15,00 €
	X08XXL	CAMISETA 1989/NEGRA - TALLA XXL 1989/BLACK T-SHIRT - SIZE XXL T-SHIRT 1989/NOIR - TAILLE XXL	15,00 €

YP001	ADHESIVO PARAPENTE 70 x 30 cm. (RIPSTOP NEGRO) PARAGLIDING STICKER 70 x 30 cm. (BLACK RIPSTOP) AUTOCOLLANTS PARAPENTE 70 x 30 cm. (RIPSTOP NOIR)	32,80 €
YP002	ADHESIVO PARAPENTE 90 x 40 cm. (RIPSTOP NEGRO) PARAGLIDING STICKER 90 x 40 cm. (BLACK RIPSTOP) AUTOCOLLANTS PARAPENTE 90 x 40 cm. (RIPSTOP NOIR)	43,75 €

EPX001	JUEGO DE ADHESIVOS LOGO PAP GRIS Y ROJO (8,5CM X 3,5CM) OUTER STICKER PAP LOGO GREY AND RED (8,5CM X 3,5CM) JEU AUTOCOLLANTS EXTÉRIUR LOGO PAP GRIS ET ROUGE (8,5CM X 3,5CM)	2,00 €

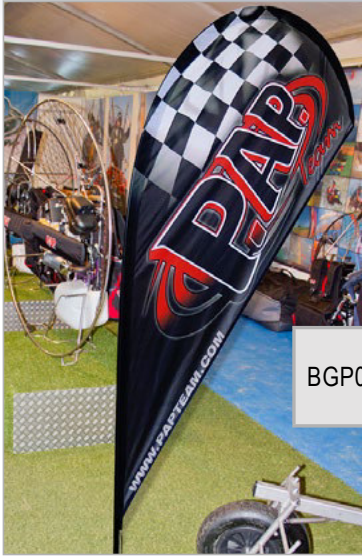

BGP001

BANDERA GOTA PUBLICITARIA 221X110 cms. (SIN KIT SOPORTE)
 DROP FLAG 221X110 cms. (WITHOUT SUPPORT KIT)
 DRAPEAU GOUTTE 221X110 cms. (SANS KIT SUPPORT)

95,00 €



BGP002

KIT SOPORTE (BANDERA GOTA PUBLICITARIA 221X110 cms.)
 SUPPORT KIT (DROP FLAG 221X110 cms.)
 KIT SUPPORT (DRAPEAU GOUTTE 221X110 cms.)

98,90 €